

DPI 610E DPI 610E-IS

Portable Pressure Calibrator Instruction Manual



DPI 610E-PC



DPI 610E-SPC



DPI 610E-HC



DPI 610E-SHC

Contents

1.	Overview	9
1.1	DPI 610E Series	9
1.1.1	Firmware Versions	9
1.2	Equipment in the Box	11
1.2.1	Pneumatic Units	11
1.2.2	Hydraulic Units	11
1.3	Specifications for DPI 610E	11
1.4	Accessories	12
1.5	Observance of Manual	12
1.6	Safety	12
1.6.1	General Safety Precautions	13
1.6.2	Operation in a Hazardous Environment	13
1.6.3	General Warnings	13
1.6.4	Electrical Warning	13
1.6.5	Pressure Warnings	14
1.6.6	Overvoltage Categories	14
1.7	Maintenance	15
1.7.1	Visual Inspection	15
1.7.2	Cleaning	15
1.7.3	Calibration	15
1.8	Service and Repair	15
1.9	Spares	16
1.10	Instrument Return	16
1.10.1	Returned Goods Procedure	16
1.10.2	Instrument Disposal	16
1.11	Packaging For Storage or Transportation	16
1.11.1	Environment	16
1.12	Preparing the Instrument	17
1.12.1	Initial Checks	17
1.13	Battery and Charging	17
1.13.1	Battery Status Indicator	18
1.14	Power ON/OFF	18
1.14.1	Power ON	18
1.14.2	Power OFF	18
1.14.3	Auto Power Down	18
1.15	Parts	19
1.15.1	Test Port	21
1.15.2	Reservoir (Hydraulic Version)	21
1.15.3	Pressure Release Valve	21
1.15.4	Electrical Connections	21
1.15.5	Handle and Shoulder Strap	21
1.15.6	Pump (Pneumatic Version)	21
1.15.7	Priming Pump (Hydraulic Version)	21
1.15.8	Volume Adjuster (Pneumatic Version)	21
1.15.9	Volume Adjuster Wheel (Hydraulic Version)	21
1.15.10	Pressure/ Vacuum Selector (Pneumatic Version)	21
1.15.11	Auxiliary Ports	21
1.15.12	External Sensor Port	21
1.15.13	Barometric Port (Pneumatic Version only)	22

1.16	Label on Instrument Base.	22
1.17	User Interface	23
	1.17.1 Buttons and softkeys	23
1.18	First Use	24
1.19	Dashboard	24
	1.19.1 Dashboard Softkeys	24
	1.19.2 Dashboard Navigation	25
	1.19.3 Set Date, Time and Language	25
2.	Pump Operations	27
2.1	Pneumatic System	27
	2.1.1 Use of Blanking Plug	27
	2.1.2 Flexible hose	27
	2.1.3 Venting to atmosphere	27
	2.1.4 Attach Instrument Dirt (and Water) Trap to Test Port	28
	2.1.5 Attach/Remove Device Under Test	28
	2.1.6 Preparing the instrument for Pressure/Vacuum operation	30
	2.1.7 Generating Pressure/Vacuum	31
2.2	Hydraulic System	34
	2.2.1 Filing the reservoir	34
	2.2.2 Priming the Instrument	35
	2.2.3 Generating Pressure	39
	2.2.4 Releasing Pressure	39
	2.2.5 How to achieve 400 bar	39
3.	Basic Tasks	40
3.1	Tasks	40
	3.1.1 P-I (Pressure to Current measure)	40
	3.1.2 P-P (Pressure to Pressure)	40
	3.1.3 P-V (Pressure to Voltage)	41
	3.1.4 I-P (Pressure to Current source)	41
	3.1.5 P-Display (Pressure to Display)	41
	3.1.6 Leak Test	41
	3.1.7 Switch Test	41
	3.1.8 TX SIM (Transmitter Simulation)	41
	3.1.9 Relief Valve Test	41
3.2	Tasks Selection	42
3.3	Adding Tasks to the Dashboard	42
3.4	Removing Tasks from the Dashboard	42
4.	General Settings	43
4.1	DATE, TIME and LANGUAGE	43
4.2	BACKLIGHT	44
4.3	USB	45
4.4	AUTO POWER DOWN	46
4.5	TOUCHSCREEN LOCK	48
4.6	ENABLE HOLD	49
4.7	ADVANCED	50

5.	Advanced Menu	52
5.1	CALIBRATION Menu	53
5.2	CHANGE PIN	54
5.3	SOFTWARE UPGRADE	55
	5.3.1 How to load a Software Upgrade File	55
	5.3.2 How to upgrade the Firmware	57
5.4	FACTORY RESET	59
5.5	FORMAT FILE SYSTEM	61
5.6	SERVICE / ENGINEERING	62
6.	Calibrator Tasks	63
6.1	Calibrator Task Screen	63
	6.1.1 Calibrator Tasks Screen Shortcuts	64
	6.1.2 Error Indications	70
6.2	Functions	71
	6.2.1 Functions available by channel	71
	6.2.2 None	73
	6.2.3 Pressure	73
	6.2.4 Sum	80
	6.2.5 Difference	82
	6.2.6 Barometer	84
	6.2.7 Observed	86
	6.2.8 RTD	87
	6.2.9 Current	88
	6.2.10 Voltage	104
	6.2.11 Millivolts Measure - Configuration	106
	6.2.12 HART	108
6.3	Process Options	110
	6.3.1 Tare	110
	6.3.2 Min/Max/Mean	112
	6.3.3 Filter	115
	6.3.4 Flow	117
	6.3.5 Alarm	119
	6.3.6 Scaling	122
7.	Utilities	129
7.1	Leak Test	129
7.2	Switch Test	134
7.3	TX (Transmitter Simulation) Simulator	137
7.4	Relief Valve Test	139
8.	External Sensors	141
8.1	PM700E	141
	8.1.1 Overview	141
	8.1.2 Media Compatibility	141
	8.1.3 Setup	142
	8.1.4 The Zero Function	143
	8.1.5 Available External Pressure Sensors	143
	8.1.6 Configuration of an External Pressure Sensor	144
8.2	RTD Probe and Interface	147
	8.2.1 Overview	147

8.2.2	Temperature Considerations	147
8.2.3	Setup	148
8.2.4	Configuration of a channel for a RTD sensor	150
8.2.5	RTD Profiles	152
9.	Data Log	155
9.1	Data Log Setup Menu	155
9.1.1	How to set the Data Log Filename	156
9.2	TRIGGER Menu	158
9.3	Periodic Trigger Options	159
9.3.1	TIME INTERVAL	159
9.3.2	LOG DURATION	161
9.3.3	DATA POINTS	162
9.4	Setting up Manual Data Logging	164
9.5	Setting up Periodic Data Logging	166
9.6	Viewing & Deleting Data Log files	167
9.6.1	Viewing Data Log Files	167
9.6.2	How to use a PC to view Data Log files in the DPI 610E	168
9.6.3	Deleting Data Log Files	169
9.7	How to transfer a Data Log file	172
10.	Analysis	174
10.1	Overview	174
10.2	Analysis Setup	174
10.3	Function	175
10.3.1	START/END Values	175
10.3.2	LINEARITY	175
10.3.3	ERROR TYPE	176
10.3.4	TOLERANCE	176
10.4	Analysis Function	176
10.4.1	DATA LOGGING within Analysis	177
11.	Documenting	178
11.1	Overview	178
11.1.1	How to start the Documenting application	178
11.2	INTERNAL PROCEDURES	178
11.2.1	How to select the INTERNAL PROCEDURES mode	178
11.2.2	How to create an Internal Procedure	179
11.2.3	How to start a Test Procedure	186
11.2.4	How to delete a Test Procedure	186
11.2.5	Additional Data Required	187
11.2.6	How to proceed after input of additional data	190
11.3	The Documenting Main Screen	192
11.4	Documenting Settings	194
11.5	Example Testing Session	196
11.6	Post Examination of Test Procedure Results	198
11.7	Making an adjustment on the Device Under Test (DUT)	199
11.8	How to redo a Test Procedure	200
11.9	How to View Test Results.	201
11.10	Deleting Asset Data	203
11.11	How to use the Calibration Certificate Wizard	203

12.	HART	205
12.1	HART® Connection	205
12.1.1	Starting the HART application (1st Method)	205
12.1.2	Starting the HART application (2nd Method)	207
12.1.3	HART device electrical connection	208
12.2	HART Device Configuration	209
12.3	HART Dashboard	214
12.3.1	Unique ID	215
12.3.2	Device Information	215
12.3.3	Measure Variables	216
12.3.4	Signal Condition	216
12.3.5	Sensor Information	217
12.4	HART Service Methods	218
12.4.1	LOOP TEST	218
12.4.2	D/A OUTPUT TRIM	220
12.4.3	PRESSURE ZERO TRIM	224
12.5	HART Error and Message Codes	225
13.	Instrument Calibration	226
13.1	How to show the Instrument Calibration screen	226
13.1.1	The Instrument Calibration screen options	228
13.2	PERFORM CALIBRATION	229
13.2.1	Calibration - Electrical Functions	229
13.2.2	Calibration - Internal Pressure Sensor	234
13.2.3	Calibration – Internal Barometer	238
13.3	INTERNAL PRESSURE SENSOR STATUS	242
13.4	SET CALIBRATION DATE & INTERVAL	243
13.4.1	Change Last Calibration Date	244
13.4.2	Change Calibration Interval	245
13.4.3	Change Calibration Due Date	246
13.5	BACKUP CALIBRATION	247
13.6	RESTORE CALIBRATION	248
13.7	RESTORE FACTORY CALIBRATION	249
13.8	EXTERNAL PRESSURE SENSOR CALIBRATION MENU	250
13.8.1	PERFORM CALIBRATION	250
13.8.2	VIEW EXTERNAL PRESSURE SENSOR STATUS	251
13.8.3	SET CALIBRATION DATE & INTERVAL	252
13.9	EXTERNAL RTD SENSOR CALIBRATION MENU	256
13.9.1	PERFORM CALIBRATION	256
13.9.2	SET CALIBRATION DATE & INTERVAL	260
14.	File System	264
14.1	How to access the Files system menu	264
14.1.1	The Files system screen options	265
14.2	Calibration	265
14.3	Data Log	266
14.4	Procedures	266
14.5	Leak Test	267
14.6	Switch Test	267
14.7	Relief Valve	268
14.8	How to view the File System on a PC	268

14.9	Favorites, Error Log and Event Log	269
15.	Status Menu	270
15.1	Status Menu Options	270
15.2	How to show the Status menu screen	270
15.3	SOFTWARE BUILD	271
15.4	CALIBRATION	272
15.5	BATTERY	273
15.6	MEMORY	274
15.7	SENSOR	275
15.8	ERROR LOG	276
	15.8.1 How to export and view Exported Error Log files	276
15.9	EVENT LOG	277
	15.9.1 How to export and view Exported Event Log files	277
16.	General Specification	278
16.1	Open Source Software Licenses	278
17.	Manufacturer	279
17.1	Contact details	279

1. Overview

The DPI 610E series instrument comprises a portable pressure calibrator with an in-built pressure generation manual pump, with pressure measurement and simulation capability. It is intended to be used to calibrate pressure sensors and transmitters. It has a smart and simple user interface allowing it to be operated by any technician, service or maintenance engineer.

The DPI 610E series combines a practical and robust design with reliable and accurate measurements. It is battery-powered and features highly reliable pneumatic and hydraulic assemblies for continuous and reliable performance for field calibration, even in harsh environmental conditions.

A flexible hose is supplied with the instrument to enable connection to other equipment.

This calibrator is enhanced with data logging functionality with reliable internal memory for secure file storage.

The analysis feature includes field error calculations with PASS/FAIL status with the ability to create or download procedures that can be run on multiple devices, providing calibration certification for asset management and maintenance purposes.

The DPI 610E supports the HART (Highway Addressable Remote Transducer) communication protocol and allows basic HART operation and configuration on HART supported devices.

1.1 DPI 610E Series

1.1.1 Firmware Versions

This manual is based on the use of application firmware DK0492 version V01.00.10. For further details see End User Software Release Note document **169M2231** available at Druck.com/DPI610E.

Table 1-1: DPI 610E Series

Product Name	Case Color	Pressure Range	Calibrator Type
DPI 610E-PC	Blue	0.35 bar - 35 bar (5 - 500 psi) (0.035 MPa - 3.5 MPa)	Pneumatic
DPI 610E-SPC	Yellow	0.35 bar - 35 bar (5 - 500 psi) (0.035 MPa - 3.5 MPa)	Pneumatic - Intrinsically Safe
DPI 610E-HC	Blue	70 bar - 1000 bar (1000 psi - 15000 psi) (7 MPa - 100 MPa)	Hydraulic
DPI 610E-SHC	Yellow	70 bar - 1000 bar (1000 psi - 15000 psi) (7 MPa - 100 MPa)	Hydraulic- Intrinsically Safe

Photographs of these Calibrator types are on the next page.



Model: DPI 610E-PC
Type: Pneumatic
Pressure Range: 0.35 - 35 bar,
5 - 500 psi, 0.035 - 3.5 MPa



Model: DPI 610E-SPC
Type: Pneumatic - Intrinsically Safe
Pressure Range: 0.35 - 35 bar,
5 - 500 psi, 0.035 - 3.5 MPa



Model: DPI 610E-HC
Type: Hydraulic
Pressure Range: 70 - 1000 bar,
1000 - 15000 psi, 7 - 1000 MPa



Model: DPI 610E-SHC
Type: Hydraulic - Intrinsically Safe
Pressure Range: 70 - 1000 bar,
1000 - 15000 psi, 7 - 1000 MPa

1.2 Equipment in the Box

The following items are supplied with the instruments in the DPI 610E series. When unpacking the instrument, make sure that there are no missing items.

Note: The hydraulic instrument has a protective cap in the reservoir socket. Keep this cap for future use: this is for sealing the socket when no reservoir is attached.

1.2.1 Pneumatic Units

1. DC Power Supply (IO610E-PSU)
2. BSP Swivel Adapter (184-203)
3. NPT Swivel Adapter (184-226)
4. Blanking Plug (111M7272-1)
5. (IDT) Instrument Dirt Trap (IO620-IDT621-NEW) - packed separately, OR (IDT) Instrument Dirt Trap (IO620-IDT621-IS) - packed separately
6. Hose sets: 1m (IO620-HOSE-P1) or Intrinsically Safe (IO620-HOSE-P1-IS)
7. Electrical Test Lead Set (IO6X-LEAD)
8. 2m USB Cable (IO610E-USB-CABLE)
9. DPI 610E Quick Start and Safety Manual (165M0437)
10. Certificates Document Pack (IS product only)
11. Factory Calibration Certificate.

1.2.2 Hydraulic Units

1. DC Power Supply (IO610E-PSU)
2. BSP Swivel Adapter (184-203)
3. NPT Swivel Adapter (184-226)
4. Blanking Plug (111M7272-1)
5. Hose sets: 1m long (IO620-HOSE-H1) or Intrinsically Safe (IO620-HOSE-H1-IS)
6. Reservoir (PV411-115 or Intrinsically Safe PV411-115-IS) - packed separately
7. 250 ml Reservoir Filler Bottle (1S-11-0085)
8. Electrical Test Lead Set (IO6X-LEAD)
9. 2m USB Cable (IO610E-USB-CABLE)
10. DPI 610E Quick Start and Safety Manual (165M0437)
11. Certificates Document Pack (IS product only)
12. Factory Calibration Certificate.

1.3 Specifications for DPI 610E

Refer to www.druck.com/dpi610e for the Datasheet that gives the technical specifications for the DPI 610E.

1.4 Accessories

Table 1-2 shows common accessories for the DPI 610E series. See Datasheet (BHCS39207) for a full list of accessories.

Table 1-2: Common accessories

Part Code	Description
RTD-INTERFACE-485	RTD Interface only (IS area)
RTD-INTERFACE-IS	RTD IS Interface (non-IS area)
RTD-PROBE-485	RTD Interface with PT100 Probe (IS)
RTD-PROBE-IS	RTD Interface with PT100 Probe (non-IS area)
IO-RTD-M12CON	M12 Field Wireable Connector to fit RTD Interface (IS and non-IS area)
IO-RTD-M12EXT	RTD M12 male to female extension lead 2 m (6.5 ft) 4-wire
IO-RTD-PRB150	150 mm length 6 mm diameter PT100 steel RTD probe, Class A
PM700E	Remote Pressure Sensor (IS area)
PM700E-IS	Remote Pressure Sensor (non-IS area)
PM700E-CABLE	Remote Sensor Extension Cable 2.9 m (9.5 ft)
IO620-IDT621-NEW	Bar Dirt and Moisture Trap (IS area)
IO620-IDT621-IS	Bar Dirt and Moisture (non-IS area)
IO610E-CASE	Carrying Case (suitable for IS and non-IS use)

1.5 Observance of Manual



INFORMATION This manual contains operating procedures and safety information for the DPI 610E series. It is the responsibility of the customer to make sure that all personnel operating and maintaining the equipment are correctly trained and qualified.

Note: Before operating or using the equipment, read and obey all warnings and cautions given in the Quick Start and Safety Manual.

1.6 Safety



INFORMATION The manufacturer has designed this equipment to be safe when used as detailed in this manual. Operators should read and obey all local Health and Safety regulations and Safe Working Procedures or Practices.

When performing a procedure or task:

1. Do not use this instrument for any other purpose than stated in this manual. Incorrect use may impair safety.
2. Follow all operating and safety instructions in the Quick Start and Safety Manual.
3. Use suitably qualified Technicians and good engineering practice for all procedures in this documentation.

1.6.1 General Safety Precautions

- Use only the approved tools, consumable materials and spares to operate and maintain the equipment.
- Make sure all work areas are clean and clear of unwanted tools, equipment and materials.
- Make sure all unwanted consumable materials are discarded in accordance with local health and safety and environmental regulations.

1.6.2 Operation in a Hazardous Environment



WARNING Do not use the DPI 610E-HC or DPI 610E-PC in locations where explosive gas, vapor or dust are present. There is a risk of an explosion.

Refer to the Quick Start and Safety Manual provided with the instrument.

1.6.3 General Warnings



Make sure that the instrument is safe to use with the proposed media. Some liquid and gas mixtures are dangerous. This includes mixtures that result from contamination.

Do not use in an enriched oxygen environment or with other strong oxidizers - this can cause an explosion.

Do not use tools on the instrument that might cause incendive sparks - this can cause an explosion.

It is dangerous to ignore the specified limits (refer to data sheet) for the DPI 610E series or to use the instrument when it is not in its normal condition. Use the applicable protection and obey all safety precautions.

1.6.4 Electrical Warning



RISK OF ELECTRIC SHOCK To prevent electrical shocks or damage to the instrument, do not connect more than 30 V CAT I between the terminals, or between the terminals and the ground (earth). Any connection must be compliant with the terminal input/output parameters.

External circuits should have appropriate insulation to the mains.



WARNING This instrument uses a Lithium-Ion (Li-Ion) battery pack. To prevent an explosion or fire, do not short circuit and do not disassemble. Keep the battery safe from damage.



WARNING To prevent an explosion or fire, only use the Druck specified battery (150M8295-1) and power supply (149M4334-1) rated for this instrument.

To prevent battery leakage/damage or excess heat generation, only use the mains power supply in the ambient temperature range 0 to 40°C (32 to 104°F). The power supply input range is 90 – 264 VAC, 50 to 60 Hz, 300 mA, installation category CAT II.

Note: Position the power supply without obstructing the supply disconnecting device.

Note: The instrument is suitable for short-term and long-term temporary overvoltage that may occur between the line conductor and earth in electrical installations.

Note: Keep all leads free from contaminants.

1.6.5 Pressure Warnings



INFORMATION The instrument contains an internal over-pressure vent mechanism to protect the internal pressure sensor and pump mechanism from damage.

Note: Maximum Operating Pressure (MWP) is stated on the label on the underside of the instrument. Over pressure should be limited to $1.5 \times \text{MWP}$ (MWP is based on unit pressure range).



WARNING Always wear appropriate eye protection when working with pressure.

To prevent a dangerous release of pressure, make sure that all the related pipes, hoses and other accessories have the correct pressure rating, are safe to use and are correctly attached. Isolate and bleed the system before you disconnect a pressure connection.

It is dangerous to attach an external source of pressure to the instrument. Use only the internal mechanisms to set and control pressure in the pressure station.

1.6.6 Overvoltage Categories

The following summary of installation and measurement overvoltage categories is derived from IEC610101. The overvoltage categories indicate the severity of overvoltage transients.

Table 1-3: Overvoltage Categories

Category	Description
CAT I	This is the least severe overvoltage transient. CAT I equipment cannot be directly connected to the mains power: for example, a process loop powered device.
CAT II	This is for single phase electrical installation. For example, appliances and portable tools.

1.7 Maintenance

Maintain the instrument using the procedures outlined in this User Manual and for information relating to maintenance issues please contact:

www.bakerhughesds.com/druck/global-service-support

Table 1-4 summarizes manufacturer recommended maintenance tasks for the DPI 610E series.

Table 1-4: Maintenance Tasks

Task	Period
Visual Inspection	Before Use
Cleaning	Determined by usage
Calibration	12 months (recommended)

1.7.1 Visual Inspection

Inspect the instrument before use, checking for signs of damage (e.g case cracking, pressure connector damage or pressure leakage), to ensure continued safe working.

1.7.2 Cleaning

Clean the surface of the instrument should using a damp cloth with water and mild detergent. Do not submerge the instrument in water.

1.7.3 Calibration

To calibrate the instrument, please contact www.bakerhughesds.com/druck/global-service-support

1.8 Service and Repair



WARNING Servicing or repairing the equipment may result in damage to property and serious personal injury (including death). It is important that service and repair are only done by a Druck authorized service provider.

Repair activities undertaken by unauthorized personnel may invalidate the equipment warranty. Druck cannot be held liable for any damage (including damage to the equipment), monetary fine or personal injury (including death) that may occur during or as a result of service maintenance or repair work undertaken by an unauthorized service provider.

Internal components, such as the Lithium battery pack, may be under pressure or create other hazards if abused.

For more details, please see www.bakerhughesds.com/druck/global-service-support

1.9 Spares

For advice or technical support relating to spare parts, please contact:

drucktechsupport@BakerHughes.com

1.10 Instrument Return

1.10.1 Returned Goods Procedure

If the unit requires calibration or is unserviceable, please return it to the nearest Druck Service Centre listed at: <https://www.bakerhughes.com/druck>

Contact the Service Centre to obtain a Return Goods Authorization (RGA). If you are in the USA, obtain a Return Material Authorization (RMA).

Provide the following information on either a RGA or RMA:

- Product code
- Serial number
- Details of defect/work to be undertaken
- Error code(s) if applicable
- Operating conditions.

1.10.2 Instrument Disposal

Do not dispose of this product as household waste. Use a Recycling Passport for the product. This can be downloaded from the product web page:

<https://www.Druck.com/expert>. Use an approved organization that collects and/or recycles redundant electrical and electronic equipment.

For more information contact either our Customer Service Department (<https://www.bakerhughes.com/druck>) or your local government office.

1.11 Packaging For Storage or Transportation

1.11.1 Environment

The equipment must be maintained in the conditions shown in Table 1-5. This applies for both shipping and storage.

Table 1-5: Conditions for Storage and Transportation

Condition	DPI 610-E	Mains Plug 149M43341
Outdoor use	Not for permanent installation outdoors	For indoor use only
IP rating	IP54	IP20
Operating temperature	-10 to 50°C	-10 to 50°C
Storage and shipping temperature	-20 to 70°C	-20 to 70°C
Altitude	-300 to 2000m	-300 to 2000m
Operating humidity	0 to 95% relative humidity (RH) non-condensing	0 to 95% relative humidity (RH) non-condensing
Pollution degree	1	1

1.12 Preparing the Instrument



INFORMATION When you receive the instrument, check that the box contains the items listed in Section 1.2, “Equipment in the Box,” on page 11. It is recommended that you retain the box and packaging for future use.

1.12.1 Initial Checks

- Visual check (for cracks/defects)
- Do not use any equipment that you know is damaged or faulty
- Ensure the battery is charged (see Section 1.13).

1.13 Battery and Charging

The instrument contains a rechargeable Li-ion battery. To charge the battery, plug the power supply into the DC charging port located under the protection flap, at the top of the instrument.

The instrument can also be charged from any vehicle with a standard 12 V accessory socket with an IO610E-CAR CHARGER (optional accessory).

The instrument can be charged while switched on and also when powered off. Battery charge time is approximately two hours from empty to fully charged.

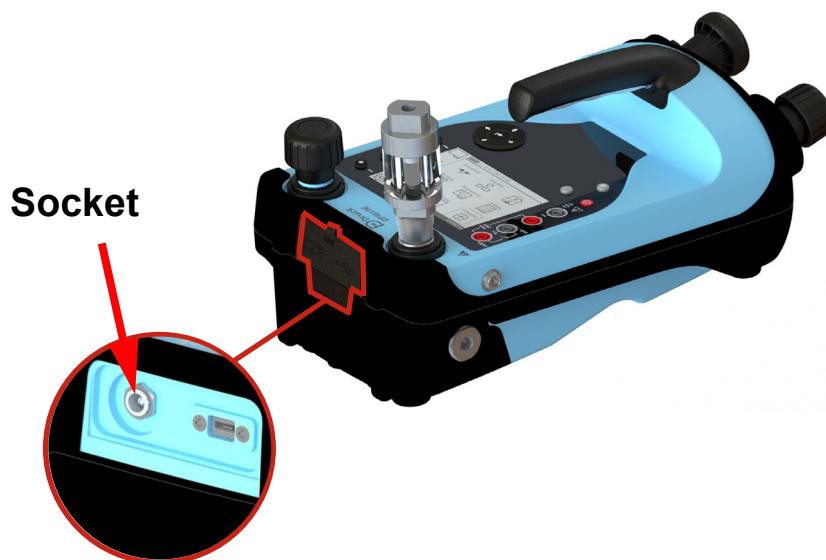

Figure 1-1: Battery Charging Socket

Chapter 1. Overview

1.13.1 Battery Status Indicator



The battery status indicator (located at the right hand side of instrument) provides a visual indication of the battery level, even when the instrument is off. Press the circular button on the right of the display to show the charge: the display will automatically close down. Each LED represents approximately 25% battery capacity.

1.14 Power ON/OFF

1.14.1 Power ON

To switch the instrument ON, hold down the power button  for about 2 seconds, until the Druck Logo splash screen appears.

1.14.2 Power OFF

To switch the instrument OFF, hold down the power button  for about 4 seconds until the closing screen appears.

1.14.3 Auto Power Down

The instrument has an Auto Power Down feature that can be enabled/deactivated as required. See General Settings Section 4 on page 43: (on the instrument it can be found under the **General**

Settings  screen on the Dashboard).

1.15 Parts

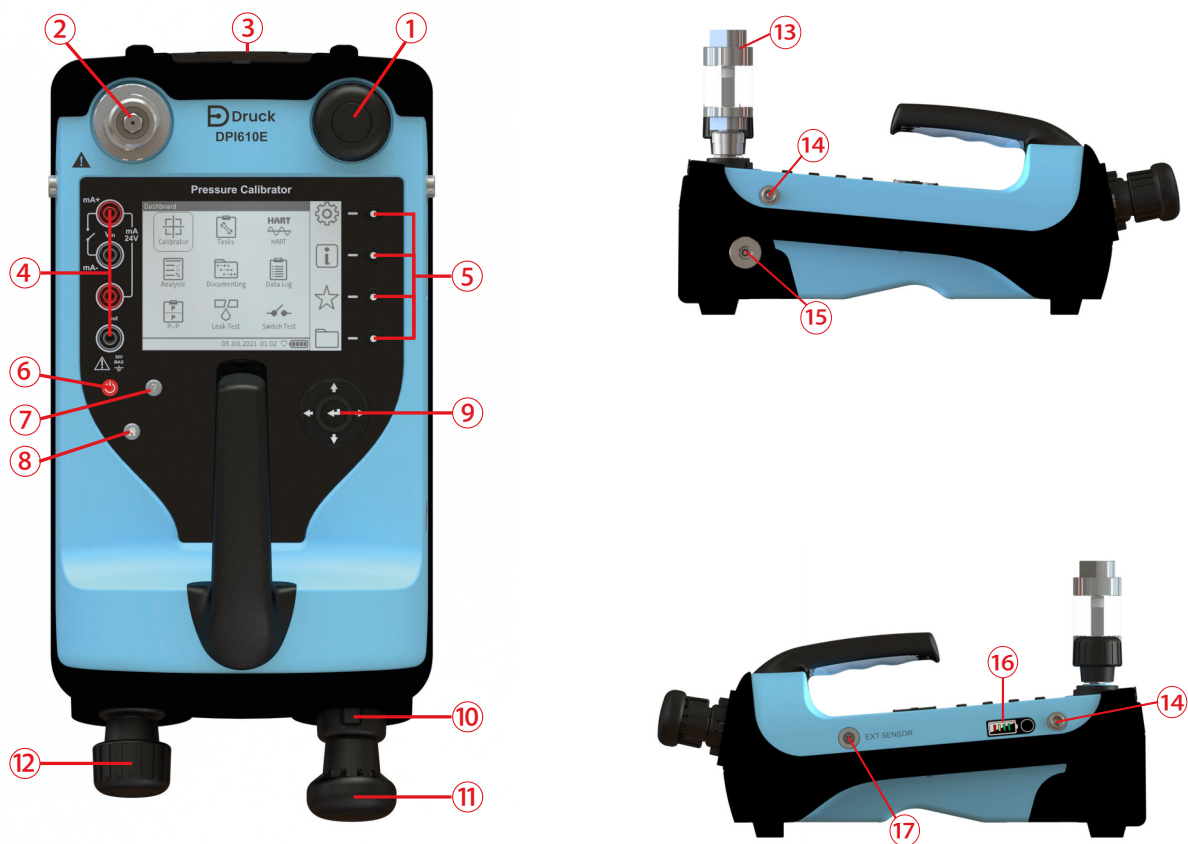

Pneumatic version

Number	Item	Number	Item
1	Pressure Release Valve	10	Pressure/Vacuum Selector
2	Test Port (including Swivel Connector)	11	Pressure/Vacuum Hand Pump
3	Auxiliary Ports (DC power supply port Battery Charging, USB micro port.	12	Volume Adjuster (Fine control of pressure)
4	Electrical 4mm sockets	13	Instrument Dirt (& Fluid) Trap (IDT)
5	Screen Selection softkeys	14	Clip Fastener for Carrying Strap
6	Power ON/OFF button	15	Barometer Port
7	Help Button	16	Battery Level Indicator (One bar equals 25% charge)
8	Home Button	17	External Sensor Port
9	Navigation Pad		

Chapter 1. Overview



Hydraulic version

Number	Item	Number	Item
1	Hydraulic Reservoir	9	Navigation pad
2	Test Port (including swivel connector)	10	Pressure Hand Pump
3	Auxiliary Ports (DC power supply port Battery Charging, USB micro port.	11	Volume Adjuster Wheel (Fine control of pressure)
4	Electrical 4mm Sockets	12	Clip Fastener for Carrying Strap
5	Screen Selection softkeys	13	Pressure Release Valve
6	Power ON/OFF button	14	Battery Level Indicator (One bar equals 25% charge)
7	Help button	15	External Sensor Port
8	Home button		

1.15.1 Test Port

The Test Port is at the top left corner of the instrument. Pressure can be generated and supplied to pressure devices that are connected either directly or using compatible hose fittings.

1.15.2 Reservoir (Hydraulic Version)

Ensure the Reservoir is filled with the correct hydraulic fluid before use. Recommended fluid ISO viscosity grade ≤ 22 , such as demineralized water or mineral oil.

1.15.3 Pressure Release Valve

The Pressure Release valve is on the top right of the instrument for the Pneumatic version and on the left side for the Hydraulic version. To release all pressure within the instrument, slowly open the pressure release valve by turning it counter-clockwise. Make sure the system is sealed before pressure generation by completely closing the pressure release valve in the clockwise direction.

1.15.4 Electrical Connections

Four electrical 4mm sockets are on the left side of the instrument glass face. These are labeled for different electrical measurement or source functions.

1.15.5 Handle and Shoulder Strap

The DPI 610E has a carry handle to allow for a steady grip on the instrument, while the shoulder strap can be used for more comfortable use.

1.15.6 Pump (Pneumatic Version)

When the pump selector is in the (+) orientation the hand pump generates pressure by a forward-backward stroke action. When the pump selector is in the (-) orientation the pump creates a vacuum by a backward-forward stroke action. To prevent damage to the unit the system must be fully vented before switching between vacuum and pressure.

1.15.7 Priming Pump (Hydraulic Version)

The priming pump is used to draw hydraulic fluid from the reservoir and force air, gas or vapor present out of the system.

1.15.8 Volume Adjuster (Pneumatic Version)

The volume adjuster is used to control the pressure for fine adjustments.

1.15.9 Volume Adjuster Wheel (Hydraulic Version)

The volume adjuster wheel is used to adjust the pressure in the range of 20 - 1000 bar. To increase the pressure, turn the wheel clockwise. To decrease the pressure, turn the wheel counter-clockwise.

1.15.10 Pressure/ Vacuum Selector (Pneumatic Version)

The pressure/vacuum selector can be set to generate a pressure or a vacuum. To prevent damage to the unit the system must be fully vented before switching between vacuum and pressure.

1.15.11 Auxiliary Ports

The auxiliary ports are at the top of the instrument and enclosed within the rubberized flap. It accommodates a DC power supply port and a Micro USB port.

1.15.12 External Sensor Port

On the right side of the instrument is the RS485 communications port to enable connection of external remote sensors such as the PM700E pressure sensor and the RTD-Interface.

Chapter 1. Overview

1.15.13 Barometric Port (Pneumatic Version only)

The left side has a Barometer port that provides a static pressure inlet for the internal barometric pressure sensor.

1.16 Label on Instrument Base.

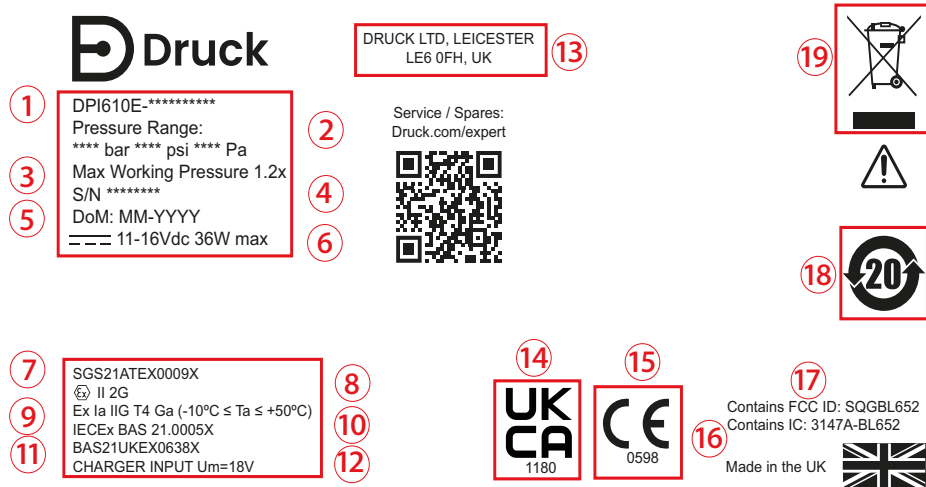

Note: Certification markings might be different on instrument, depending on model purchased.

Number	Item
1	Full code Identification of instrument.
2	Pressure range of instrument.
3	Maximum Working Pressure is 1.2 x value of top value of pressure range
4	Serial number of the instrument
5	Date of Manufacture: Month, Year
6	Current and Voltage rating for the instrument
7	ATEX Certificate Number
8	EU Directive 2014/34/EU Marking
9	EU Hazardous Area Marking
10	IECEx Certificate Number
11	UKEX Certificate Number
12	Current output of Charger
13	Full address of manufacturer of instrument
14	This mark indicates that this product complies with the Great Britain standard for the safety of products
15	This mark indicates that this product complies with the European standard for the safety of products.
16	Canada ISED Radio Approval ID (Bluetooth)
17	US FCC Radio Approval ID (Bluetooth)
18	China RoHS
19	WEEE (Recycling) Marking. Do not dispose of as normal refuse - take to an authorized disposal facility.

1.17 User Interface



Figure 1-2: Instrument User interface

The user interface (Figure 1-2) can be operated using the touchscreen, buttons or softkeys.

1.17.1 Buttons and softkeys

1.17.1.1 Power Button

The power button  is used to switch the instrument on and off. See Section 1.14, “Power ON/OFF,” on page 18.

1.17.1.2 Help Button

The Help button  provides relevant information on how to use the instrument. It is context-sensitive which means the information provided when the help button is pressed will be related to the specific screen or task in use at that moment in time. The Help button also provides a link and QR code to access the full user manual online through a smart device or PC.

1.17.1.3 Home Button

The **Home** button  acts as a shortcut key which enables quick navigation to the Dashboard home screen from anywhere in the user menu.

1.17.1.4 Enter button

An Enter button  is in the middle of the Navigation Pad.

1.17.1.5 Navigation Pad

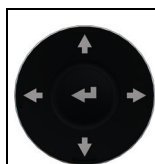

The Navigation Pad consists of Up, Down, Left, Right and Enter buttons which allow quick and easy navigation when using the user interface.

Chapter 1. Overview

1.17.1.6 Softkeys

	<p>There are four softkeys on the right side of the LCD display. These softkeys are context-sensitive and their use varies from screen to screen depending on the menu or task being accessed. Each softkey has a corresponding on-screen icon which provides a visual display of the purpose of that specific button as shown in Figure 1-2. The on-screen icons also act as touch-screen buttons for the same purpose as the corresponding softkey.</p>
---	---

1.18 First Use

Check that the default settings for the instrument are correct before the first use of the instrument: refer to Chapter 4, “General Settings,” on page 43 for how to set its default values. For example, it might be necessary to change the language for the user interface or the time and date.

1.19 Dashboard

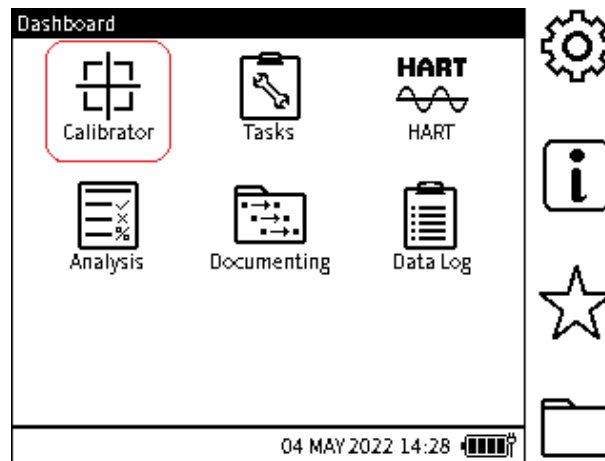

Figure 1-3: Instrument Dashboard

On power up, the instrument displays the Dashboard. The Dashboard is the home screen through which all functions, tasks and settings can be accessed. The Dashboard has icons which represent different applications. The Calibrator, Tasks, HART, Analysis, and Data Log icons are fixed and always present.

Note: If additional applications are configured on the instrument license, their respective icons will also be present and fixed on the Dashboard (See Chapter 4 on page 43).

1.19.1 Dashboard Softkeys

The dashboard softkey icons are on the right of the dashboard screen. The icons are ⚙️ General Settings, ⓘ Status, ☆ Favorites and 📁 File System. An icon is activated by either tapping the screen where it is or by pressing the softkey on the right of the icon.

Note: The icons on the sidebar are fixed on the Dashboard.



Be careful to avoid accidentally touching the display screen when using the instrument. This can make the system execute unintended actions. This can happen, for example, when pushing cables into the sockets in the face of the instrument or by letting cables touch the screen.

1.19.2 Dashboard Navigation

To access an application, the user should select the relevant icon on the touch screen. The user can also use the navigation buttons to navigate between icons on the dashboard as described in Section 1.17.1.5.

To access the icons on the side bar, select the relevant icon on the touch screen, or press the corresponding softkey.

Note: To return to the Dashboard, the user can select the home button <HOME>.

1.19.3 Set Date, Time and Language

1.19.3.1 Date and Time

To access the **Date/Time** menu screen (Figure 1-4), select:

Dashboard >>  General Settings >> TIME/DATE

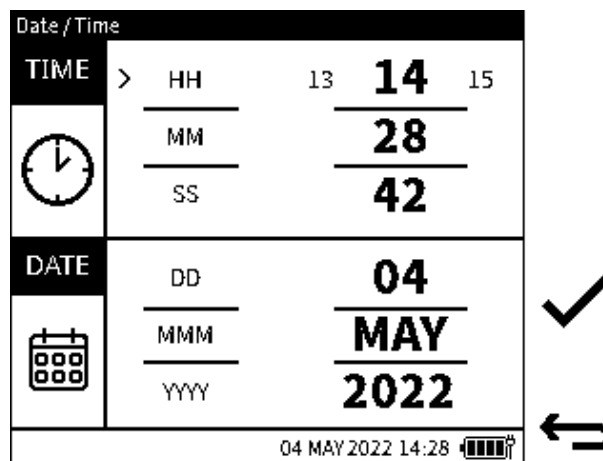



Figure 1-4: Time/Date Menu Screen

On the Navigation Pad, use the **UP/DOWN** navigation buttons to select the time and date parameters to be changed, then use the **LEFT/RIGHT** buttons to increase or decrease the values. If using the touchscreen, tap the required time or date parameter to be changed and then tap on the right side of the set value (in bold font) to increment or on the left side to decrement the value as required.

When all parameters have been selected press the **Tick**  softkey to accept the **Date/Time** changes or press the **Back**  button to exit without saving the changes.

1.19.3.2 Language

To access the **Language** menu (Figure 1-5), select:

Dashboard >>  General Settings >> Language



Figure 1-5: Language Menu Screen

Use the navigation buttons to select the desired language. If using the touchscreen, tap on the desired language option. Press the **Tick** ✓ softkey to accept the changes or select the **Back** ↶ softkey to exit without saving any changes.

1.19.3.3 Open Source Licenses

There are two files that relate to the software for upgrading the firmware for this instrument:

1568-notices-report-08_08_2022_17_04.txt covers DK0491 DPI610E Bootloader

1563-notices-report-08_08_2022_16_01.txt covers DK0492 DPI610E Main Application.

2. Pump Operations

2.1 Pneumatic System

2.1.1 Use of Blanking Plug



A Blanking Plug seals the test port and stops foreign matter getting into the port. It is good practice to attach the Blanking Plug when the test port is not in use.

To attach the Blanking Plug to the test port: put the plug into the swivel connector and hold in position while turning the swivel connector fully counter-clockwise until it is hand tight.

To release the plug, hold the plug in position while turning the swivel connector clockwise until the plug can be removed.

2.1.2 Flexible hose

A flexible hose is delivered with the DPI 610E, to enable connection to other equipment. Two types of hose are available: one for Safe area use and the other for Intrinsically Safe (IS) environments.

Before use always visually check the hose for faults, such as splits or cuts in the hose.

Always make sure the instrument is safe to use.

2.1.3 Venting to atmosphere



A rapid drop in pressure can damage the instrument. Open the pressure release valve slowly and monitor the pressure reading until you reach the desired pressure.



To vent the system to atmospheric pressure, slowly turn the pressure release valve fully counter-clockwise until the sensor returns to zero (gauge sensor) or 1 bar (absolute sensor).

Chapter 2. Pump Operations

2.1.4 Attach Instrument Dirt (and Water) Trap to Test Port



INFORMATION It is recommended that a dirt trap is always used.



CAUTION To avoid damage to the dirt trap, hold it firmly while screwing it into the test port.

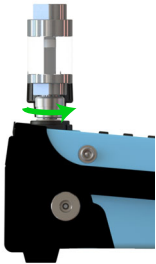

To attach the Instrument Dirt (and Water) Trap (IDT) to the test port, first remove the Blanking Plug if it is in the test socket: turn the swivel connector clockwise to release the plug. Put the trap into the socket while turning the swivel connector fully counter-clockwise until it is hand tight.

2.1.5 Attach/Remove Device Under Test

2.1.5.1 Attach Device Under Test



To avoid damage to the device under test, hold it firmly while screwing it into the test port/dirt trap.



To attach the device under test to the test port or dirt trap, put the trap into the thread of the swivel connector, then turn the swivel connector fully counter-clockwise until it is hand tight.

Note: Make sure that the device under test has a male G $\frac{3}{8}$ Quickfit adapter thread or use a suitable adapter rated to 35 bar.

If in doubt, please contact www.bakerhughesds.com/druck/global-service-support

2.1.5.2 Remove Device Under Test

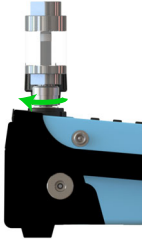

A rapid drop in pressure can damage the instrument. Open the pressure release valve slowly and monitor the pressure reading until you reach the desired pressure

<p>Step 1</p>		<p>Release all of the pressure in the instrument by opening the pressure release knob fully counter-clockwise.</p>
<p>Step 2</p>		<p>To remove the device under test, hold it firmly while turning the swivel connector it fully clockwise. Attach the Blanking Plug to seal and protect the socket if the instrument will not be in immediate use, see “Use of Blanking Plug” on page 27.</p>

Chapter 2. Pump Operations

2.1.6 Preparing the instrument for Pressure/Vacuum operation

Make sure the instrument is safe to use: refer to the instructions on page 27.

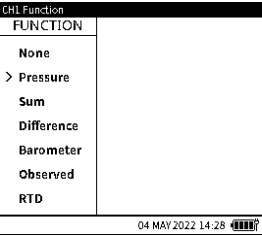
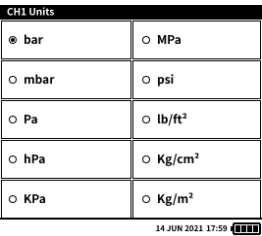
Step 1		<p>Power ON the instrument by holding down the power button for 2 seconds until the Druck splash screen appears.</p>
Step 2		<p>Select the required pressure function from the Channel Function screen. Note: From the dashboard select: CALIBRATOR >> CH1 or CH2 >> FUNCTION >> Pressure> INT>>Normal Select the Tick ✓ softkey and press the Back ↶ icon.</p>
Step 3		<p>Select the required units. Note: From the dashboard select: CALIBRATOR >> CH1 or CH2 >> UNITS >> either tap the unit required on the screen or use the Navigation key pad arrow keys to select the unit. Select the Tick ✓ softkey and press the Back ↶ icon.</p>



CAUTION To avoid damage to the device under test, hold it firmly while screwing it into the test port/dirt trap.

Step 4		<p>To attach the device under test to the test port or dirt trap: hold the device in the socket, then turn the swivel connector at the base of the connector fully counter-clockwise until it is hand tight. Note: Make sure that the device under test has a male G 3/8 Quickfit adapter thread or use a suitable adapter rated to 35 bar. If in doubt, please contact www.bakerhughesds.com/druck/global-service-support</p>
--------	---	---

2.1.7 Generating Pressure/Vacuum

<p>Step 1</p>		<p>Seal the system by turning the pressure release valve fully clockwise.</p>
---------------	---	---



CAUTION Do not submerge the instrument in the pressure medium. If fluid enters any part of the electrical connection panel, allow the instrument to dry out thoroughly before use.

<p>Step 2</p>		<p>Adjust the pressure-vacuum selector to pressure mode (+) or vacuum mode (-) depending on the desired operation. Note: To adjust the selector from pressure mode to vacuum mode, turn it clockwise. To adjust the selector from vacuum mode to pressure mode, turn it counter-clockwise.</p>
---------------	---	--

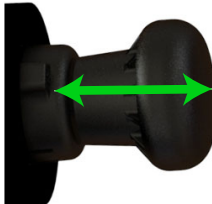

CAUTION To prevent the instrument from sliding, make sure that either the slip prevention feet are engaged or the instrument is secured against a flat surface.

<p>Step 3</p>		<p>Use the pump to achieve the desired pressure/vacuum.</p>
---------------	---	---

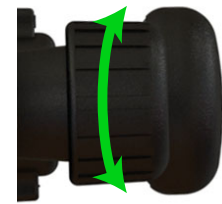
<p>Step 4</p>		<p>Turn the volume adjuster to make fine adjustments to the pressure/vacuum.</p>
---------------	---	--



A rapid change in pressure/vacuum can damage the instrument. Open the pressure release valve slowly and monitor the reading on the screen until you reach the desired pressure/vacuum.

Optional		To decrease pressure/vacuum, open and close the pressure release valve slowly.
----------	---	--

The above procedure is appropriate for general use, however, the procedure must be modified when low pressure (350 mbarg) or high vacuum (-950 mbarg) is required.

2.1.7.1 Creating Low Pressure (350 mbarg Full Scale)

Follow these instructions to achieve a low pressure:

1. Make sure that the device under test is properly connected to the test port and that the DPI 610E relief valve is fully open (turn counter-clockwise).
2. Make sure the pressure-vacuum selector is set to the '+' position for the pressure mode.
3. Turn the fine adjustment knob counter-clockwise until about 2 inches/5 cm of thread is exposed (from "fully in" position this should take around 15 full rotations).
4. Close the relief valve (turn clockwise) firmly to hand tight, to seal the system.
5. Make sure that the internal pressure is displayed on the unit display.
6. Push the pump slowly and gently and at the same time monitor the display for the increasing pressure. Stop pumping as soon as the required pressure is reached.

Note: The required pressure may be achieved with a less than one full pump stroke or it may require more depending on the device under test volume connected.

7. If the pressure is below the required value then go back to step 5.
8. If the pressure indicated is above the required pressure or if on the display shows >>>> (i.e. pressure is above the internal sensor full-scale limit) then use the fine adjustment knob by rotating counter-clockwise slowly to bring the pressure down to the required value.

2.1.7.2 Creating a High Vacuum (-950 mbarg)

Follow these instructions to achieve a high vacuum:

1. Turn the pressure/vacuum selector collar to the vacuum '-' position. Note that as the vacuum increases, it is only the last part of the pump travel (i.e. fully pulled-out) that actually increases the vacuum. This is exactly similar to pumping positive pressure, where it is only the last part of the inward travel that pushes air past the non-return valve as pressure rises. Therefore, for effective use, the pump must be fully pulled out (until the end stop is felt) to effectively generate vacuum.
2. It is much more effective to pull the pump knob out quite quickly (until end stop is hit) because this keeps the non-return valve fully open.
3. To try to get to -950 mbar is similar to trying to remove 95% of the air from the system: this requires approximately 15-20 (fast) strokes to achieve.
4. If difficulty is still encountered getting to low vacuum then stop pumping and use the volume adjuster – unscrewing this will draw further vacuum and reduce the pressure.
5. If -950 mbar is achieved but then the pressure slowly increases (i.e. system appears to be leaking) then check that the relief valve is tightly shut and the IDT (Instrument Dirt Trap) top/bottom seals are not leaking.

2.2 Hydraulic System

2.2.1 Filing the reservoir

Make sure the instrument is not pressurized: refer to Section 2.2.2 on page 35 for instructions. The instrument is supplied with a 100 cc (3 oz) reservoir tank. The pressure reservoir can be filled attached or detached from the instrument. When the reservoir is removed, seal the socket with the protective cap delivered with the instrument to prevent entry of foreign matter. Make sure that the pressure medium is compatible with your test device.

Note: The recommended pressure medium is demineralized water or mineral oil.

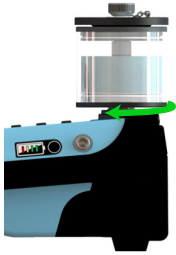
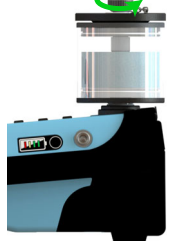

CAUTION Do not submerge the instrument in the pressure medium. If fluid enters any part of the electrical connection panel, allow the instrument to dry out thoroughly before use.

Step 1		Turn the reservoir into the reservoir port. Turn the reservoir clockwise, until it is hand tight.
Step 2		Turn the reservoir locknut counter-clockwise and remove the reservoir cover.



INFORMATION The pressure medium level must stay above the horizontal pin in the reservoir at all times when the instrument is in use. The volume of pressure medium in the reservoir shall not exceed 75cc when the instrument is in use. To avoid contamination, use only one type of pressure media in the instrument. If you wish to change the pressure medium after first use, please contact the Service Department.

The pressure medium level must always stay above the horizontal pin in the reservoir when the instrument is in use.

The volume of pressure medium in the reservoir must not exceed 75cc when the instrument is in use. The reservoir can be unscrewed from the instrument and filled. To avoid contamination, use only one type of pressure media in the instrument. If you wish to change the pressure medium after first use, please contact the Service Department.

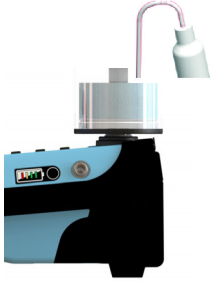
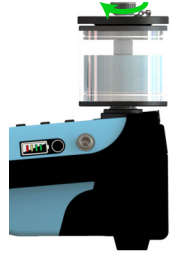
<p>Step 3</p>		<p>Use the squeeze bottle to fill the reservoir with pressure medium to approximately 75% capacity of the reservoir.</p>
<p>Step 4</p>		<p>Push the reservoir cover into position and turn the locknut clockwise until the reservoir cover just seals the reservoir, leaving a small amount of play, (finger tight and back off a quarter turn).</p>

2.2.2 Priming the Instrument









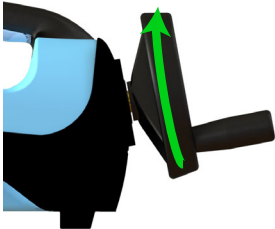



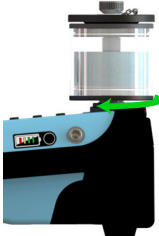

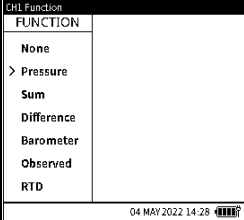
CAUTION Before operating the priming pump, always make sure that the test port is sealed beforehand. Priming the instrument when the test port is unsealed could cause the pressure medium to spray from the test port into the electrical ports.



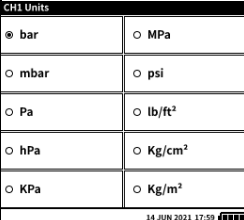



INFORMATION A blanking plug has been provided by the manufacturer and shipped with the instrument.

<p>Step 1</p>		<p>Make sure the test port is sealed by the Blanking Plug. To attach the Blanking Plug to the test port: put the plug into the thread of the swivel connector and hold in position while turning the swivel connector fully counter-clockwise until it is hand tight. Note: It is easier to bleed the system if a hose is attached after air has already been removed from the instrument. Go to step 16 for more information.</p>
<p>Step 2</p>		<p>Turn the volume adjuster wheel clockwise until it stops: this can be up to 30 turns. Note: This is the zero point.</p>

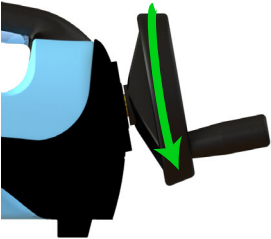
Chapter 2. Pump Operations

Step 3		<p>Make sure that the pressure release knob is at its fully closed position (hand tight): turn the knob in a clockwise direction.</p>
Step 4		<p>The reservoir must be connected the reservoir port and filled to the required level. See Section 2.2.1 on page 34.</p>
Step 5		<p>Power ON the instrument by holding down the power button for 2 seconds until the Druck splash screen appears.</p>
Step 6		<p>Select the required pressure function from the Channel Function screen. Note: From the Dashboard select: CALIBRATOR >>  ^{CH1} or  ^{CH2} >> FUNCTION >> Pressure> INT>>Normal</p> <p>Press the Tick  softkey and press the Back  icon to show the previous screen.</p>
Step 7		<p>Select the required units. Note: From the Dashboard select: CALIBRATOR >>  ^{CH1} or  ^{CH2} >> UNITS >> either tap the unit required on the screen or use the Navigation key pad arrow keys to select the unit.</p> <p>Press the Tick  softkey and press the Back  button to show the previous screen.</p>
Step 8		<p>Slowly operate the priming pump until the pressure reaches 5-10 bar.</p>

Step 9		<p>Turn the volume adjuster wheel fully counter-clockwise until it stops (this could need at least 29 turns). The indicated pressure reading will decrease.</p>
Step 10		<p>Slowly operate the priming pump until the pressure reaches 5-10 bar.</p>
Step 11		<p>Turn the pressure release knob a quarter of a turn counter-clockwise to release the pressure.</p>
Step 12		<p>Slowly operate the priming pump until no air bubbles come out of the hole in the reservoir center stem. Note: It should take 10-15 strokes to remove trapped air from the system.</p>



CAUTION Do not continue to operate the pump after air bubbles stop coming out of the central reservoir stem hole.



CAUTION Do not remove the blanking plug when the instrument is under pressure. Before removing the blanking plug, check the instrument pressure display for pressure. If pressure is observed, turn the pressure release knob fully counter-clockwise until the pressure display reads zero (gauge sensor) or atmospheric pressure (absolute sensor).

Step 13		<p>Remove the blanking plug from the test port.</p>
---------	---	---

Chapter 2. Pump Operations

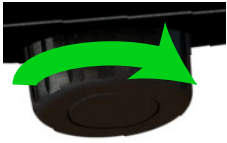
Step 14		Turn the pressure release knob fully clockwise, hand tight.
---------	---	---

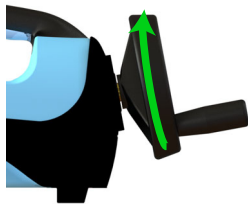

CAUTION Do not operate the priming pump. Only use the volume adjuster wheel.

Step 15		<p>Slowly turn the volume adjuster wheel 2-5 turns clockwise to remove any trapped air. [If mineral oil is used as the pressure media, operate the pump gently to avoid creating a mess.]</p> <p>Note: The user may notice air bubbles at the opening of the test port.</p>
Step 16	<p>The instructions in this Step 16 relate only to the connection of a hose to the test port and removal of air from this hose. If a test device is to be connected directly to the instrument (or to the hose after air has been removed), go to Step 17.</p> <p>Connect the hose to the test port and use the Step 10 to Step 15 procedures to remove air from the hose.</p> <p>Use Steps 10 and 11. Ignore Step 12. Use Steps 13 and 14.</p> <p>Step 15: Use the pump to move fluid into the hose. Stop using the pump when air bubbles do not appear at the hose outlet.</p>	

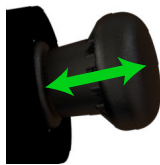

CAUTION Do not allow movement of hose to rotate adapter as this may cause internal damage to the instrument.

Step 17	<p>Hold the test device in position in the test socket while fully turning the swivel connector counter-clockwise until it is hand tight. A blanking plug can be attached to the hose end instead of a test device.</p> <p>Note: As required, use adapters provided with the instrument or an AMC adapter(s) and the corresponding seal(s).</p>	
Step 17		Use the priming pump to prime the system to a maximum of 10-20 bar.

2.2.3 Generating Pressure



INFORMATION Make sure the instrument is primed before attempting to generate pressure. Check the instrument pressure range on rear label before attempting to generate pressure.

Step 1		<p>After priming the instrument as described in Section 2.2.2, turn the volume adjuster wheel clockwise until the required pressure is achieved.</p> <p>Note: If the required pressure is not achieved or not stable, release the pressure in the instrument and repeat the priming sequence.</p>
--------	--	--

2.2.4 Releasing Pressure

Step 1		<p>To release pressure, open the pressure release knob by turning it counter-clockwise.</p>
--------	--	---

2.2.5 How to achieve 400 bar

For applications where pressures above 400 bar are required to be generated it is recommended that the system is primed to around 25 bar using the priming pump and that a hydraulic hose of no more than 1m length is used to connect to the device under test.

Note: Using long (or wide-bore) hoses may prevent the required pressure from being reached within the limits of the screw pump mechanism.

3. Basic Tasks

3.1 Tasks

Use the Dashboard to access the **Tasks** application. The **Tasks** menu has a list of tests that automatically configure the instrument when selected. The following options are available on the **Tasks** screen:

Step 1

Select the **Tasks** icon on the Dashboard to show a list of available tasks. Tap on the task to select it.

Note: Any **Task** option added to the Dashboard screen will be identified by a mini **Home** icon next to the option text. (As shown in the second screen).

Tasks	
> P - I	Leak Test
P - P	Switch Test
P - V	Tx Sim
I - P	Relief Valve
P-Display	

3.1.1 P-I (Pressure to Current measure)

This configures channel **CH1** to measure pressure, which can be internal (**INT**) or external (**EXT**). If external pressure is detected on **CH1**, it will retain this function, otherwise it defaults to internal pressure.

Channel **CH2** is configured to measure Current.

This task is typically for calibrating Current Output Pressure transmitters.

3.1.2 P-P (Pressure to Pressure)

This configures **CH1** to internal (**INT**) pressure measurement and **CH2** to external (**EXT**) pressure measurement.

3.1.3 P-V (Pressure to Voltage)

This configures **CH1** to measure pressure, which can be internal (**INT**) or external (**EXT**). If external pressure is detected on **CH1**, it will retain this function otherwise, it defaults to internal pressure.

CH2 is configured to measure Voltage.

This task is typically for calibrating Voltage Output Pressure transmitters.

3.1.4 I-P (Pressure to Current source)

This configures **CH1** to measure pressure, which can be internal (**INT**) or external (**EXT**). If external pressure is detected on **CH1**, it will retain this function otherwise, it defaults to internal pressure.

CH2 is configured to Current source.

This task is typically used for calibrating I/P pressure converters.

3.1.5 P-Display (Pressure to Display)

This configures **CH1** to measure pressure which can be internal (**INT**) or external (**EXT**). If external pressure is detected on **CH1**, it will retain this function otherwise, it defaults to internal pressure.

CH2 is configured to Observed function.

This task is typically used for calibrating pressure devices with no electrical output but which have a visual indication of measured pressure.

3.1.6 Leak Test

This configures **CH1** to pressure measure which can be internal (**INT**) or external (**EXT**) with the **Leak Test** utility. If external pressure is detected on **CH1**, then the external pressure configuration is kept, otherwise **CH1** defaults to internal pressure configuration.

CH2 configuration remains unchanged.

For more details on the **Leak Test**, refer to Section 7.1 on page 129.

3.1.7 Switch Test

This configures **CH1** to measure pressure, which can be internal (**INT**) or external (**EXT**) while the **Switch Test** utility details are displayed on **CH2**. If external pressure is detected on **CH1**, it keeps this function, otherwise it defaults to internal pressure.

For more details on the **Switch Test**, refer to Section 7.2 on page 134.

3.1.8 TX SIM (Transmitter Simulation)

This configures **CH1** to measure pressure, which can be internal (**INT**) or external (**EXT**). If external pressure is detected on **CH1**, it will retain this function otherwise, it defaults to internal pressure.

CH2 is configured with Current source (in transmitter simulation mode).

For more details on the **TX SIM** task, refer to Section 7.3 on page 137.

3.1.9 Relief Valve Test

This configures **CH1** to measure pressure, which can be internal (**INT**) or external (**EXT**) with the **Relief Valve Test** utility. If external pressure is detected on **CH1**, it will retain this function otherwise, it defaults to internal pressure.



CH2 configuration remains unchanged.

For more details on the **Relief Valve Test**, refer to Section 7.4 on page 139.

3.2 Tasks Selection



To select any of the options on the **Tasks** menu for automatic configuration, first tap the desired option to select it, then tap again to initiate the configuration of the selected task. This is effectively a two-tap action that can be done in quick succession. If using the navigation buttons, use the UP/DOWN/LEFT/RIGHT buttons to select the desired task and press the Navigation Pad **OK**  Enter button to initiate configuration of the selected task.

3.3 Adding Tasks to the Dashboard

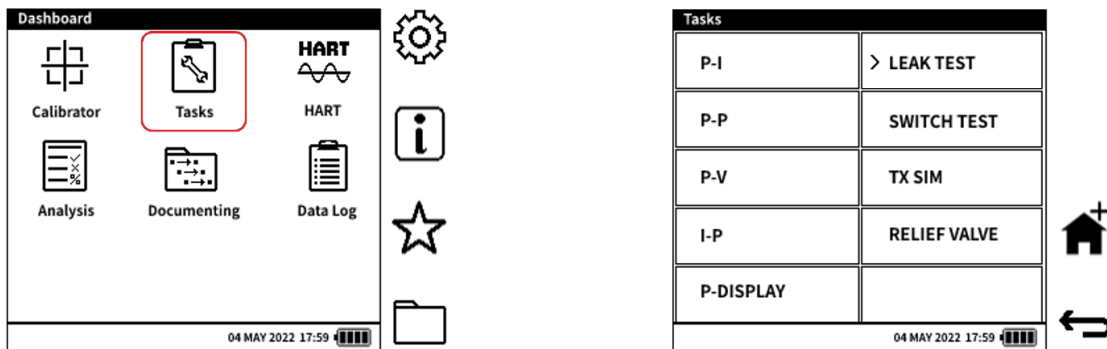
Up to three commonly used tasks from the Tasks menu can be added to the Dashboard (Home) screen as a shortcut. To add a **Task** option to the Dashboard, tap to select the desired Task, then select the **(HOME+)**  softkey to add the selected option to the Dashboard. If using the navigation buttons, use the UP/DOWN/LEFT/RIGHT buttons to select the desired task and press the **(HOME+)**  icon to add the selected option to the Dashboard. Any **Task** option added to the Dashboard screen will be identified by a mini Home  icon next to the option text.



3.4 Removing Tasks from the Dashboard

Only Tasks added through the **Tasks** menu can be removed from the Dashboard. To remove a Task option from the Dashboard: from the **Tasks** menu tap to select the desired Task, then select the **(HOMEEx)**  icon to remove the selected option. If using the navigation buttons, use the UP/DOWN/LEFT/RIGHT buttons to select the desired task and press the **(HOMEEx)**  softkey to remove the selected option. Once removed, the mini **HOME**  icon next to the option text will disappear.

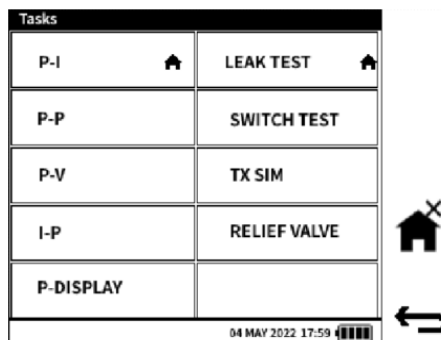



4. General Settings

The following **General Settings** are available on the DPI 610E:

Setting	Description
DATE/TIME	Set the date/time.
LANGUAGE	Set the language.
BACKLIGHT	Turn the back light on/off.
USB	Select the USB communication mode.
AUTO POWER DOWN	Enable/disable Auto Power Down.
TOUCHSCREEN LOCK	Enable/disable Touchscreen Lock.
ENABLE HOLD	Enable/disable Hold.
ADVANCED	Access the Advanced Menu.

Note: To access the **General Settings** menu from the Dashboard, tap the  icon on the touchscreen or press the corresponding softkey as shown below:

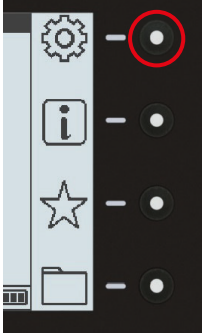
Option 1		Tap the  icon on the touchscreen.
Option 2		Press the softkey corresponding to the General Settings icon.

4.1 DATE, TIME and LANGUAGE

To change the Date, Time and Language settings, see “Set Date, Time and Language” on page 25.



4.2 BACKLIGHT

This feature controls the instrument backlight. By default, the DPI 610E is configured to **Timed (5 Minutes)**.

To change this setting:

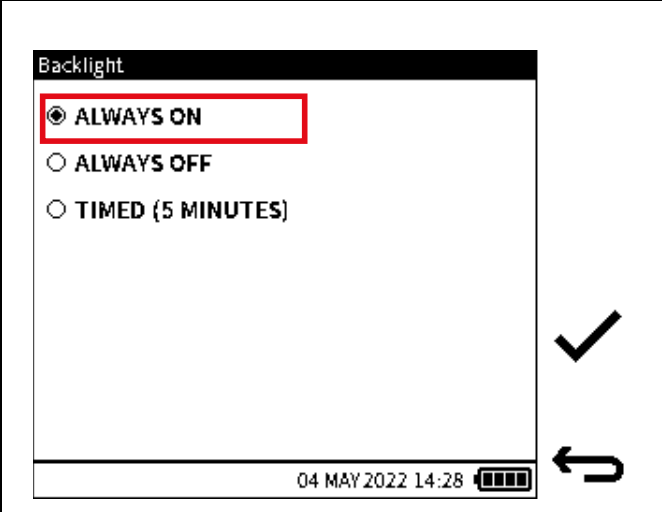
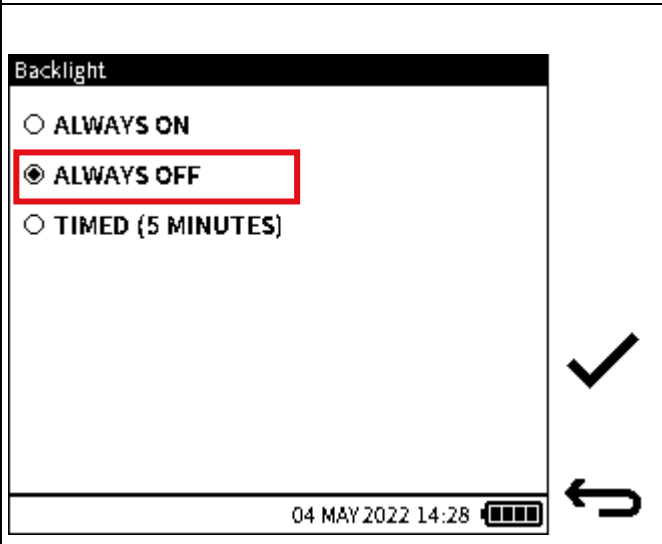
1. Select **Backlight** from the **General Settings** menu.
2. Select the required mode (described below).
3. Select  to confirm.

	<p>If ALWAYS ON is selected, the backlight will remain on when the instrument is on, except when the battery is at a critically low level.</p>
	<p>If ALWAYS OFF is selected, the backlight will remain off at all times when the instrument is on.</p>

 <p>Backlight</p> <ul style="list-style-type: none"> <input type="radio"/> ALWAYS ON <input type="radio"/> ALWAYS OFF <input checked="" type="radio"/> TIMED (5 MINUTES) <p>04 MAY 2022 14:28 </p>	<p>If TIMED (5 MINUTES) is selected, the backlight will remain on and automatically switch off after a period of 5 minutes of inactivity.</p>
--	--



4.3 USB

The following USB settings are available on the DPI 610E:

Setting	Description
Mass Storage	Storage mode facilitating the transfer of files/folders between the instrument and a PC.
Virtual Comms Port (VCP)	Communications mode.

Note: **Mass Storage** mode is the default USB setting at each power on.

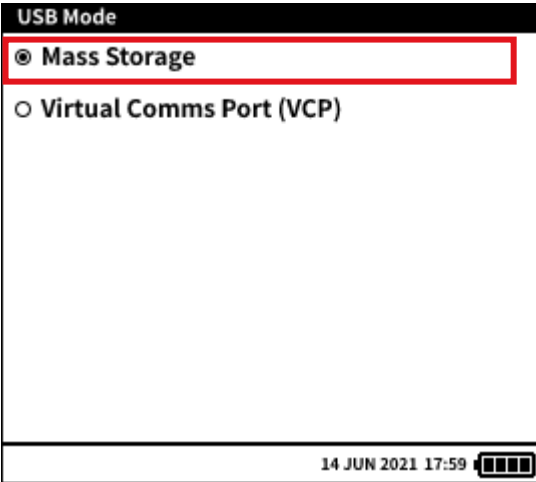
To change this setting during use:

<p>Step 1</p>	 <p>USB Mode</p> <ul style="list-style-type: none"> <input checked="" type="radio"/> Mass Storage <input type="radio"/> Virtual Comms Port (VCP) <p>14 JUN 2021 17:59 </p>	<p>Select Virtual Comms Port (VCP).</p>
---------------	---	--

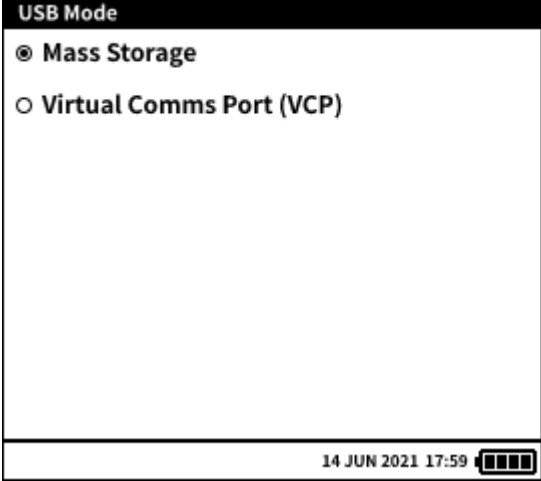
Step 2		Select ✓ to confirm.
--------	---	----------------------



4.4 AUTO POWER DOWN

This feature controls the auto power down behavior of the instrument. By default, the DPI 610E is configured to remain on until powered down by the user.

To change this setting:

1. Select **Auto Power Down**.
2. Select the required mode (described below).
3. Select ✓ to confirm.

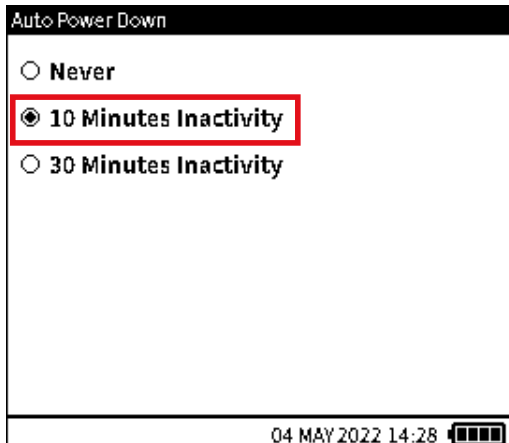
	If Never is selected, the instrument will remain on until powered down by the user.
---	--

 <p>Auto Power Down</p> <ul style="list-style-type: none"><input type="radio"/> Never<input checked="" type="radio"/> 10 Minutes Inactivity<input type="radio"/> 30 Minutes Inactivity <p>04 MAY 2022 14:28 [Battery Icon]</p>	<p>If 10 Minutes Inactivity is selected, the instrument will automatically switch off after 10 minutes of inactivity.</p> <p>Note: Auto Power Down will not come into effect until all tests running have been completed.</p>
 <p>Auto Power Down</p> <ul style="list-style-type: none"><input type="radio"/> Never<input type="radio"/> 10 Minutes Inactivity<input checked="" type="radio"/> 30 Minutes Inactivity <p>04 MAY 2022 14:28 [Battery Icon]</p>	<p>If 30 Minutes Inactivity is selected, the instrument will automatically switch off after 30 minutes of inactivity.</p> <p>Note: Auto Power Down will not come into effect until all tests running have been completed.</p>

Chapter 4. General Settings

4.5 TOUCHSCREEN LOCK

This feature allows the user to lock the touchscreen and navigate using the navigation keypad and softkeys only. By default, the DPI 610E is configured with **Touchscreen Lock** disabled.

To change this setting:

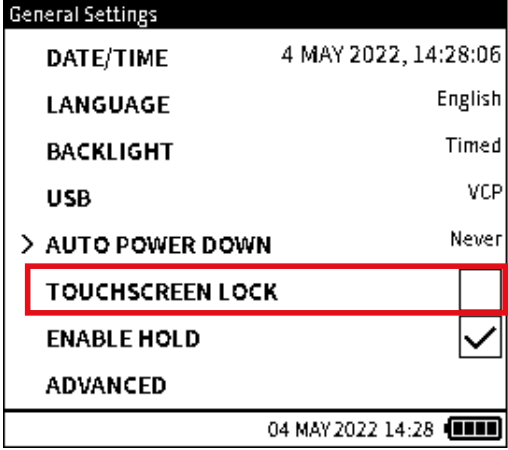
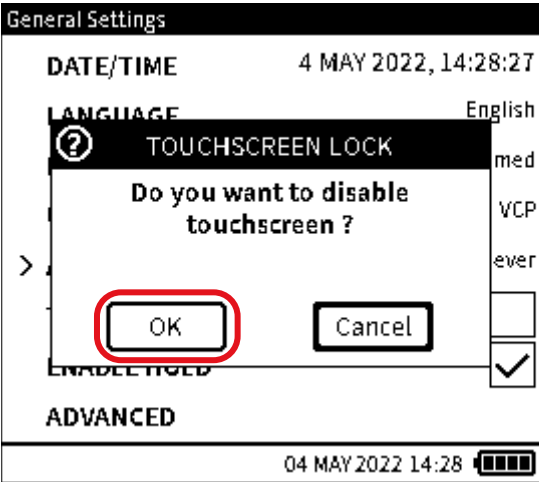
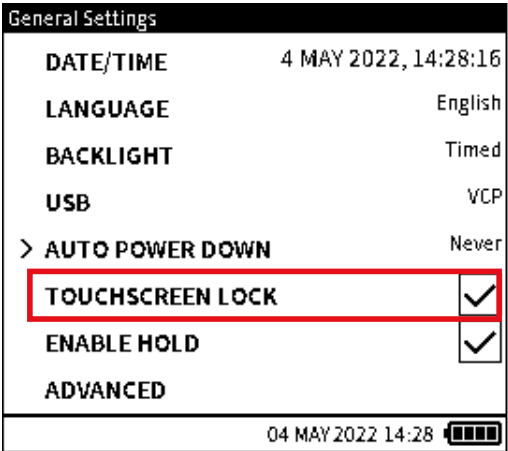
Step 1		Check TOUCHSCREEN LOCK box is unchecked (it has no Tick mark).
Step 2		Select OK .
Step 3		Ensure that TOUCHSCREEN LOCK is checked. Note: TOUCHSCREEN LOCK can be disabled by tapping anywhere on the touchscreen 3 times within 5 seconds.

4.6 ENABLE HOLD

This feature allows the user to enable/disable the  icon (Hold) on the main reading screen. By default the DPI 610E is configured with **Enable Hold** enabled.

To change this setting:

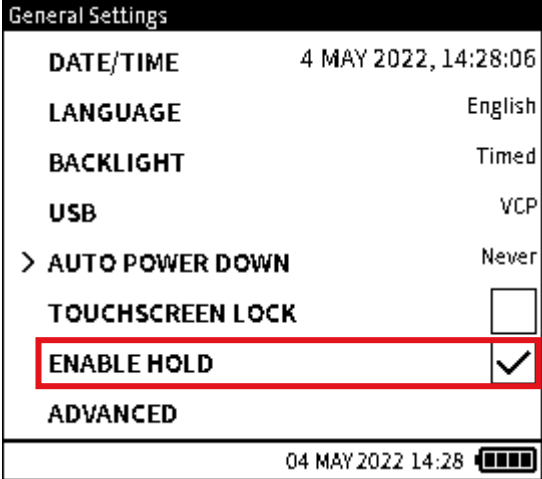
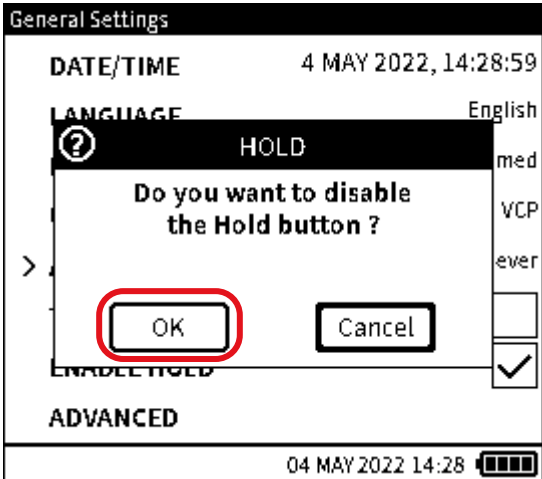
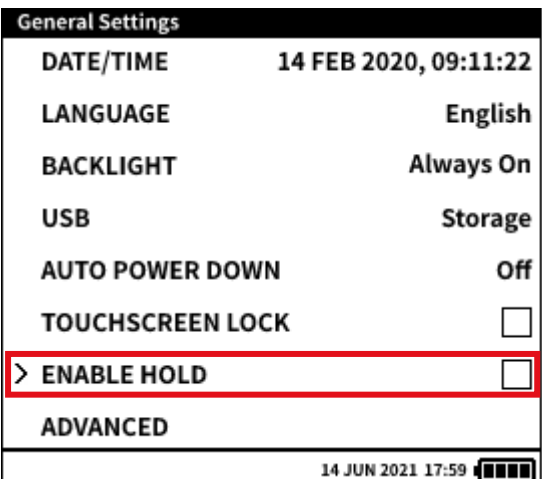
Step 1		Uncheck ENABLE HOLD .
Step 2		Select OK .
Step 3		Ensure that ENABLE HOLD is unchecked.

Chapter 4. General Settings

4.7 ADVANCED

This feature provides access to the **Advanced Menu**, which has the following options:

Option	Description
CALIBRATION*	Calibration options.
CHANGE PIN	Change the Advanced menu PIN.
SOFTWARE UPGRADE	Upgrade system software.
FACTORY RESET	Set the instrument back to default settings
FORMAT FILE SYSTEM	Erases all content on mass storage and creates factory default folders
SERVICE/ ENGINEERING	Reserved for internal use

*The Calibration options are dealt with by Chapter 13 on page 226 and the other options in Chapter 5 on page 52 forwards.

To access the **Advanced Menu**:

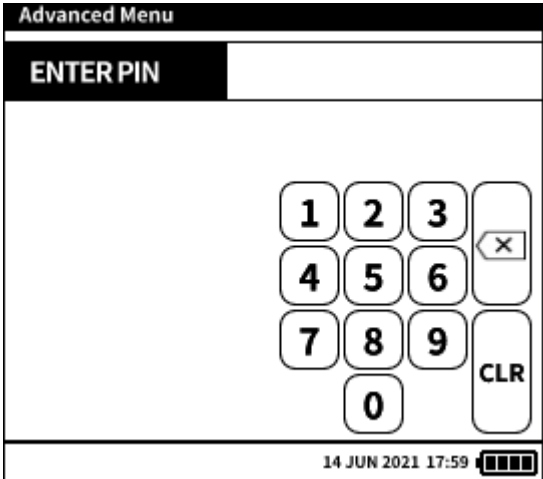
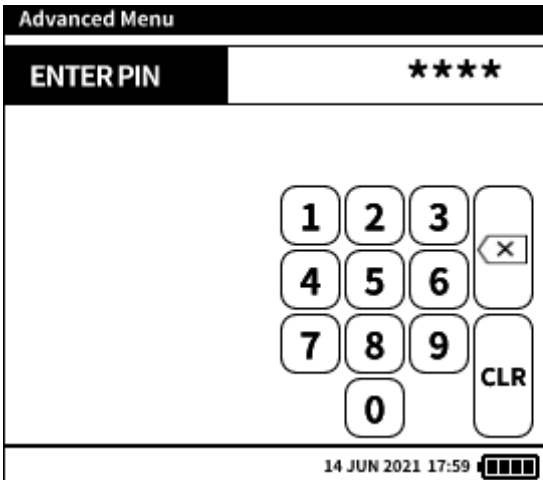
Step 1		Enter the PIN. The default PIN is 4321 and it can be changed by the user at any time. See Section 5.2 on page 54.
Step 2		Select ✓ to confirm.

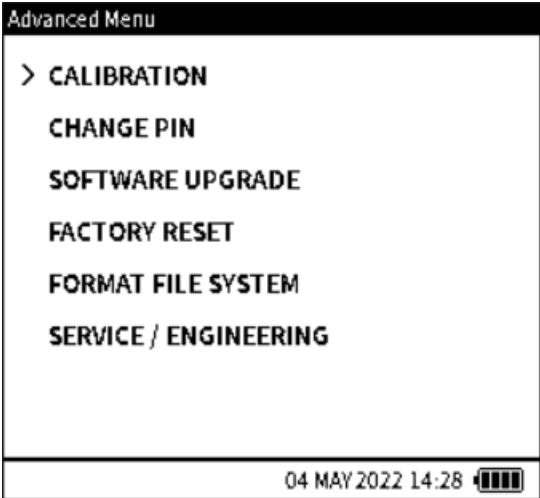
<p>Step 3</p>		<p>The Advanced Menu screen is now unlocked and its options available (see “Advanced Menu” on page 52)</p>
---------------	---	---

5. Advanced Menu

The following options are available in the **Advanced** menu:

Option	Description
*CALIBRATION	Calibration options
CHANGE PIN	Change the PIN
SOFTWARE UPGRADE	Start software upgrade
FACTORY RESET	Set the instrument back to default settings
FORMAT FILE SYSTEM	Erases all content on mass storage and creates factory default folders
SERVICE / ENGINEERING	Reserved for internal use

Note: To access the Advanced menu, select **ADVANCED** from the **General Settings** menu (see Chapter 4.7, “ADVANCED,” on page 50).

* A separate chapter describes the Instrument Calibration options. (See Chapter 13 on page 226).

5.1 CALIBRATION Menu

The **INSTRUMENT** option is available in the **Calibration** screen (Figure 5-1):

Option	Description
INSTRUMENT	Perform calibration activities on the instrument

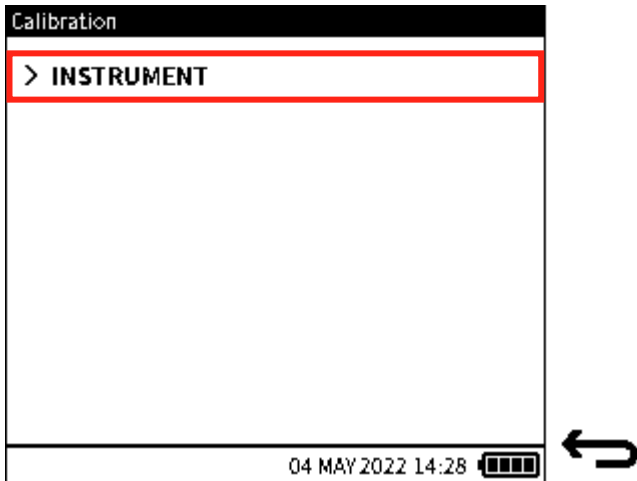

Figure 5-1: Calibration Menu

Note: To access the **CALIBRATION** menu (Figure 5-1), select **CALIBRATION** from the **Advanced Menu** screen as shown below:

Step 1		Select CALIBRATION from the Advanced Menu .
--------	--	---

Refer to Chapter 13, “Instrument Calibration” on page 226, for how to use the CALIBRATION menu and its options.

5.2 CHANGE PIN

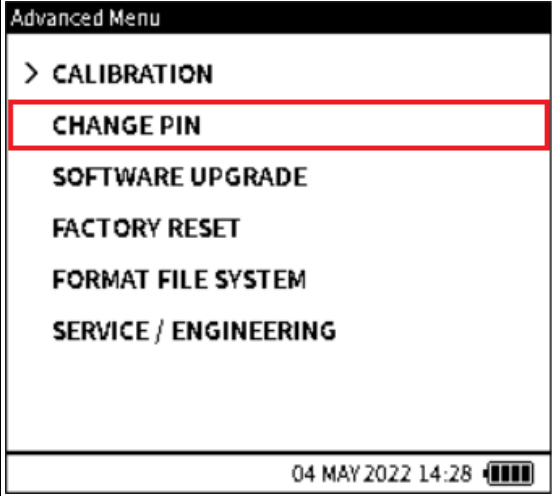
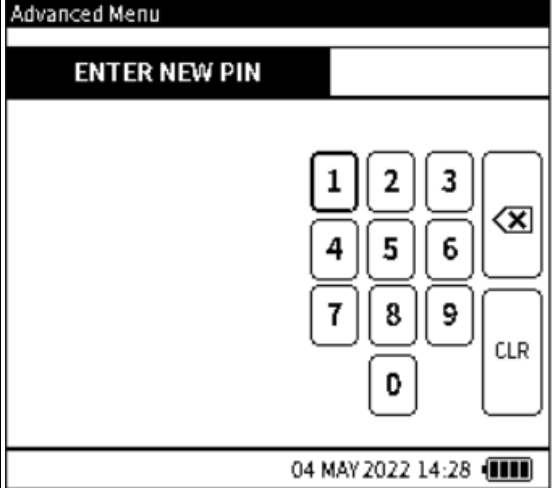

This option allows the user to change the instrument PIN number.

Step 1		Select CHANGE PIN from the Advanced menu.
Step 2		To change the PIN to a new number, use the onscreen keypad to enter the new number. Select ✓. Enter the new PIN again and select ✓ to confirm the selection.

5.3 SOFTWARE UPGRADE

This option allows the user to upgrade the firmware software of the instrument. Before this can be done, a software upgrade file must first be transferred into the instrument.

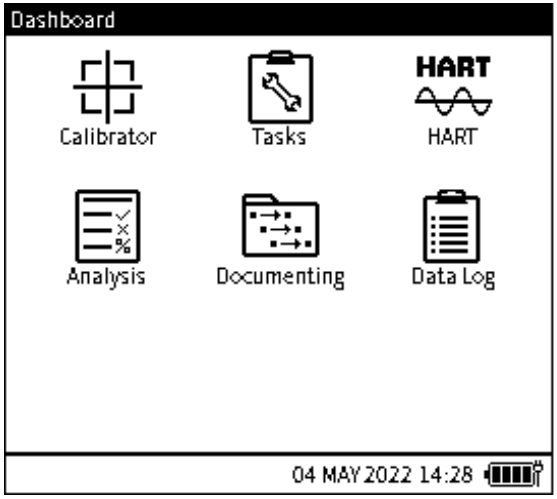
5.3.1 How to load a Software Upgrade File

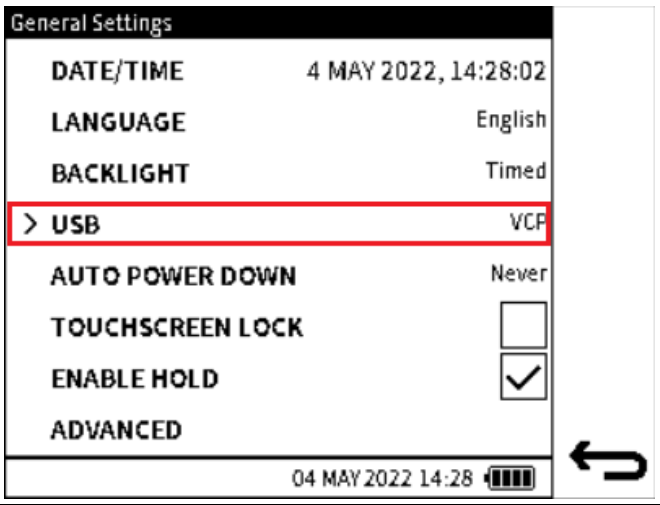
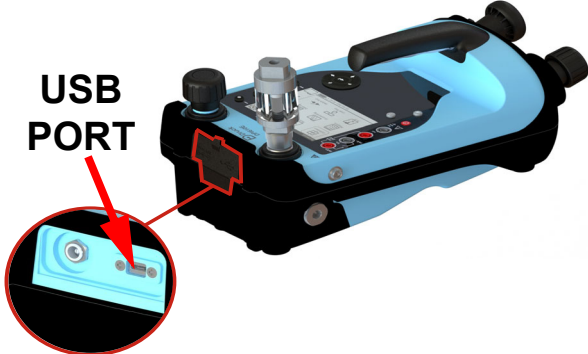
<p>Step 1</p>	<p>Download the “DK0492.raw” application image from https://inspectionworks.com/druck-portal/#/store/public on to the PC that is to connect to the DPI 610E. Make sure the file name is not renamed.</p>	
<p>Step 2</p>		<p>Select the Settings icon  on the Dashboard. Press the Home button  if necessary, to show the Dashboard. To select, tap on the icon or press the softkey on the right of icon.</p>
<p>Step 3</p>		<p>The General Settings screen appears. Select the USB option.</p>  <p>USB PORT</p>

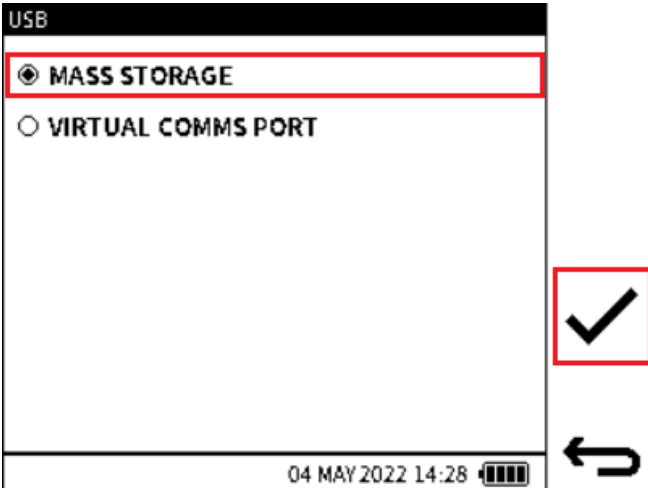
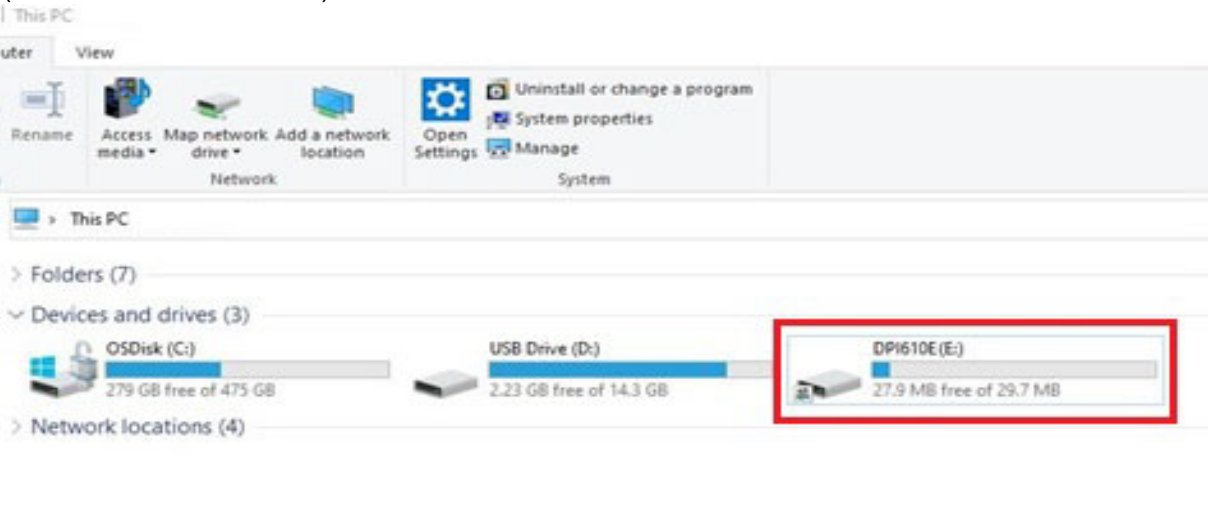
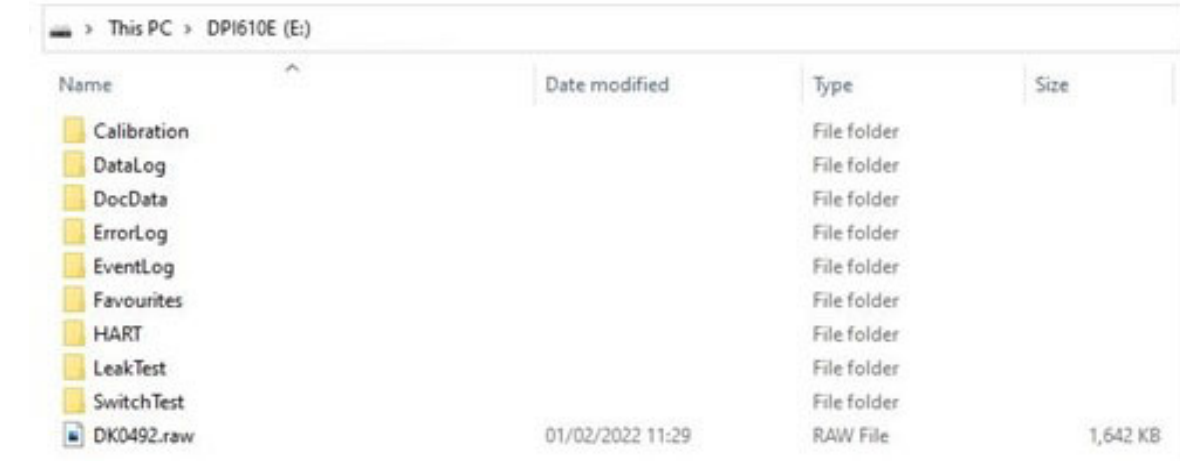

Chapter 5. Advanced Menu

<p>Step 4</p>		<p>Click on MASS STORAGE to select the option.</p> <p>Select ✓ to confirm the selection.</p>																																												
<p>Step 5</p>	<p>Connect the DPI 610E to the PC using a micro-USB data cable.</p> <p>Note: You may have to request for USB exception via Service Catalog: http://servicecatalog.ent.bhicorp.com/usm/wpf?Node=icguinode.catalogitemdetails&Args=11846&ObjectID=11846&NspPath=&searchIn=&searchInstr=Entire%20Catalog</p> <p>The PC should automatically detect the DPI 610E which should appear as a Mass Storage drive (default name is DPI610E).</p> 																																													
<p>Step 6</p>	<p>Copy the DK0492.raw file from the PC file system location and paste it into the root directory of the DPI 610E mass storage drive. .</p>  <table border="1" data-bbox="263 1579 1396 1982"> <thead> <tr> <th>Name</th> <th>Date modified</th> <th>Type</th> <th>Size</th> </tr> </thead> <tbody> <tr><td>Calibration</td><td></td><td>File folder</td><td></td></tr> <tr><td>DataLog</td><td></td><td>File folder</td><td></td></tr> <tr><td>DocData</td><td></td><td>File folder</td><td></td></tr> <tr><td>ErrorLog</td><td></td><td>File folder</td><td></td></tr> <tr><td>EventLog</td><td></td><td>File folder</td><td></td></tr> <tr><td>Favourites</td><td></td><td>File folder</td><td></td></tr> <tr><td>HART</td><td></td><td>File folder</td><td></td></tr> <tr><td>LeakTest</td><td></td><td>File folder</td><td></td></tr> <tr><td>SwitchTest</td><td></td><td>File folder</td><td></td></tr> <tr><td>DK0492.raw</td><td>01/02/2022 11:29</td><td>RAW File</td><td>1,642 KB</td></tr> </tbody> </table> <p>If a previously existing DK0492.raw file is present, a popup window will indicate this. Select Overwrite to replace the old file.</p>		Name	Date modified	Type	Size	Calibration		File folder		DataLog		File folder		DocData		File folder		ErrorLog		File folder		EventLog		File folder		Favourites		File folder		HART		File folder		LeakTest		File folder		SwitchTest		File folder		DK0492.raw	01/02/2022 11:29	RAW File	1,642 KB
Name	Date modified	Type	Size																																											
Calibration		File folder																																												
DataLog		File folder																																												
DocData		File folder																																												
ErrorLog		File folder																																												
EventLog		File folder																																												
Favourites		File folder																																												
HART		File folder																																												
LeakTest		File folder																																												
SwitchTest		File folder																																												
DK0492.raw	01/02/2022 11:29	RAW File	1,642 KB																																											



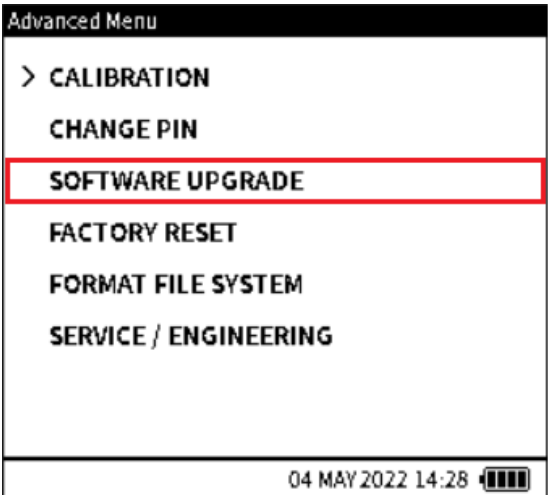

Step 7	When the successful transfer of the DK0492.raw file from the PC to the memory of the DPI 610E is confirmed, remove the USB cable from the DPI 610E. The next heading describes the procedure for how to upgrade the software firmware.
--------	--

5.3.2 How to upgrade the Firmware

Use the following procedure to upgrade the firmware (software embedded in hardware):

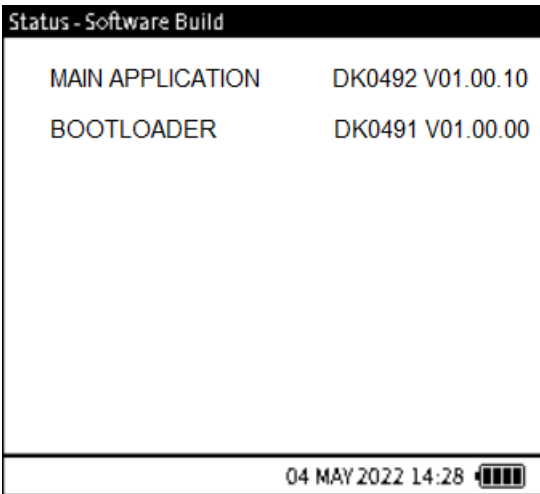
Step 1		<p>Select SOFTWARE UPGRADE from the Advanced Menu screen. Refer to Section 5.3.1 on page 55 for how to show this screen.</p>
Step 2		<p>The upgrade process will start when the OK button is pressed. Be aware that this will reboot the DPI 610E.</p>

Chapter 5. Advanced Menu

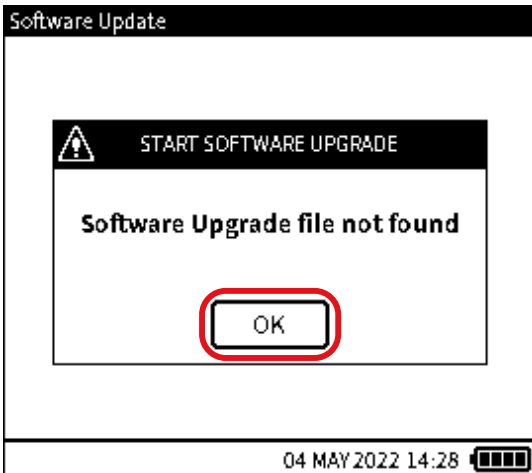
<p>Step 3</p>	 	<p>The DPI 610E starts again and shows the Dashboard screen.</p> <p>Press the Information (Status)  icon then select SOFTWARE BUILD on the Status screen that appears.</p> <p>The versions of the DK0491 Boot-loader and DK0492 Application software will be shown. Check that these are correct.</p> <p>The  icon shows a QR image that can be scanned using a mobile phone. This will take you to a website that describes how to upgrade your application.</p> <p>Select  to return to the Status screen.</p>
<p>Step 4</p>		<p>If the 'Software Upgrade file not found' notification appears. Make sure that the upgrade file "DK0492.raw" has been copied into the instrument's root directory, as stated in the previous steps.</p> <p>Select the OK button to close this screen message.</p> <p>Contact the Service Dept using the links given in Chapter 1 of this manual if you are unable to upgrade the software.</p>

5.4 FACTORY RESET

This option allows the user to reset the instrument to factory settings. All previous user files will be removed by this operation.

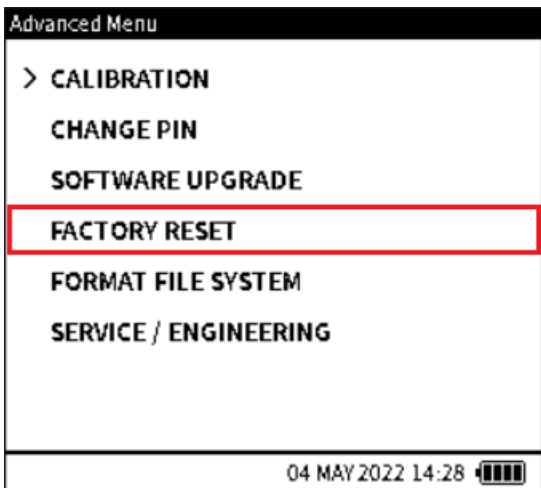
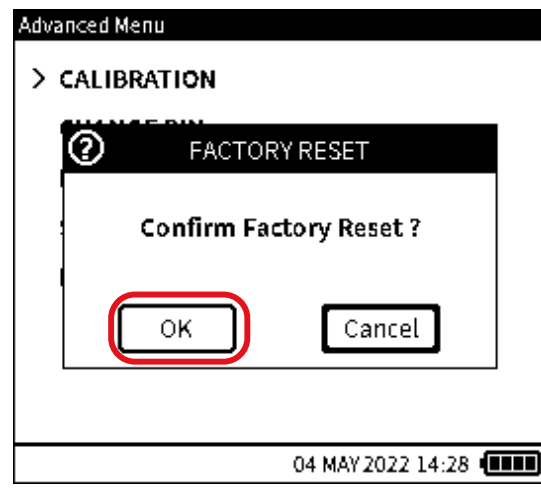
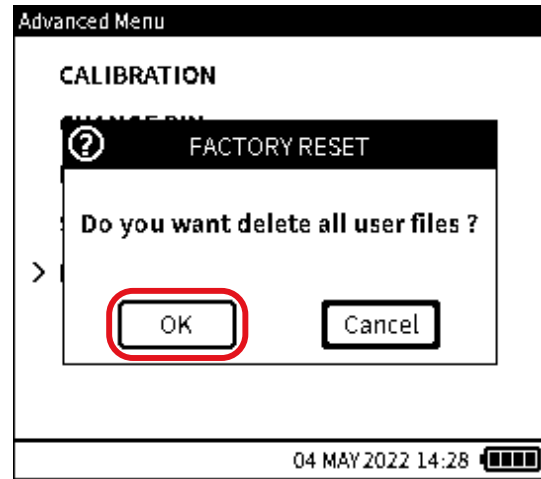
<p>Step 1</p>		<p>Select FACTORY RESET from the Advanced Menu screen.</p>
<p>Step 2</p>		<p>Select OK button to confirm selection of Factory Reset.</p>
<p>Step 3</p>		<p>Select OK button to confirm deletion of all user files.</p>

Chapter 5. Advanced Menu

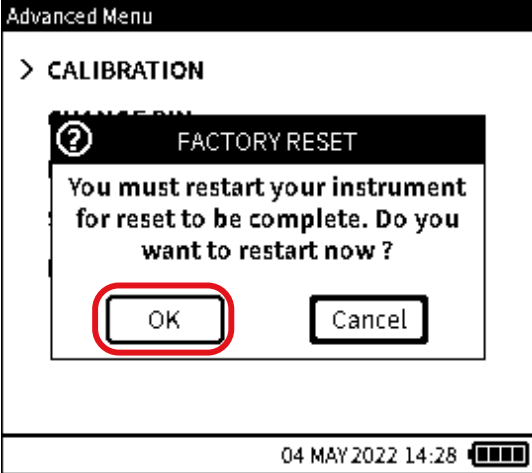
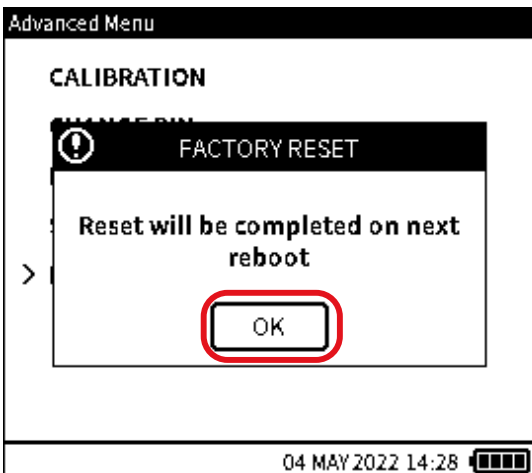
Step 4	 A screenshot of the 'Advanced Menu' interface. At the top, it says 'Advanced Menu' and '> CALIBRATION'. Below that is a dialog box titled 'FACTORY RESET' with a question mark icon. The text inside the dialog box reads: 'You must restart your instrument for reset to be complete. Do you want to restart now?'. There are two buttons: 'OK' and 'Cancel'. The 'OK' button is circled in red. At the bottom of the screen, it shows the date and time '04 MAY 2022 14:28' and a battery level indicator. A curved arrow points from the right side of the dialog box towards the right column.	Select OK button to confirm restart of instrument.
Option	 A screenshot of the 'Advanced Menu' interface. At the top, it says 'Advanced Menu' and 'CALIBRATION'. Below that is a dialog box titled 'FACTORY RESET' with a warning icon. The text inside the dialog box reads: 'Reset will be completed on next reboot'. There is one button: 'OK', which is circled in red. At the bottom of the screen, it shows the date and time '04 MAY 2022 14:28' and a battery level indicator. A curved arrow points from the right side of the dialog box towards the right column.	If Cancel is selected in Step 4, reset will be completed on next boot. Select OK button to confirm selection.

5.5 FORMAT FILE SYSTEM

The file system can be formatted if the instrument is out of storage space and a one-step clear out is desired. It is important to save any important files as well as the files available in the HART folder before formatting.

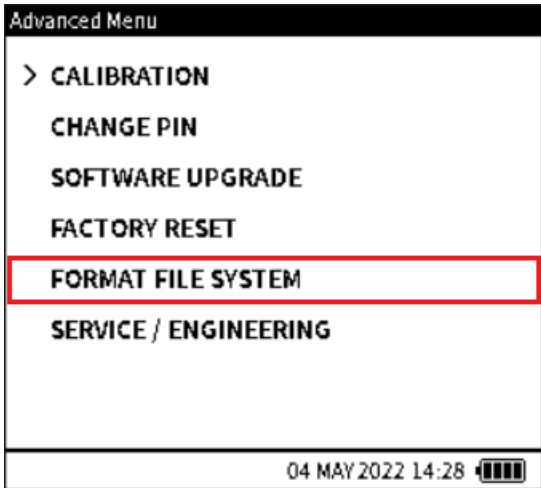
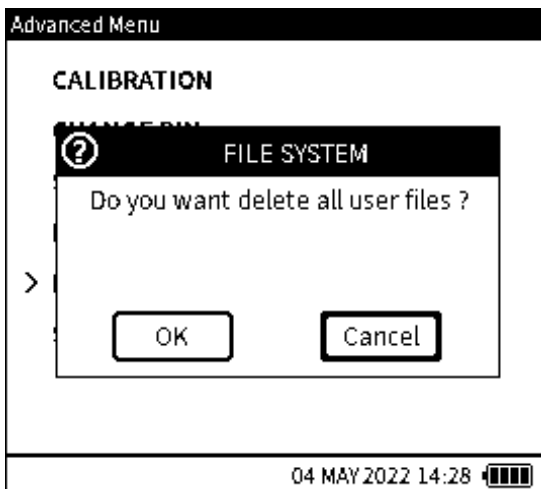
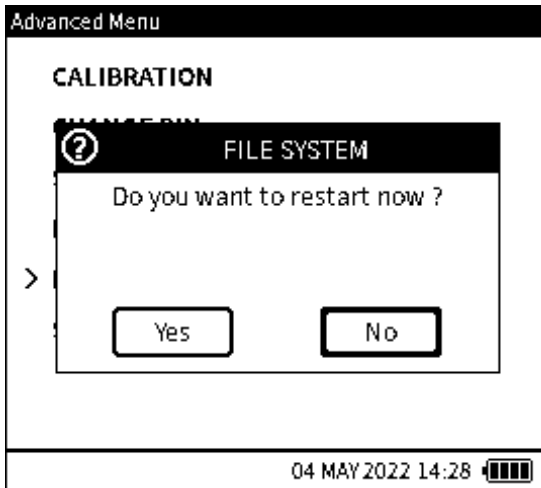
<p>Step 1</p>		<p>Select FORMAT FILE SYSTEM from the Advanced Menu screen.</p>
<p>Step 2</p>		<p>A popup window appears. All user files must be deleted, to enable formatting of the file system operation to occur. Press the OK button to proceed.</p>
<p>Step 3</p>		<p>To restart the instrument and complete the format operation, select Yes in the popup message window. If No is selected, a popup message appears "Formatting will be completed on next reboot". Click OK to close this message window. After the instrument is restarted, copy any backup files back into their respective folders.</p>

5.6 SERVICE / ENGINEERING

This Advanced **SERVICE/ENGINEERING** function is not for operator use and requires a PIN for use only by specialist users.

6. Calibrator Tasks

6.1 Calibrator Task Screen

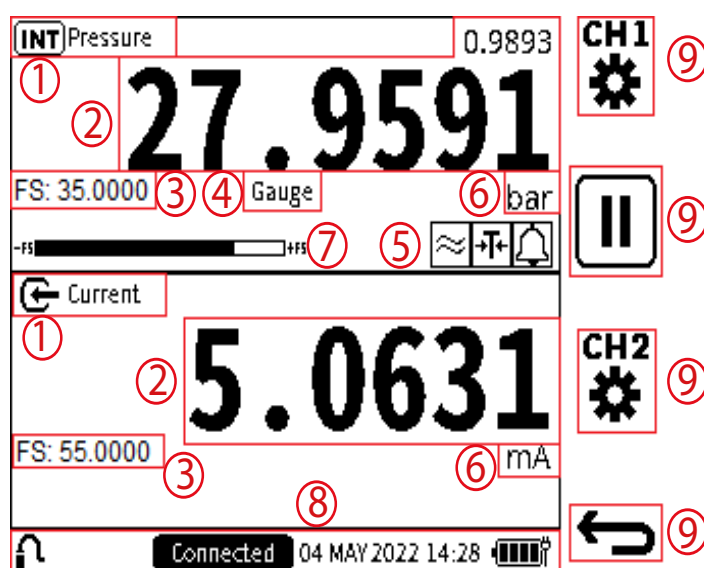

Figure 6-1: Calibrator Task Screen

1. **Function Name** – name of the currently selected function on the channel.
2. **Primary reading** – measured values that directly represent the channel function description and displayed in large digits within the channel windows. A secondary reading can appear in the either channel window. This reading is in smaller digits just above the primary reading: this shows the measured values associated with the primary reading of the channel function.
3. **Full-scale value** – each function selected has a maximum measurement capability which is captured by the positive full-scale value. It is always displayed in the channel window (with a prefix **FS:**).
4. **Sensor Type** – this applies to pressure or temperature sensors. The pressure sensor type (Gauge, Sealed Gauge or Absolute) or RTD sensor being used by the channel function will be displayed in this field.
5. **Process Options** – Any process options that are currently active for each channel is indicated by process icons in this area of the channel window.
6. **Units** – measurement units of the primary (and secondary reading where applicable) are displayed in the units field on the right hand side of the channel window below the primary reading.
7. **Full Scale Bar** – this bar gives a visual indication of the proportion of generated and measured pressure from the internal sensor of the full-scale range.
8. **Status bar** – the status bar area is present throughout the user interface and provides date and time information, battery level indication on the bottom right hand side of the screen. On the left side of the status bar, additional information about remote or external sensor connection status is provided. Critical information such as calibration overdue or alarm condition is also displayed within the status bar.
9. **Softkey** – up to four softkeys are available throughout the menu screens giving touchscreen and button options for operating different aspects of the user interface.

Chapter 6. Calibrator Tasks

6.1.1 Calibrator Tasks Screen Shortcuts

6.1.1.1 Maximize and Minimize Channel Window

Using the Touchscreen

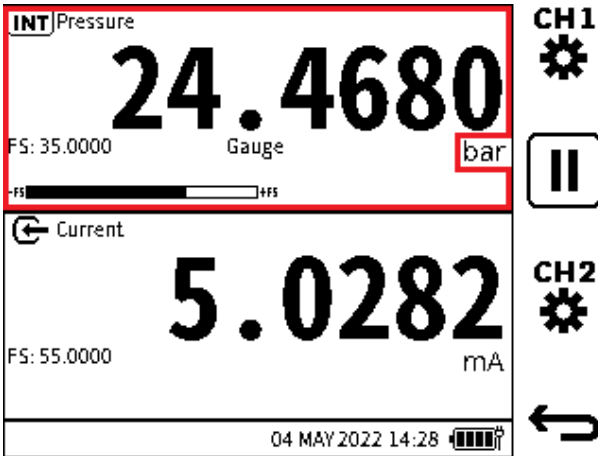
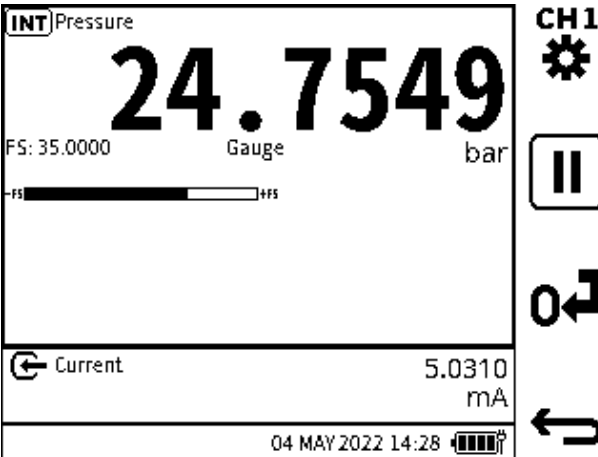
Step 1		CH1 ⚙️ ⏸️	When in the default 50:50 channel window layout, tap on any blank area on the desired channel window (except the Units area) to maximize the window area. This will minimize the other channel window.
		CH1 ⚙️ ⏸️ ↶ ↷	



INFORMATION When in maximized/minimized layout, the 50:50 layout can be restored by tapping on any area of the channel windows with the exception of the Units area.

Using Navigation Buttons

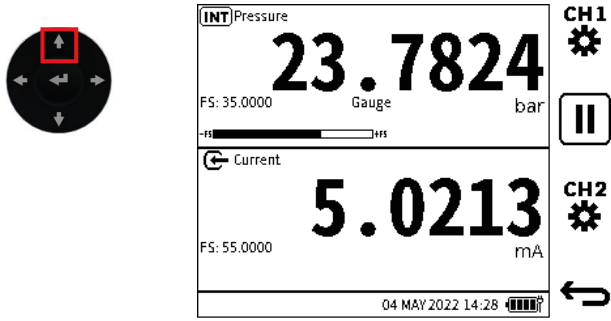
<p>Step 1</p>		<p>When in the default 50:50 channel window layout, press the UP button to select the Channel 1 (CH1) window area.</p>
---------------	---	---

i **INFORMATION** Press the **DOWN** button to select the Channel 2 (CH2) window area.

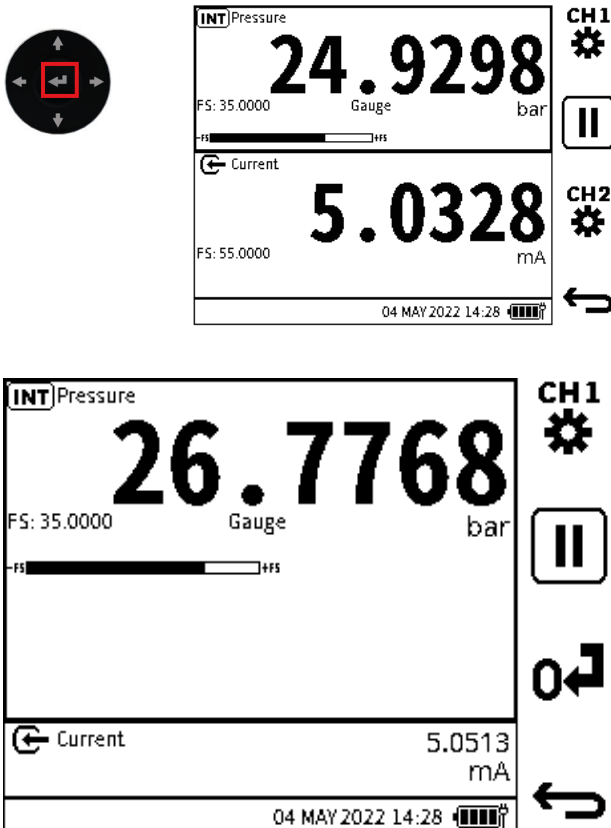
<p>Step 2</p>		<p>Press the Enter button to maximize the Channel window.</p>
---------------	--	--

i **INFORMATION** When in a maximized/minimized layout, the 50:50 layout can be restored by pressing the **ENTER** button.

Chapter 6. Calibrator Tasks

6.1.1.2 Change Measurement Units

To change the measurement units on each channel on the calibrator task screen:

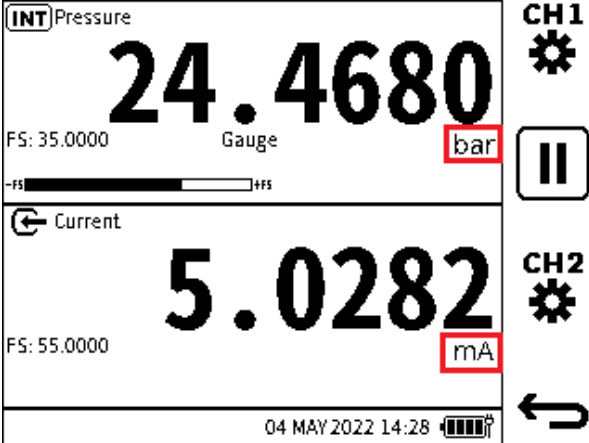
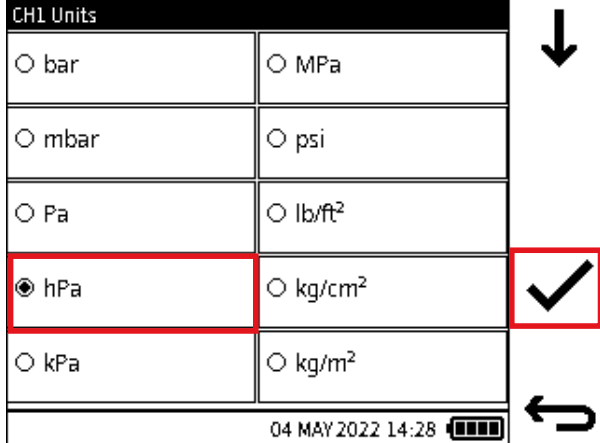
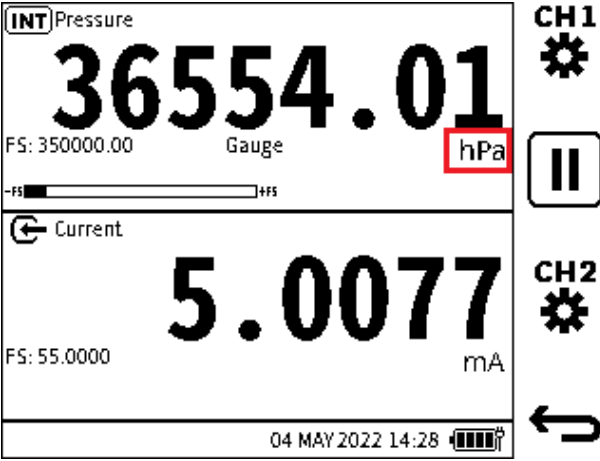
<p>Step 1</p>		<p>Select the units text on the relevant channel window.</p>
<p>Step 2</p>		<p>Select the desired unit from the CH Units screen. Select ✓ to confirm the selection.</p>
<p>Step 3</p>		<p>The desired unit appears on the configured channel window.</p>

6.1.1.3 10 V/24 V Loop Power Enable/Disable

The Loop Drive is the internal power supplied by the DPI 610E. It is available to use with any of the electrical functions listed in the **CH2 Setup** screen (to enable the Loop Power, see Section 6.2.9 on page 88).

When 10 V or 24 V Loop Power is enabled, it is displayed at the top of the **CH2** channel window (see Figure 6-2).

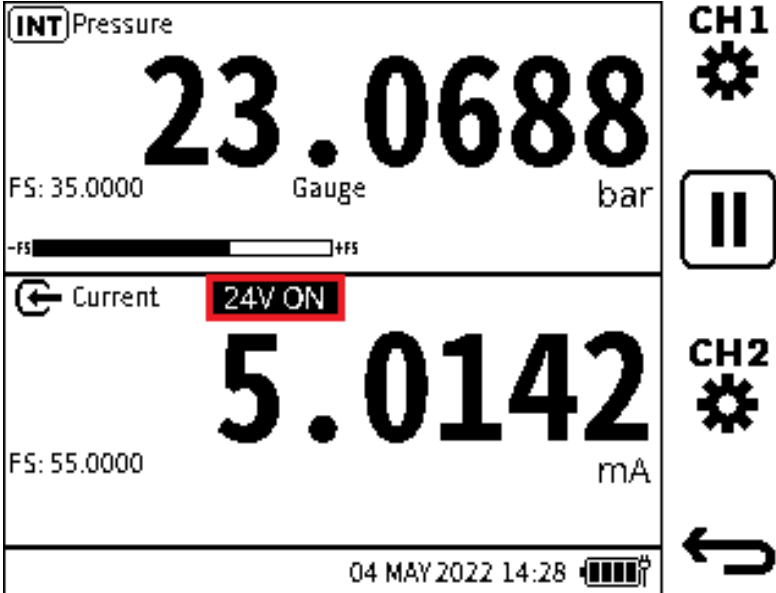
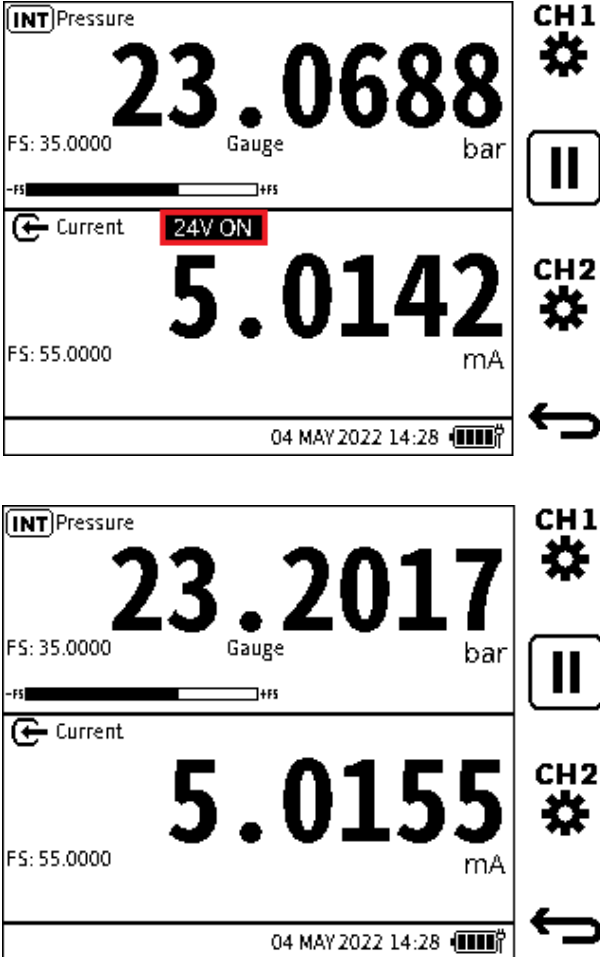

Figure 6-2: 24 V Loop Power Enabled

Chapter 6. Calibrator Tasks

The **Loop Power** function can be disabled quickly without leaving the Calibrator screen:

Using the Touchscreen

Step 1	 <p>The top screenshot shows the Calibrator screen with two channels. Channel 1 (CH1) is Pressure, showing a reading of 23.0688 bar. Channel 2 (CH2) is Current, showing a reading of 5.0142 mA. A red box highlights the text '24V ON' next to the current reading. The bottom screenshot shows the same screen, but the '24V ON' text is no longer present, indicating that the function has been disabled.</p>	<p>Tap on the 10 V/ 24 V text field in the Calibrator screen.</p> <p>Check that the 10 V/ 24 V function has been disabled: as shown by the removal of the voltage text field (e.g. 24V ON).</p>
--------	---	---

Using Navigation Buttons

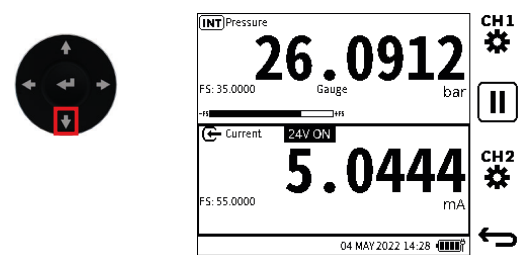
Step 1	 <p>The screenshot shows the Calibrator screen with a navigation pad icon to its left. The navigation pad has four arrows (UP, DOWN, LEFT, RIGHT) and a red box around the DOWN button. The Calibrator screen shows a pressure reading of 26.0912 bar and a current reading of 5.0444 mA. The '24V ON' text is present next to the current reading.</p>	<p>Press the DOWN button to select the channel 2 window area.</p>
--------	--	--

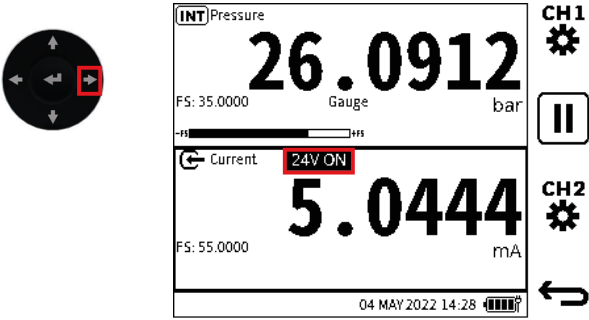
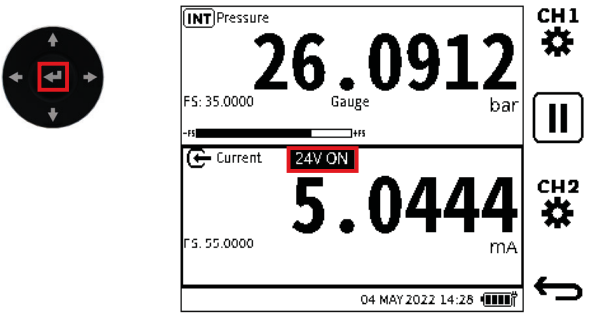
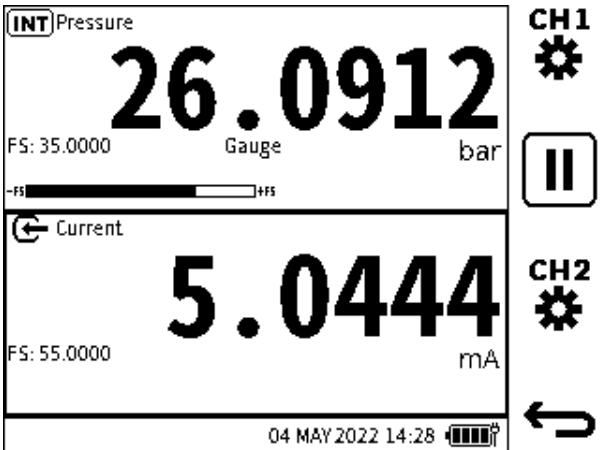
<p>Step 2</p>		<p>Press the RIGHT button until the 10V/24V text area is highlighted.</p>
<p>Step 3</p>		<p>Press the Enter Key to cancel the 24V ON function.</p>
<p>Step 4</p>		<p>Check that the 10 V/24 V function is not in the display because it has been disabled.</p>

Chapter 6. Calibrator Tasks

6.1.2 Error Indications

An out-of-range error message occurs when the values of the primary reading measure are more than the full-scale value of the function range.

Table 6-1: Error Indicators

Condition	Description	Depiction
Under-range	Measured reading < 110% of the negative full-scale value.	
Over-range	Measured reading > 110% positive full scale.	



INFORMATION If the display shows any of the above error indications: Check the sensor/measurement full scale pressure range (shown on screen) against the range of the system being measured.

6.2 Functions

6.2.1 Functions available by channel

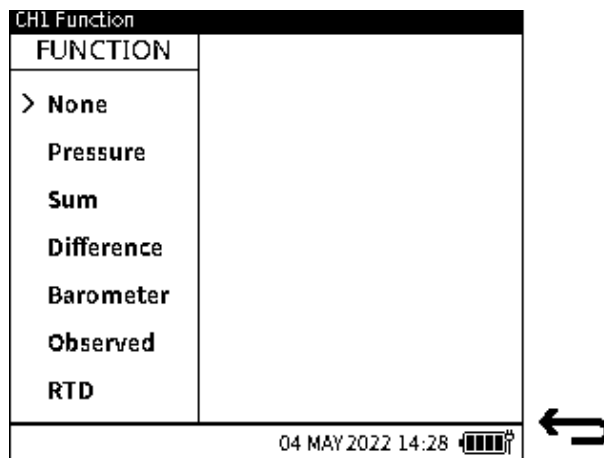

Figure 6-3: Channel 1 Functions

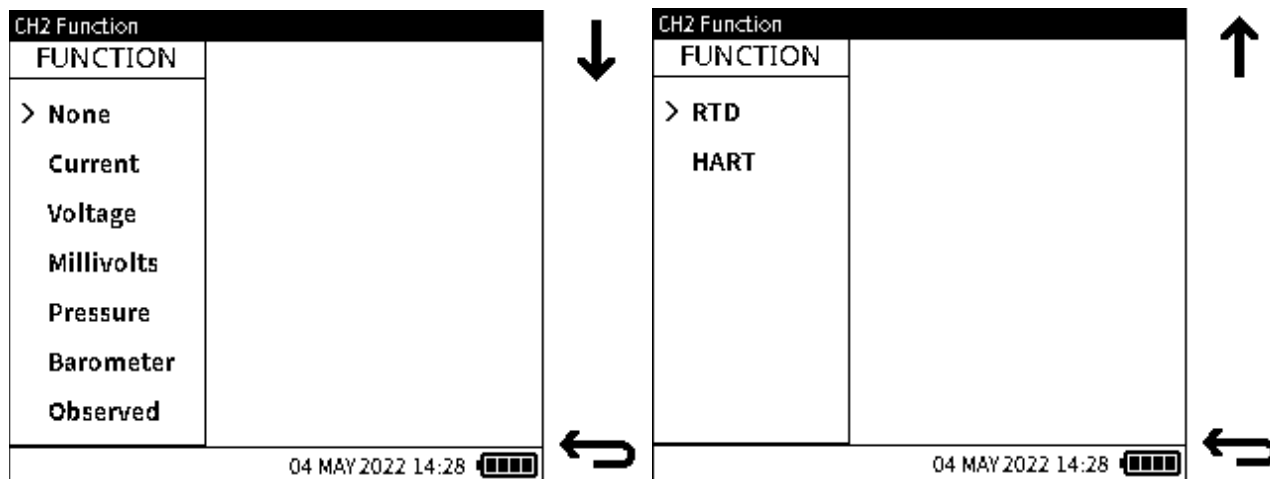

Figure 6-4: Channel 2 Functions

Chapter 6. Calibrator Tasks

Figure 6-5 is a channel function combination matrix. It shows the combinations of channel selections that are supported in the DPI 610E product range.

Figure 6-5: Channel Function Combination Matrix

			Channel 2										
			None	Electrical	Pressure				Barometer	Observed	RTD	HART	
					INT		Ext						
					Normal	Pseudo	Normal	Pseudo					
Channel 1	None		o	o	o	o	o	o	o	o	o		
	Pressure	INT	Normal	o	o	x	x	o	o	o	o	o	
			Pseudo	o	o	x	x	o	x	x	o	o	
		EXT	Normal	o	o	o	o	x	x	o	o	x	o
			Pseudo	o	o	o	x	x	x	x	o	x	o
Sum		o	o	x	x	x	x	o	o	o	o		
Difference		o	o	x	x	x	x	o	o	o	o		
Barometer		o	o	o	x	o	x	x	o	o	o		
Observed		o	o	o	o	o	o	o	o	o	o		
RTD		o	o	o	o	x	x	o	o	x	o		



INFORMATION 'Electrical' includes Current, Voltage and Millivolt functions.

Note: 'o' denotes a supported combination of functions.

Note: 'x' denotes that a combination of functions is not supported.

6.2.2 None

Users can select this function option if they do not wish to display any function or readings on the channel being setup. On the Calibrator main reading screen, the channel window will be cleared of all readings and information with only the function name present.

6.2.3 Pressure

6.2.3.1 Internal Pressure

Pneumatic units contain internal pressure sensors which range from 350 mbarg to 35barg. Hydraulic units contain internal pressure sensors which range from 70 bara/g to 1000bara. Available internal pressure sensors are listed in Table 6-2.

Table 6-2: Internal Pressure Sensors in DPI 610E Range

Pressure	Pressure Range Code	Pneumatic	Hydraulic
350 mbar / 5 psi / 35 kPa	03	G	-
1 bar / 15 psi / 100 kPa	05	G	-
2 bar / 30 psi / 200 kPa	07	G	-
3.5 bar / 50 psi / 350 kPa	08	G	-
7 bar / 100 psi / 700 kPa	10	G	-
10 bar / 150 psi / 1000 kPa	11	G	-
20 bar / 300 psi / 2 MPa	13	G	-
35 bar / 500 psi / 3.5 MPa	14	G	-
70 bar / 1000 psi / 7 MPa	16	-	G or A
100 bar / 1500 psi / 10 MPa	165	-	G or A
135 bar / 2000 psi / 13.5 MPa	17	-	G or A
200 bar / 3000 psi / 20 MPa	18	-	G or A
350 bar / 5000 psi / 35 MPa	20	-	A
700 bar / 10000 psi / 70 MPa	22	-	A
1000 bar / 15000 psi / 100 MPa	23	-	A















Chapter 6. Calibrator Tasks

To configure a pressure measurement reading from an internal sensor

<p>Step 1</p>		<p>Select the desired channel (Channel 1 in this example).</p>																								
<p>Step 2</p>		<p>Select FUNCTION in the Channel Setup screen.</p>																								
<p>Step 3</p>	<table border="1" data-bbox="300 1276 817 1729"> <thead> <tr> <th>FUNCTION</th> <th>SENSOR</th> <th>RANGE</th> </tr> </thead> <tbody> <tr> <td>None</td> <td>INT</td> <td>Normal</td> </tr> <tr> <td>Pressure</td> <td>EXT</td> <td>Pseudo</td> </tr> <tr> <td>Sum</td> <td></td> <td></td> </tr> <tr> <td>Difference</td> <td></td> <td></td> </tr> <tr> <td>Barometer</td> <td></td> <td></td> </tr> <tr> <td>Observed</td> <td></td> <td></td> </tr> <tr> <td>RTD</td> <td></td> <td></td> </tr> </tbody> </table>	FUNCTION	SENSOR	RANGE	None	INT	Normal	Pressure	EXT	Pseudo	Sum			Difference			Barometer			Observed			RTD			<p>Select Pressure in the Channel Function screen. Select INT. Select Normal or Pseudo.</p> <p>Select ✓ to confirm the selections.</p>
FUNCTION	SENSOR	RANGE																								
None	INT	Normal																								
Pressure	EXT	Pseudo																								
Sum																										
Difference																										
Barometer																										
Observed																										
RTD																										



INFORMATION See Chapter 6.2.3.4, “Normal and Pseudo Pressure Range,” on page 77.

<p>Step 4</p>	<table border="1"> <thead> <tr> <th colspan="3">CH1 Function</th> </tr> <tr> <th>FUNCTION</th> <th>SENSOR</th> <th>RANGE</th> </tr> </thead> <tbody> <tr> <td>None</td> <td>INT</td> <td>Normal</td> </tr> <tr> <td>Pressure</td> <td>EXT</td> <td>Pseudo</td> </tr> <tr> <td>Sum</td> <td></td> <td></td> </tr> <tr> <td>Difference</td> <td></td> <td></td> </tr> <tr> <td>Barometer</td> <td></td> <td></td> </tr> <tr> <td>Observed</td> <td></td> <td></td> </tr> <tr> <td>RTD</td> <td></td> <td></td> </tr> </tbody> </table> <p style="text-align: right;">   </p>	CH1 Function			FUNCTION	SENSOR	RANGE	None	INT	Normal	Pressure	EXT	Pseudo	Sum			Difference			Barometer			Observed			RTD			<p>Check that the desired configuration appears in the Channel Setup screen.</p> <p>Select  to return to the Calibrator Main screen.</p>
CH1 Function																													
FUNCTION	SENSOR	RANGE																											
None	INT	Normal																											
Pressure	EXT	Pseudo																											
Sum																													
Difference																													
Barometer																													
Observed																													
RTD																													
<p>Step 5</p>	<table border="1"> <tr> <td style="border: 1px solid black;"> <p>INT Pressure</p> <p style="font-size: 2em; font-weight: bold;">25.3775</p> <p>FS: 35.0000 Gauge bar</p> <p style="font-size: 1.2em;">5.0373</p> <p>FS: 55.0000 mA</p> </td> <td style="border: 1px solid black; vertical-align: top;"> <p>CH1 </p> <p></p> <p>CH2 </p> <p></p> </td> </tr> </table>	<p>INT Pressure</p> <p style="font-size: 2em; font-weight: bold;">25.3775</p> <p>FS: 35.0000 Gauge bar</p> <p style="font-size: 1.2em;">5.0373</p> <p>FS: 55.0000 mA</p>	<p>CH1 </p> <p></p> <p>CH2 </p> <p></p>	<p>Check that INT Pressure appears on top left corner of the desired channel screen.</p>																									
<p>INT Pressure</p> <p style="font-size: 2em; font-weight: bold;">25.3775</p> <p>FS: 35.0000 Gauge bar</p> <p style="font-size: 1.2em;">5.0373</p> <p>FS: 55.0000 mA</p>	<p>CH1 </p> <p></p> <p>CH2 </p> <p></p>																												

6.2.3.2 External Pressure

External pressure sensors (PM700E) are available in the range 25 mbarg/d to 1400 bara. Refer to “External Sensors” on page 141 for a list of available sensors, and information about how to configure the DPI 610E to recognize and use external sensors and RTD probes.

6.2.3.3 The Zero Function

The zero function is used on gauge sensors to remove offset drifts and therefore maintain the highest accuracy.



INFORMATION The Zero function is only available on gauge sensors. It is not possible to apply total vacuum to absolute sensors, as they are designed to measure atmospheric pressure.

Note: It is recommended that all gauge sensors are zeroed at the beginning of each day before use.

Chapter 6. Calibrator Tasks

To zero a sensor

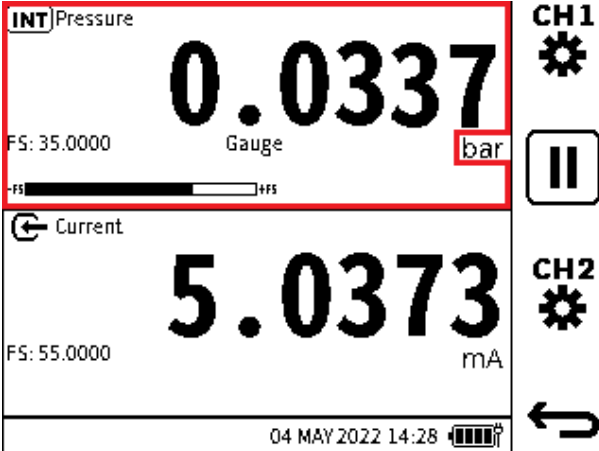
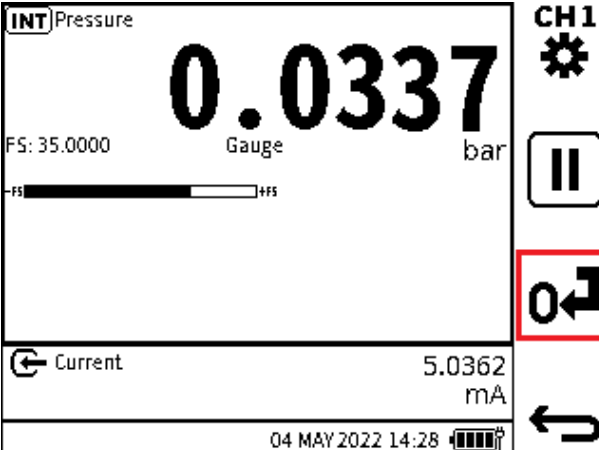
Step 1	See Chapter 2.1.3 on page 27 for pneumatic units or Chapter 2.2.4 on page 39 for hydraulic units.	Make sure that the sensor is open to atmosphere. Example: For the DPI 610E internal sensor, open the pressure release knob fully or make sure that the test port is open to atmosphere.
Step 2	See Chapter 6.2.3.1 (INT) or Chapter 6.2.3.2 (EXT).	Select the desired pressure function (INT or EXT) from the CH Setup menu on CH1 or CH2 .
Step 3		Expand the pressure channel by tapping anywhere in the channel window (except the Units area) (See Chapter 6.1.1.1, “Maximize and Minimize Channel Window,” on page 64).
Step 4		Select 0 to set the pressure sensor to zero.

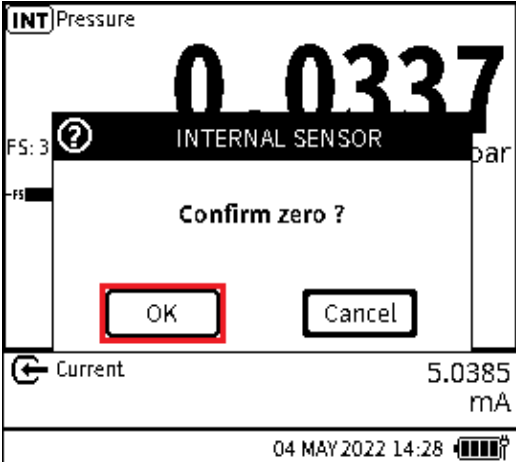
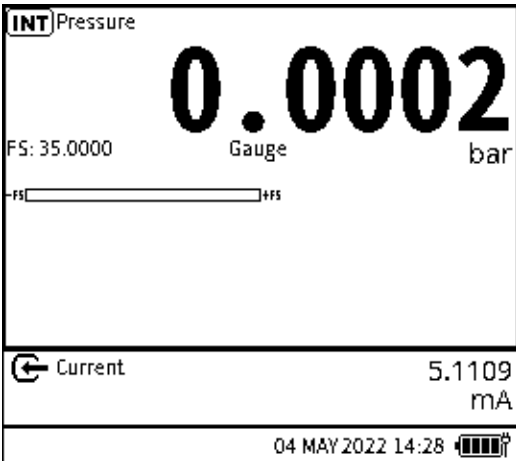
<p>Step 5</p>		<p>Select OK to confirm.</p>
<p>Step 6</p>		<p>Check that the desired pressure channel has been zeroed. Note: A Zero Error can occur if the pressure reading, measured from the sensor, is outside 1% of the full scale value when the instrument pressure port is opened to atmosphere.</p>

6.2.3.4 Normal and Pseudo Pressure Range

Internal and external pressure sensors are either gauge (measuring with respect to atmospheric pressure) or absolute (measuring with respect to vacuum). The measured readings from these sensors in their native form are referred to as ‘Normal’.

The sensors in pneumatic variants contain an accurate barometer which continuously measures the atmospheric pressure. This measured reading can be used to convert the internal (or external if present) pressure sensor reading from natively absolute to gauge or natively gauge to absolute. These pressure sensor modes are referred to as ‘Pseudo-gauge’ (natively absolute sensor to a gauge indication) and ‘Pseudo-abs’ (natively gauge sensor to absolute indication) respectively.

The hydraulic variants do not contain the barometer as it is not usual to require gauge readings at the higher pressure these hydraulic variants work at. Therefore the hydraulic variants do not support ‘Pseudo-gauge’ or ‘Pseudo-abs’ ranges.

6.2.3.5 Sealed Gauge Pressure Range

Hydraulic variants with internal or external absolute pressure sensors up to 10 bar and above, can use an atmospheric reading to convert the sensor reading to gauge by taring the atmospheric pressure value. This sensor mode is referred to as ‘Sealed Gauge’. When a supported absolute pressure sensor is connected and detected and the pressure function is configured on either channel, a pop-up window is displayed giving the option to use the sensor in absolute or sealed gauge mode.

Chapter 6. Calibrator Tasks

How to configure an External Sensor as a Sealed Gauge



The **EXT** Pressure function must be configured in one of the channels and you need to go into Calibrator to trigger this popup message.

<p>Step 1</p>		<p>Switch on the instrument and select the Calibrator icon and when the popup window appears select YES. If the instrument is already switched on select the CH1 or CH2 channel.</p>
---------------	--	--



INFORMATION If **NO** is selected, the sensor will be used in its native form - an **Absolute pressure sensor**.

<p>Step 2</p>		<p>Make sure that the pressure port is open to atmosphere and proceed when the pressure reading is stable. Select <input checked="" type="checkbox"/> to confirm.</p>
---------------	--	---

<p>Step 3</p>		<p>Make sure that Sealed Gauge is correctly configured on the desired channel.</p>
---------------	--	---

Internal Sensor



INFORMATION The INT Pressure function must be configured in one of the channels and you need to go into Calibrator to trigger this popup message.

<p>Step 1</p>		<p>Select YES.</p>
---------------	--	---------------------------



INFORMATION If **NO** is selected the sensor will be used in its native form - an Absolute pressure sensor.

<p>Step 2</p>		<p>Make sure that the pressure port is open to atmosphere. When the pressure reading is stable, select the ✓ icon.</p>
---------------	--	--

<p>Step 3</p>		<p>Make sure that Sealed Gauge is correctly configured on the desired channel.</p>
---------------	--	---

Chapter 6. Calibrator Tasks



6.2.4 Sum



Sum is a pressure related function which allows the internal pressure reading from the instrument to be combined with the pressure reading from an external sensor. An external pressure sensor must be connected to see the resulting reading on the **Calibrator Main** screen.

The **SUM** function is only available on **CH1**. If the **SUM** function is selected on **CH1**, the **INT** Pressure function or **EXT** Pressure function cannot be configured on **CH2**.

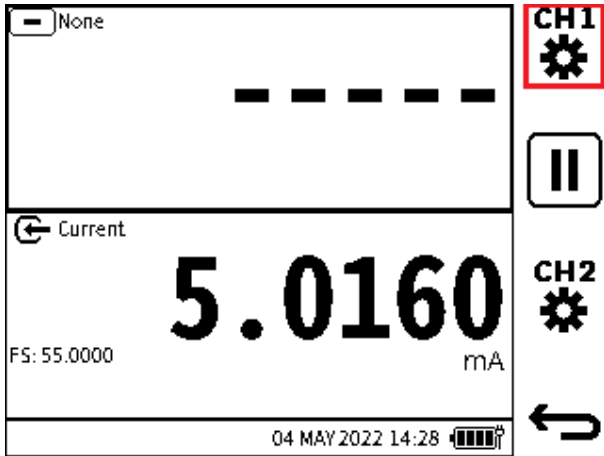
Note: Care should be taken when both sensors are not gauge, to make sure the contribution from atmospheric pressure has been considered.

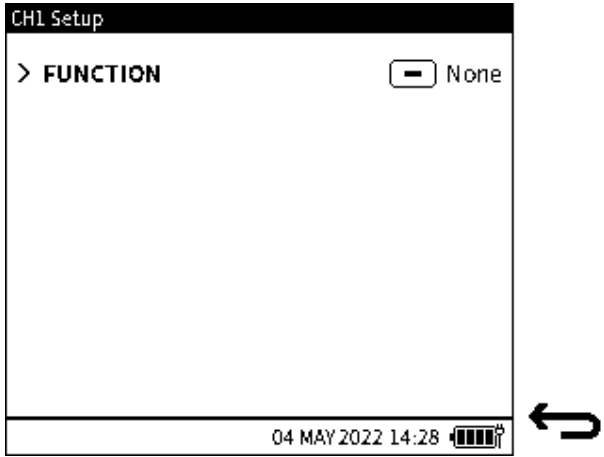
To configure a pressure measurement reading using the **Sum** function:

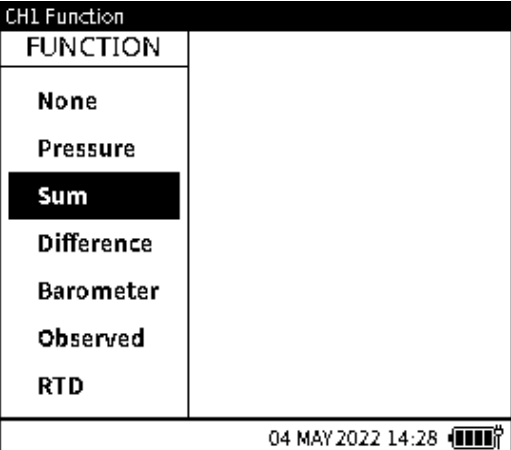
Step 1		Tap the CH1  icon to select Channel 1 or push the related softkey.
Step 2		Select FUNCTION from the Channel Setup menu.

<p>Step 3</p>		<p>Select Sum from the channel FUNCTION menu.</p> <p>Select ✓ to confirm. The CH Setup screen will appear again.</p>
<p>Step 4</p>		<p>Check that the desired configuration appears in the CH Setup menu.</p> <p>Select ↶ to go back to the Calibrator Main screen.</p>





Chapter 6. Calibrator Tasks

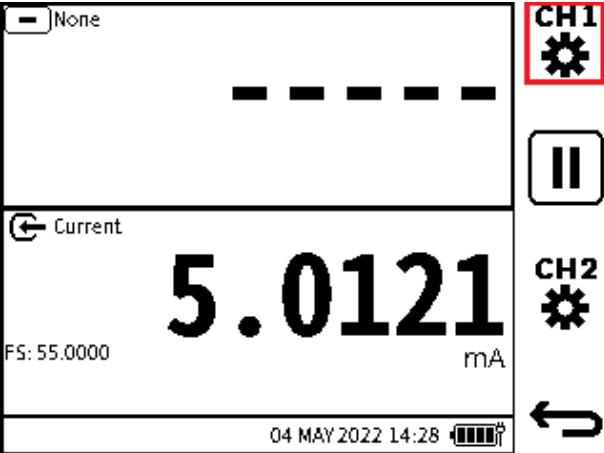

6.2.5 Difference

Difference is a pressure related function: this allows the difference between the internal pressure sensor reading and the external pressure sensor reading to be displayed on the calibrator task screen. An external pressure sensor must be connected to see the resulting pressure reading.

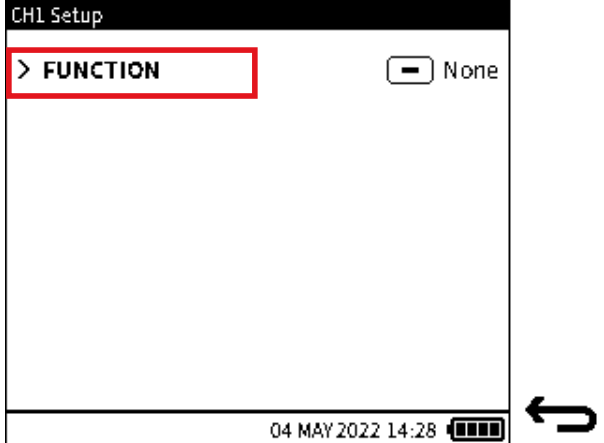
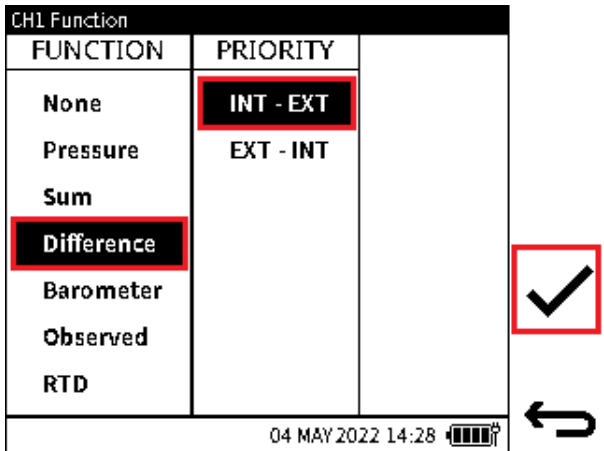
Note: Care should be taken when both sensors are not the same type (absolute/gauge) to ensure that the contribution from atmospheric pressure has been considered.

To configure a pressure measurement reading using the **Difference** function:

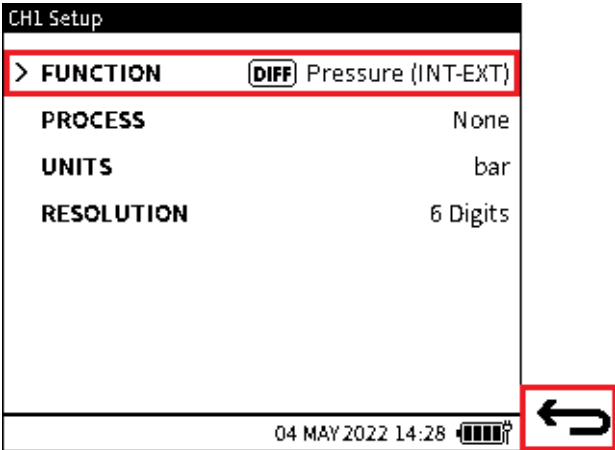
<p>Step 1</p>		<p>Tap the CH1  icon to select Channel 1 or push the related softkey.</p>
<p>Step 2</p>		<p>Select FUNCTION from the Channel Setup menu.</p>
<p>Step 3</p>		<p>Select Difference from the FUNCTION menu. Select INT-EXT or EXT-INT as desired. Select  to confirm.</p>

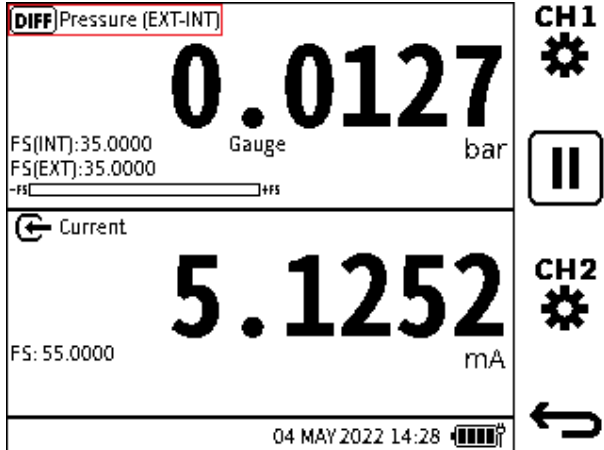
<p>Step 4</p>		<p>Check that the desired configuration appears in the CH Setup menu.</p> <p>Select  to return to the Calibrator Main screen.</p>
<p>Step 5</p>		<p>Confirm that the Difference function is correctly configured on the desired channel.</p> <p>The Difference icon (DIFF) together with the function name will be Pressure (INT-EXT) or (EXT-INT) depending on the priority chosen. The FS values of both the internal sensor and the external sensor will also be displayed. The sensor type field will also be updated where required.</p>



Chapter 6. Calibrator Tasks

6.2.6 Barometer

The internal Barometer has a range of 750 to 1150 mbar. The **Barometer** function allows the measured atmospheric pressure to be displayed on the **Calibrator Main** reading screen as a primary reading. The internal barometer is only available in the pneumatic variant.

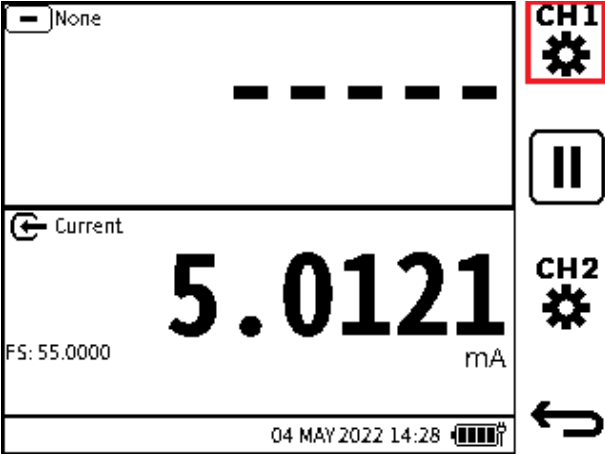
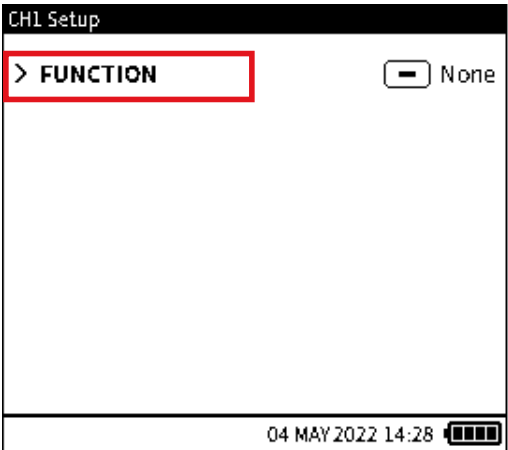
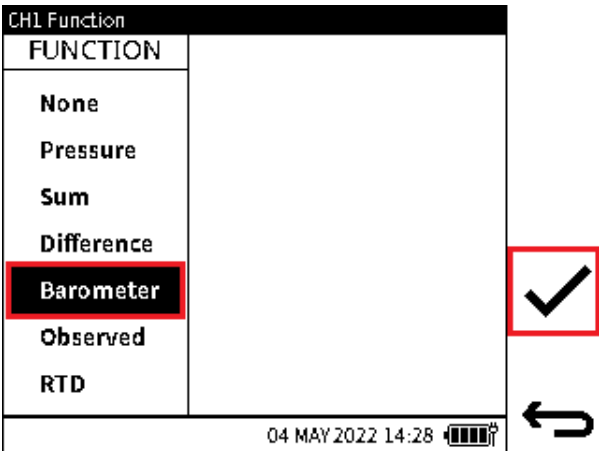
To configure a pressure measurement reading using the Barometer function:

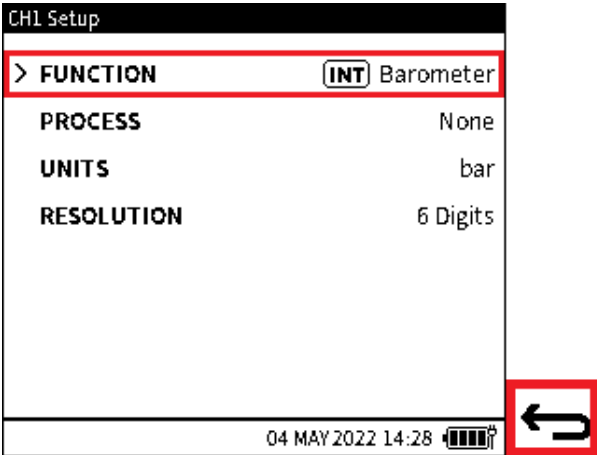
Step 1		Select the CH1 or CH2 icon as desired.
Step 2		Select FUNCTION from the Channel Setup menu to show the CHL Function screen.
Step 3		Select Barometer in the channel FUNCTION menu. Select the Tick <input checked="" type="checkbox"/> button to confirm the selection.

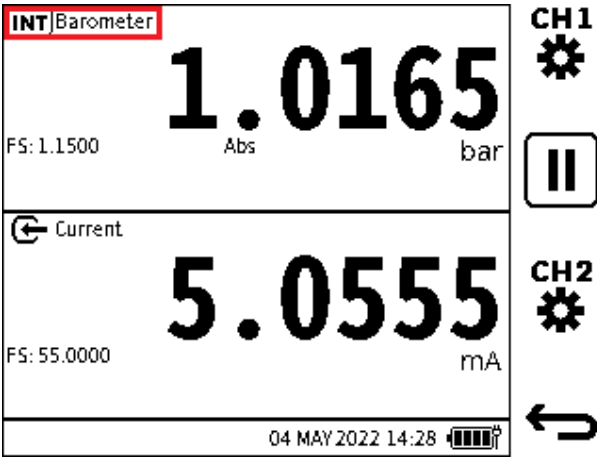



<p>Step 4</p>		<p>Confirm that the INT Barometer function appears in the CH Setup menu.</p> <p>Select the Back  icon to go to the Calibrator Main Screen.</p>
<p>Step 5</p>		<p>Check that the Barometer function is correctly configured in the desired channel window.</p>

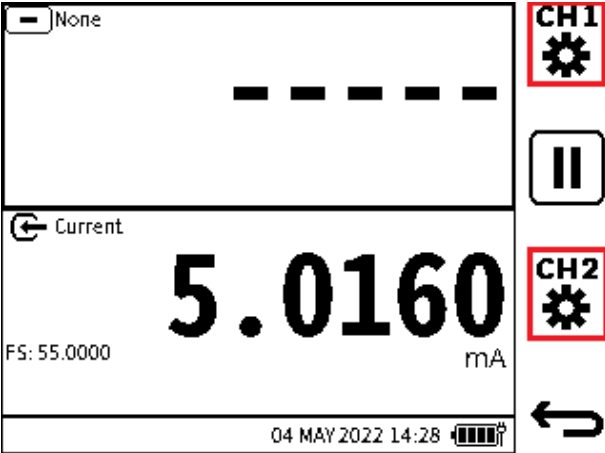

Chapter 6. Calibrator Tasks

6.2.7 Observed

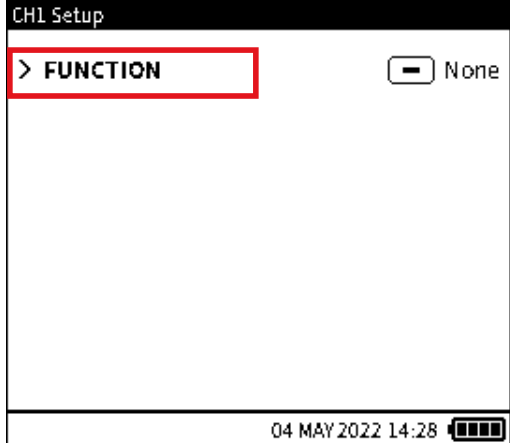
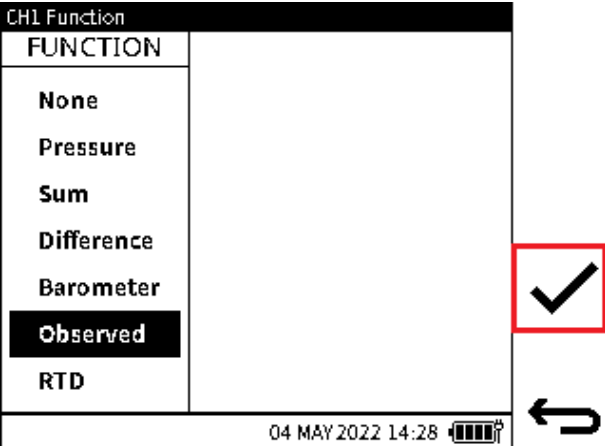
The **Observed** function is a non-measured function and has a range of +/- 999999.9. It allows manual entry of an observed reading from an external measuring and indicating device. It is often used in conjunction with a second measured function on another channel to record the relationship between the two readings.

To configure a channel using the **Observed** function:

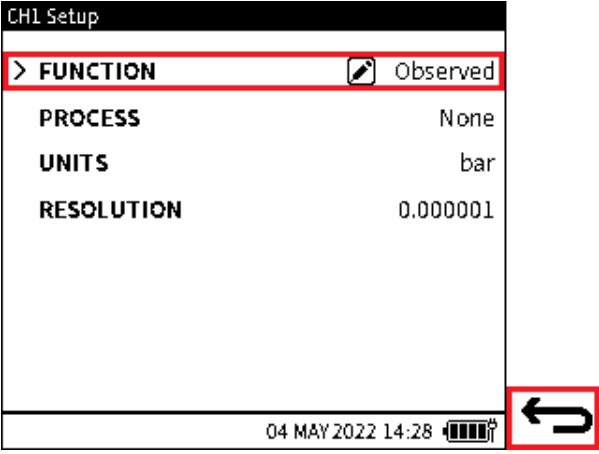
Step 1		Select the  or  as desired.
Step 2		Select FUNCTION from the Channel Setup menu.
Step 3		Select Observed from the channel FUNCTION menu. Select the Tick  button to confirm the selection.

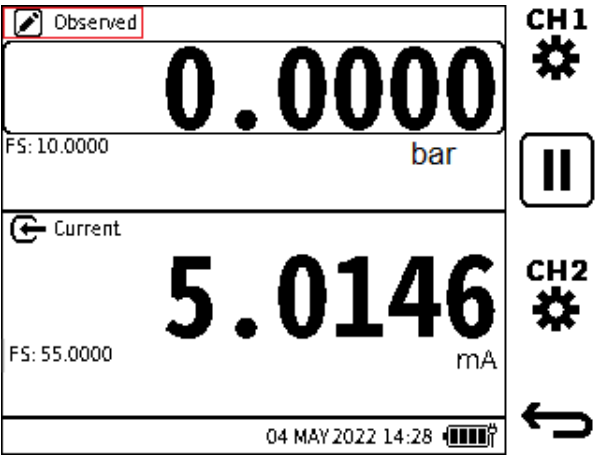
<p>Step 4</p>		<p>Check that the Observed function appears in the CH Setup menu.</p> <p>Select  to return to the Calibrator Main screen.</p>
<p>Step 5</p>		<p>The Observed message will appear in the top left corner of the screen display.</p> <p>To select a different unit of measurement, refer to Section 6.1.1.2 on page 66 for instructions.</p>

6.2.8 RTD

The RTD function enables temperature or resistance measurements to be displayed on the **Calibrator** main reading screen as a primary reading when the RTD-Probe is connected to the DPI 610E via the RTD-Interface (or RTD-Interface-IS).

When the RTD-Interface connection is detected, the sensor icon is shown in the status bar and the “Connected” text is briefly displayed to confirm successful connection. Upon disconnection, the sensor icon will disappear and the “Disconnected” text is briefly displayed to confirm the connection has been lost.

Chapter 6. Calibrator Tasks

6.2.9 Current





The current measurement range: +/- 55 mA.

The DPI 610E can measure or source electrical current expressed in milliamps (mA). Only **CH2** can do this. When using the **CH2 Current** function, there is the additional option to use the internal 10 V (non-IS instruments only) or 24 V power supply provided by DPI 610E or to use an external power supply for the device under test.

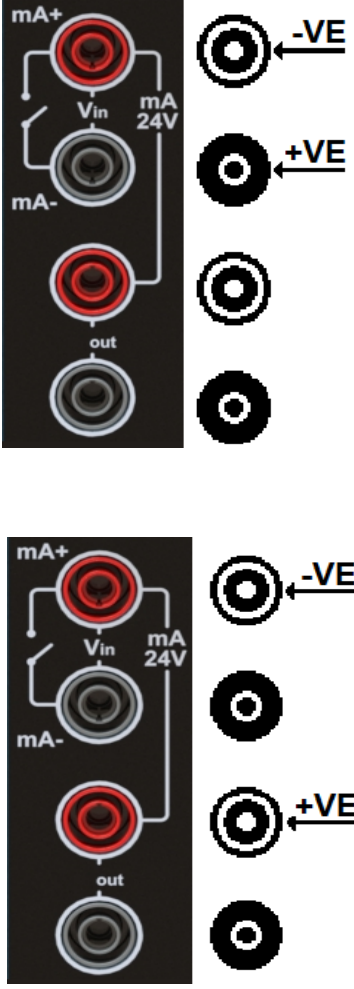

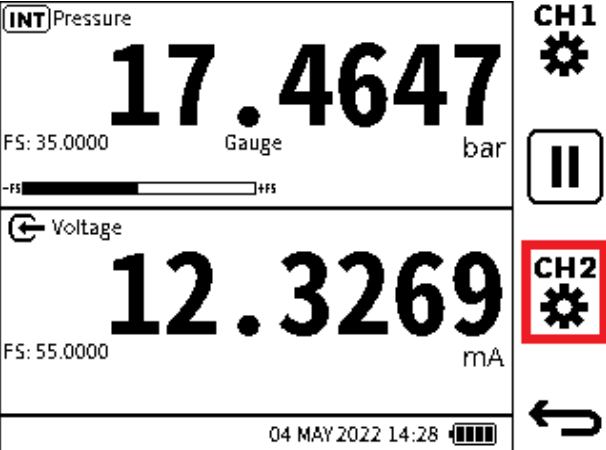
6.2.9.1 Current Measure

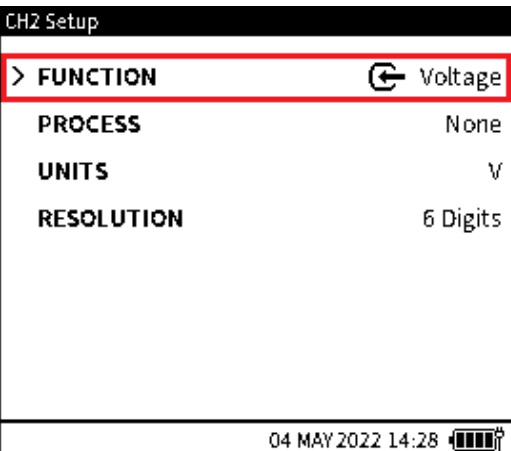
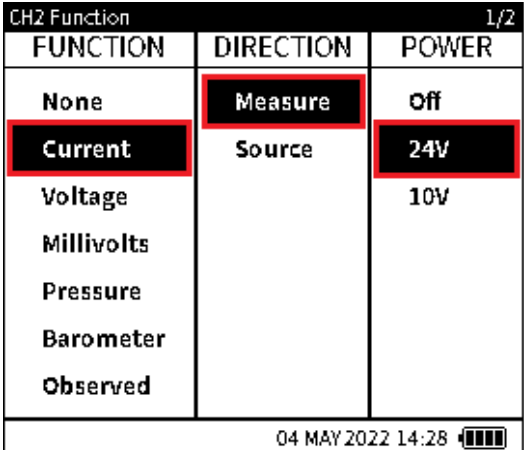
It is necessary to use the correct terminals to configure the **Current Measure** function:

Step 1	 <p>The diagrams illustrate the terminal connections for the Current Measure function. The top diagram shows connections for an external power supply: mA+ to -VE, mA- to +VE, and Vin to mA 24V. The bottom diagram shows connections for internal power supply: mA+ to -VE, mA- to +VE, and Vin to mA 24V.</p>	<p>Use the diagram on the left to make the necessary connections for Current Measure when the 10/24V internal power supply is not used (the Off option is selected in Step 4).</p> <p>Use the diagram on the left to make the necessary connections for Current Measure using the internal 10 V or 24 V supply.</p>
--------	--	--

<p>Step 2</p>		<p>Select the  channel.</p>																											
<p>Step 3</p>		<p>Select FUNCTION from the CH2 Setup screen.</p>																											
<p>Step 4</p>	 <table border="1" data-bbox="303 1245 829 1693"> <thead> <tr> <th colspan="2">CH2 Function</th> <th>1/2</th> </tr> <tr> <th>FUNCTION</th> <th>DIRECTION</th> <th>POWER</th> </tr> </thead> <tbody> <tr> <td>None</td> <td>Measure</td> <td>Off</td> </tr> <tr> <td>Current</td> <td>Source</td> <td>24V</td> </tr> <tr> <td>Voltage</td> <td></td> <td>10V</td> </tr> <tr> <td>Millivolts</td> <td></td> <td></td> </tr> <tr> <td>Pressure</td> <td></td> <td></td> </tr> <tr> <td>Barometer</td> <td></td> <td></td> </tr> <tr> <td>Observed</td> <td></td> <td></td> </tr> </tbody> </table>	CH2 Function		1/2	FUNCTION	DIRECTION	POWER	None	Measure	Off	Current	Source	24V	Voltage		10V	Millivolts			Pressure			Barometer			Observed			<p>Select Current > Measure > then select one of the following: 10 V for measure with internal 10 V Loop Power supply (only for non-IS units) OR 24 V for measure with internal 24 V Loop Power supply.</p> <p>Select  to confirm the selection. If Off is selected the electrical connections will not be the same as for when 24 V or 10 V is selected (see Step 1).</p>
CH2 Function		1/2																											
FUNCTION	DIRECTION	POWER																											
None	Measure	Off																											
Current	Source	24V																											
Voltage		10V																											
Millivolts																													
Pressure																													
Barometer																													
Observed																													

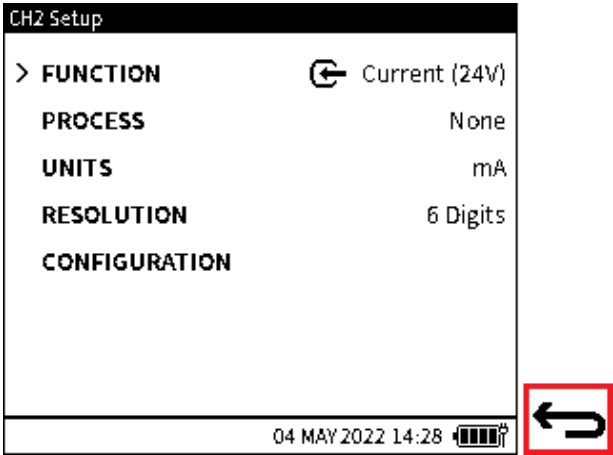
Chapter 6. Calibrator Tasks

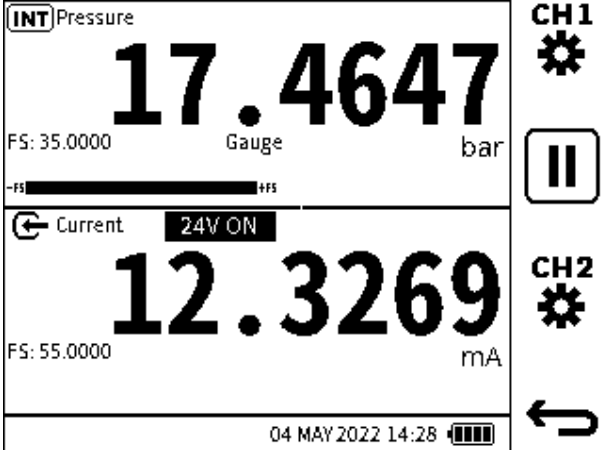
Step 5		<p>This screen will have only “Current” as the Function when Off is selected. When 24V is selected, “Current (24V)” will appear. When 10V is selected, “Current (10V)” will appear.</p> <p>Select the Back  icon to go to the Calibrator Main Screen.</p>
		<p>The Calibration screen will show “10V ON” or “24V ON” in the CH2 screen area. If Off has been selected, only “Current” will be in the top of this area.</p>

6.2.9.2 Current Source

To configure the **Current Source** function:

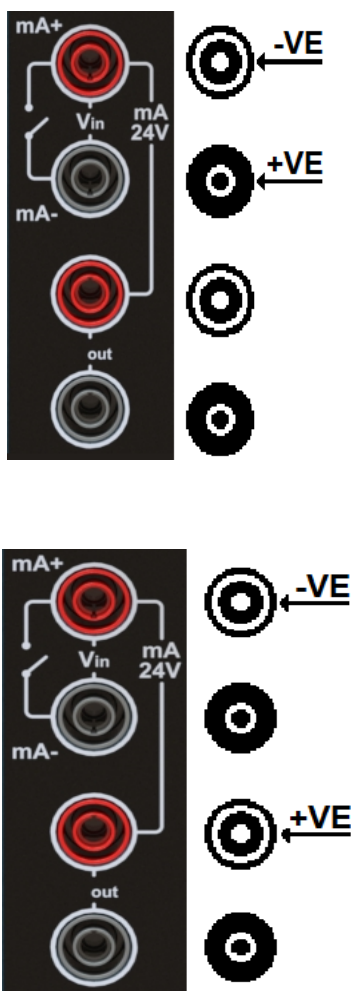
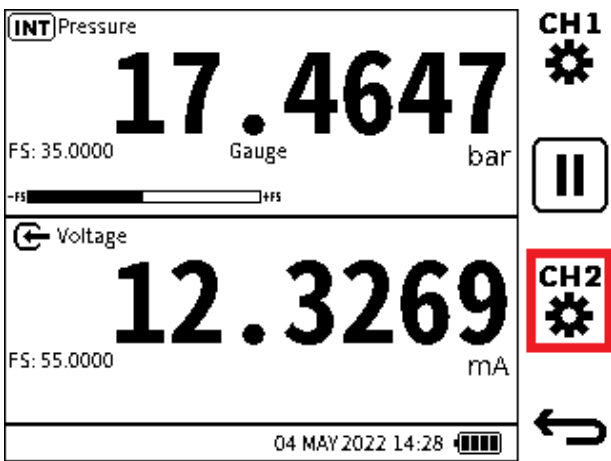
<p>Step 1</p>		<p>Use the diagram on the left to make the necessary connections for Current Source when the 10/24V internal power supply is not used (when the Off option is selected in Step 4).</p> <p>Use the diagram on the left to make the necessary connections for Current Source using the internal 10 V or 24 V supply.</p>
<p>Step 2</p>		<p>Select the CH2 channel.</p>

Chapter 6. Calibrator Tasks

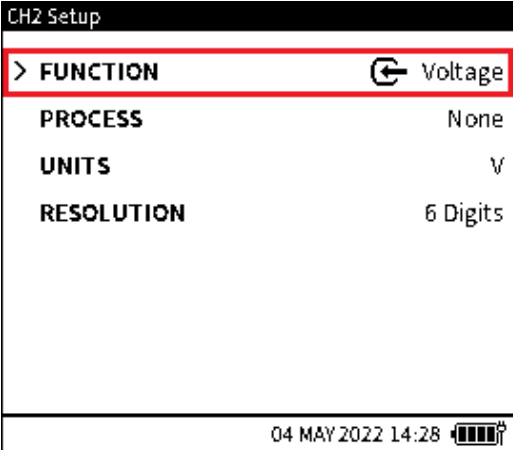
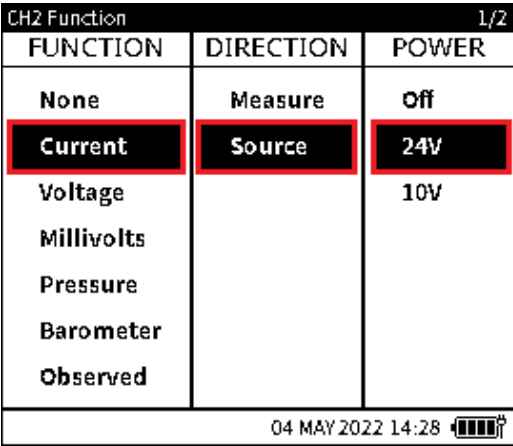
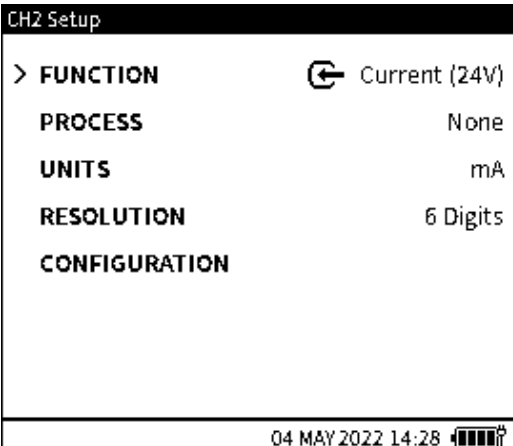
<p>Step 3</p>	 <p>CH2 Setup</p> <p>> FUNCTION ← Voltage</p> <p>PROCESS None</p> <p>UNITS V</p> <p>RESOLUTION 6 Digits</p> <p>04 MAY 2022 14:28</p>	<p>Select FUNCTION from the Channel Setup menu.</p>																								
<p>Step 4</p>	 <p>CH2 Function 1/2</p> <table border="1"> <thead> <tr> <th>FUNCTION</th> <th>DIRECTION</th> <th>POWER</th> </tr> </thead> <tbody> <tr> <td>None</td> <td>Measure</td> <td>Off</td> </tr> <tr> <td>Current</td> <td>Source</td> <td>24V</td> </tr> <tr> <td>Voltage</td> <td></td> <td>10V</td> </tr> <tr> <td>Millivolts</td> <td></td> <td></td> </tr> <tr> <td>Pressure</td> <td></td> <td></td> </tr> <tr> <td>Barometer</td> <td></td> <td></td> </tr> <tr> <td>Observed</td> <td></td> <td></td> </tr> </tbody> </table> <p>04 MAY 2022 14:28</p>	FUNCTION	DIRECTION	POWER	None	Measure	Off	Current	Source	24V	Voltage		10V	Millivolts			Pressure			Barometer			Observed			<p>Select Current > Source > then select one of the following: 10 V for measure with internal 10 V Loop Power supply (only for non-IS units) OR 24 V for measure with internal 24 V Loop Power supply.</p> <p>Select ✓ to confirm the selection. If Off is selected the electrical connections will not be the same as for when 24 V or 10 V is selected (see Step 1).</p>
FUNCTION	DIRECTION	POWER																								
None	Measure	Off																								
Current	Source	24V																								
Voltage		10V																								
Millivolts																										
Pressure																										
Barometer																										
Observed																										
	 <p>CH2 Setup</p> <p>> FUNCTION ← Current (24V)</p> <p>PROCESS None</p> <p>UNITS mA</p> <p>RESOLUTION 6 Digits</p> <p>CONFIGURATION</p> <p>04 MAY 2022 14:28</p>	<p>This screen will have only “Current” as the Function when Off is selected. When 24V is selected, “Current (24V)” will appear. When 10V is selected, “Current (10V)” will appear.</p> <p>Select the Back ← icon to go to the Calibrator Main screen</p>																								

Direct Input of Current Value

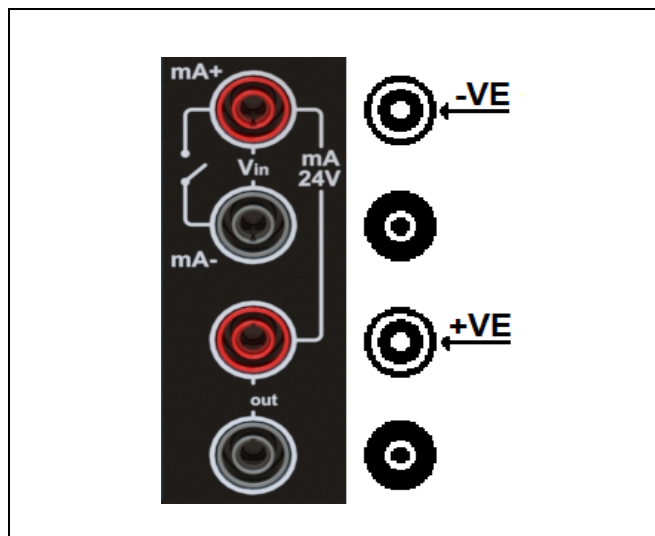

The DPI 610E can provide electrical current accurately within the 0 to 24 mA range. The diagram on the left shows the terminal connections for this configuration.

You can directly input the current value to be sourced. First select the type of test to be done (See Section 3.2 on page 42). The Touchscreen or the Navigation Pad can then be used to input this current value:

	<p>Use the Touchscreen to set the source current</p> <p>Tap in the Current Value field. Enter the required current source value using the UP/DOWN arrow icons on the left of the field.</p>
	<p>Use the Navigation Pad to set the source current</p> <p>Press the DOWN button to select the CH2 window area. Press the RIGHT button until the source value is outlined in bold.</p> <p>Press the OK (Enter) button to show the source value entry screen. Enter the new value using the onscreen keyboard and press the Tick softkey to confirm.</p>

Chapter 6. Calibrator Tasks

INFORMATION Once a target current source value is set, the displayed value will start to flash. Once the setpoint has been reached, the source value will stop flashing and remain steady.



The other methods to set the current source output are:

1. Nudge (manual)
2. Span Check (manual or automated)
3. Percent Step (manual or automated)
4. Defined Step (manual or automated)
5. Ramp (automated).

These methods are explained in this chapter, however, the Configuration Options must first be set before these methods can be used. Make sure the type of test has been selected (See Section 3.2 on page 42), to make the required screens be available.

Configuration Options

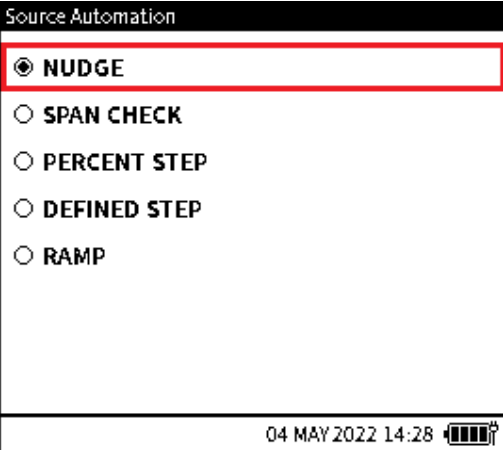
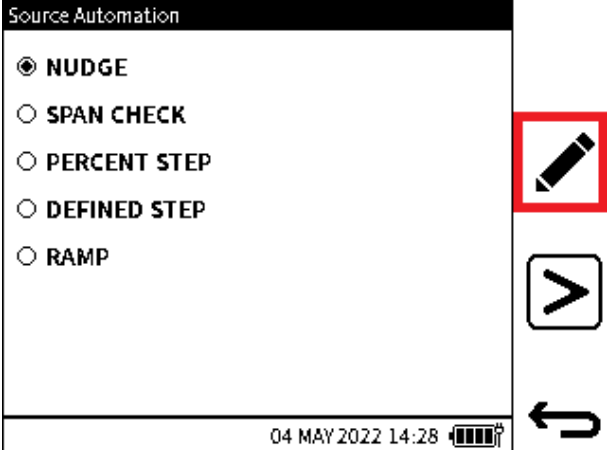





Step 1		<p>Tap on the CH2 window (anywhere except the Units area) or, if using the navigation keypad, press the DOWN button to select CH2, then press the OK button to expand the channel window.</p>
Step 2		<p>Select the Tool options icon to show the Source Automation screen</p>

<p>Step 3</p>		<p>Select the desired option from the Source Automation screen, for example: NUDGE.</p>
<p>Step 4</p>		<p>If required, select the Edit  softkey to configure the selected automation. Note: Different automation options will have different configuration parameters.</p>

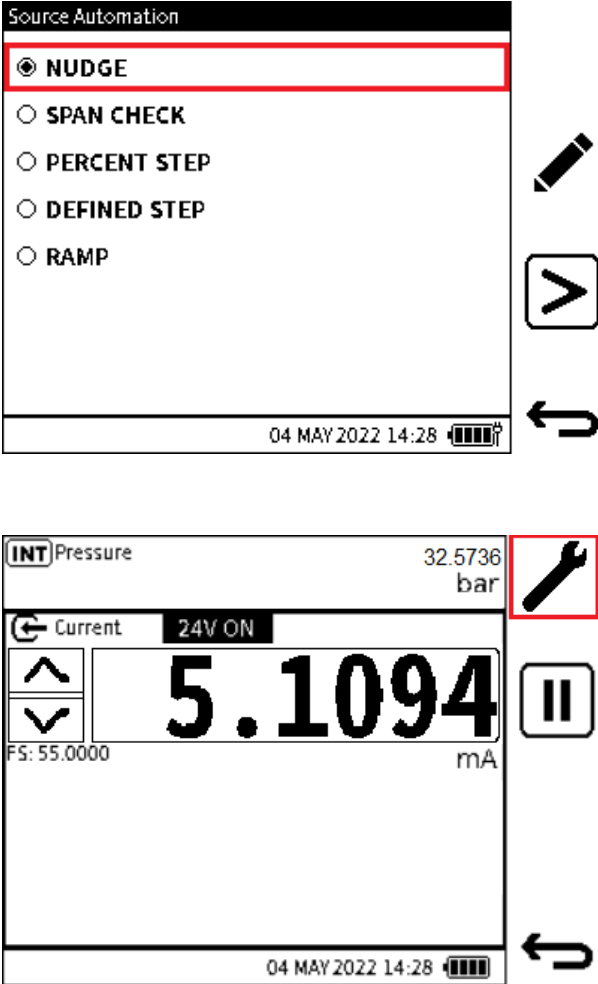
Chapter 6. Calibrator Tasks

1. NUDGE

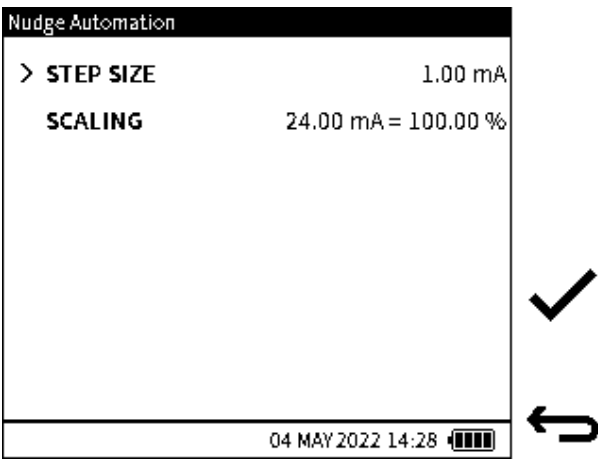
This is the default **Source Automation** option. It allows the source value to be incremented or decremented by a defined step size value. This can be achieved in the current source channel window by:





<p>Step 1</p>	 <p>The first screenshot shows the 'Source Automation' menu with 'NUDGE' selected. The second screenshot shows the 'Current' window with a value of 5.1094 mA and the 'Edit' softkey highlighted.</p>	<p>To use the screen. From the Source Automation screen select the NUDGE radio button and then the Edit  softkey to show the Nudge Automation screen. The Nudge Automation data will appear. Go to step 2 to change this data if required.</p> <p>Click the Proceed  icon to activate the option and return to the Calibrate screen.</p> <p>To use the Navigation Pad. When using the keypad, press the DOWN button to select the CH2 window. Press the Edit  softkey to show the Nudge Automation screen. The Nudge Automation data will appear. Go to step 2 to change this data if required.</p>
<p>Step 2</p>	 <p>The screenshot shows the 'Nudge Automation' screen with 'STEP SIZE' set to 1.00 mA and 'SCALING' set to 24.00 mA = 100.00 %.</p>	<p>Select the STEP SIZE row to show an onscreen keypad, enter the new value using the onscreen or Navigator keys.</p> <p>Tap the Back  icon to enter the value and return to the Calibrator screen.</p> <p>For a description of Scaling refer to Section 6.3.6 on page 122.</p>

2. SPAN CHECK

Span Check is normally used to check the span of a device under test by providing the minimum current output corresponding to the device's zero or negative full-scale, and the maximum current output corresponding to the positive full-scale of the device under test. For most current output devices, this minimum and maximum values are 4 and 20 mA respectively. These are the default values for the Span Check automation.

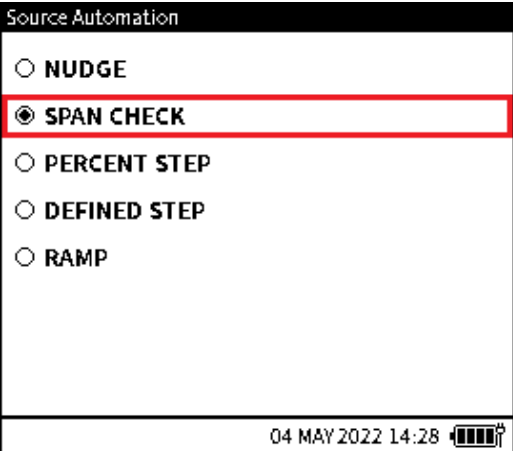
The **SPAN CHECK** function allows a 2-point span check. **LOW** (minimum) and **HIGH** (maximum) span values can be set. The **DWELL** time is the interval to wait at each Span Point before changing to the other span point and vice versa.

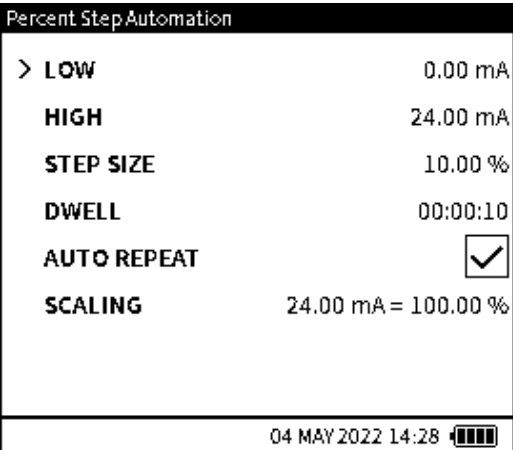
To change the **LOW** or **HIGH** span values or the **DWELL** time:

<p>Step 1</p>	 <p>The screenshot shows the 'Source Automation' menu with options: NUDGE, SPAN CHECK (selected and highlighted with a red box), PERCENT STEP, DEFINED STEP, and RAMP. To the right of the screen are three softkey icons: a pencil (Edit), a right-pointing arrow (Proceed), and a curved arrow (Back). The status bar at the bottom shows '04 MAY 2022 14:28' and a battery icon.</p>	<p>From the Source Automation screen tap the SPAN CHECK radio button to show the Span Check Automation screen.</p> <p>If required, select the Edit softkey to change the selected automation values.</p> <p>Click the Proceed  icon to activate the option and return to the Calibrate screen.</p>
<p>Step 2</p>	 <p>The screenshot shows the 'Percent Step Automation' screen with parameters: LOW (0.00 mA), HIGH (24.00 mA), STEP SIZE (10.00 %), DWELL (00:00:10), AUTO REPEAT (checked), and SCALING (24.00 mA = 100.00 %). To the right of the screen are two softkey icons: a checkmark and a curved arrow (Back). The status bar at the bottom shows '04 MAY 2022 14:28' and a battery icon.</p>	<p>Select the parameter value to be changed.</p> <p>Select the parameter row to show an onscreen keypad, enter the new value using the onscreen or Navigator keys.</p> <p>Tap the Back  icon to enter the value and return to the Calibrator screen.</p> <p>For a description of Scaling refer to Section 6.3.6 on page 122.</p>

Chapter 6. Calibrator Tasks

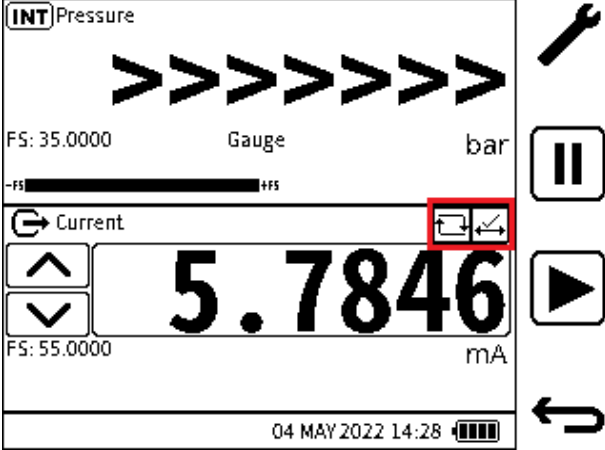
Step 3		The Calibrator screen will have two additional icons indicating that the Span Check mode is active and the Auto-repeat operation is available.
--------	---	---

LOW value - is the first current source value to be set using this option.



HIGH value - is the maximum current source value set-point using this option.

DWELL - the time interval which can be set to wait at the low value before changing to the high value and vice versa.

SCALING - refer to Section 6.3.6 on page 122 for a description of the use of Scaling.





When **Span Check** automation is selected, the **Span Check**  icon is displayed on the top right of the **CH2** window on the calibrator screen.

The span check can be run manually by using the **UP** and **DOWN** nudge buttons to switch between the **LOW** and **HIGH** source values. It can also be automated by pressing the automation **Play** softkey.

The **Auto-repeat**  icon is also displayed next to the **Span Check** automation  icon, as the **Span Check** cycle is automatically repeated when using the automation **Play**  softkey, until manually stopped. To stop the automation at any time, press the **Cancel** softkey.

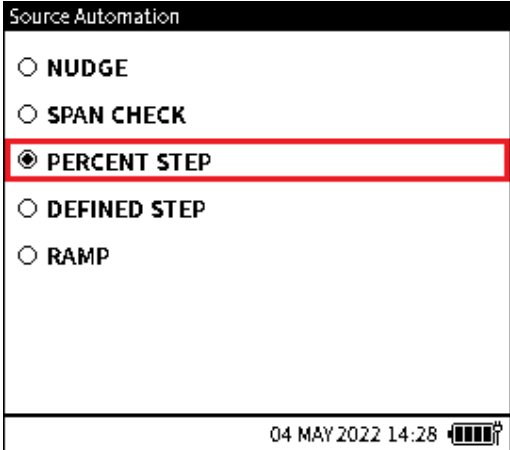
3. PERCENT STEP

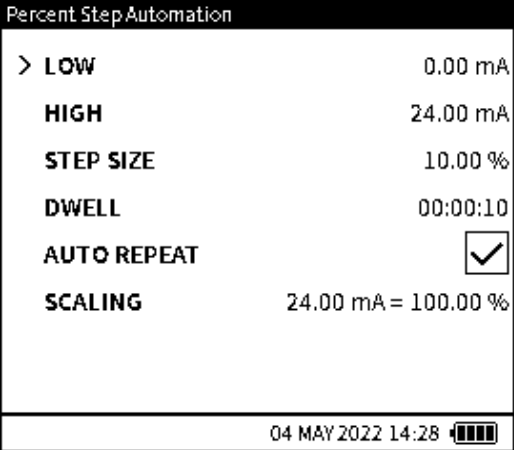
The **PERCENT STEP** function allows the source value to be incremented in steps that correspond to a set percentage of the span. The Low, High and Step size value can be set as well as the option to auto-repeat this automation process.

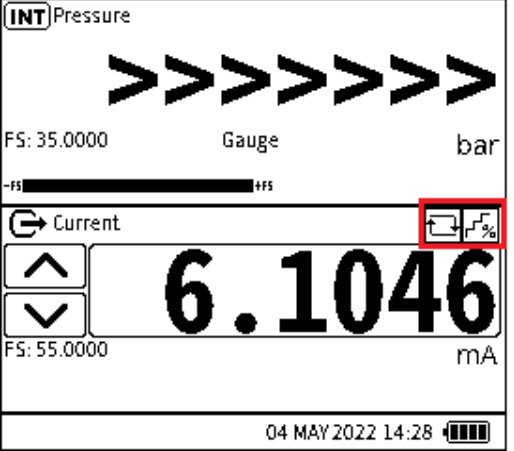
<p>Step 1</p>	 <p>Source Automation</p> <ul style="list-style-type: none"> <input type="radio"/> NUDGE <input type="radio"/> SPAN CHECK <input checked="" type="radio"/> PERCENT STEP <input type="radio"/> DEFINED STEP <input type="radio"/> RAMP <p>04 MAY 2022 14:28</p>	<p>From the Source Automation screen tap the PERCENT STEP radio button to show the Percent Step Automation screen.</p> <p>If required, select the Edit softkey to change the selected automation values.</p> <p>Click the Proceed  icon to activate the option and return to the Calibrate screen.</p>
<p>Step 2</p>	 <p>Percent Step Automation</p> <ul style="list-style-type: none"> > LOW 0.00 mA HIGH 24.00 mA STEP SIZE 10.00 % DWELL 00:00:10 AUTO REPEAT <input checked="" type="checkbox"/> SCALING 24.00 mA = 100.00 % <p>04 MAY 2022 14:28</p>	<p>Select the parameter value to be changed.</p> <p>Select the parameter row to show an onscreen keypad, enter the new value using the onscreen or Navigator keys.</p> <p>Tap the Back  icon to enter the value and return to the Calibrator screen.</p> <p>For a description of Scaling refer to Section 6.3.6 on page 122.</p>
<p>Step 3</p>	 <p>INT Pressure</p> <p>>>>>>>>></p> <p>FS: 35.0000 Gauge bar</p> <p>Current 6.1046 mA</p> <p>FS: 55.0000</p> <p>04 MAY 2022 14:28</p>	<p>The Calibrator screen will have two additional icons indicating that the Percent Check mode is active and the Auto-repeat operation is available.</p>

LOW value - is the first current source value to be set using this option.

HIGH value - is the maximum current source value set-point using this option.

Chapter 6. Calibrator Tasks

STEP SIZE value - is the magnitude of each step increment or decrement. When using this option, it is expressed as a percentage. The resulting mA step size will be based on the step size percentage of the LOW and HIGH value.

DWELL - time interval which can be set to wait at each set-point value before changing to the next value.

AUTO-REPEAT - the tickbox option which allows the automation cycle to be repeated indefinitely until manually stopped.

SCALING - refer to Section 6.3.6 on page 122 for a description of the use of Scaling.



When selected, the **Percent Step**  icon is displayed at the top right of the **CH2** window on the calibrator screen.



The **Percent Step** sequence can be run manually by using the **UP** and **DOWN** nudge buttons to increment and decrement the source values. It can also be automated by pressing the automation **Play**  softkey.

If selected in the configuration, the **Auto-repeat**  icon appears next to the **Percent Step** automation  icon. The automation cycle is automatically repeated until manually stopped. To stop the automation at any time, press the **Cancel** softkey.

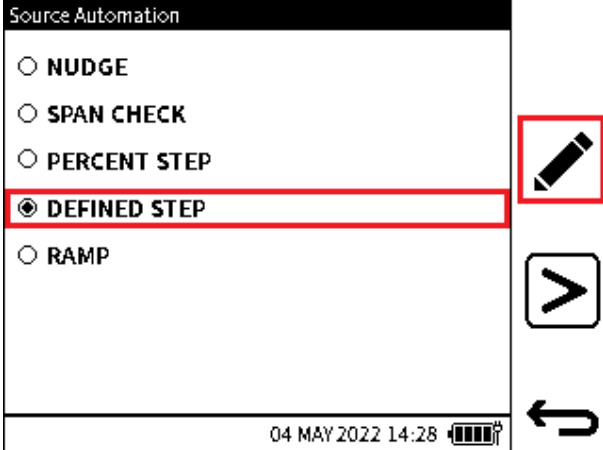
4. DEFINED STEP

The **DEFINED STEP** function allows incremental source values using a defined step size within the span limits. The **LOW**, **HIGH** and **Step Size** value can be set as well as the option to auto-repeat the automation process.

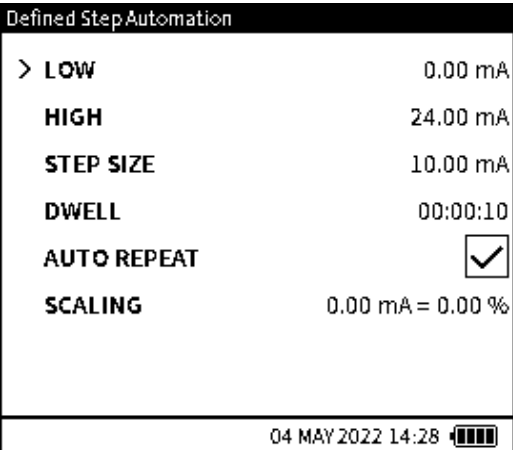
Step 1		<p>From the Source Automation screen tap the DEFINED STEP radio button to show the Defined Step Automation screen.</p> <p>If required, select the Edit softkey to change the selected automation values.</p> <p>Click the Proceed  icon to activate the option and return to the Calibrate screen.</p>
--------	---	---

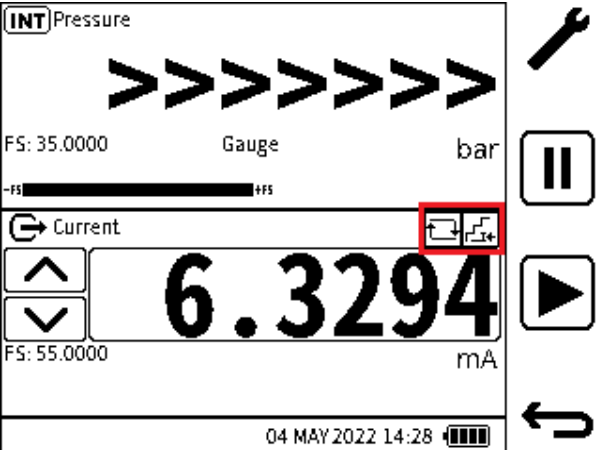
<p>Step 2</p>		<p>Tap or select the parameter value to be changed. Select the parameter row to show an onscreen keypad, enter the new value using the onscreen or Navigator keys.</p> <p>Tap the Back  icon to enter the value and return to the Calibrator screen.</p> <p>For a description of Scaling refer to Section 6.3.6 on page 122.</p>
<p>Step 3</p>		<p>The Calibrator screen will have two additional icons indicating that the Defined Step mode is active and the Auto-repeat operation is available.</p>

LOW value - is the first current source value to be set using this option.

HIGH value - is the maximum current source value set-point using this option.



STEP SIZE value - is the magnitude of each step increment or decrement. When using this option, it is expressed as mA.

DWELL - time interval which can be set to pause or wait at each set-point value before changing to the next value.

AUTO-REPEAT - the tickbox option which allows the automation cycle to be repeated indefinitely until manually stopped.

When selected, the **Defined Step**  icon is displayed at the top right of the **CH2** window on the Calibrator screen.

The **Defined Step** sequence can be run manually by using the **UP** and **DOWN** nudge buttons to increment and decrement the source values. It can also be automated by pressing the automation **Play**  softkey.





If selected in the configuration, the **Auto-repeat**  icon is also displayed next to the **Defined Step** automation  icon. The automation cycle is automatically repeated until manually stopped.

To stop the automation at any time, press the **Cancel** softkey.

Chapter 6. Calibrator Tasks

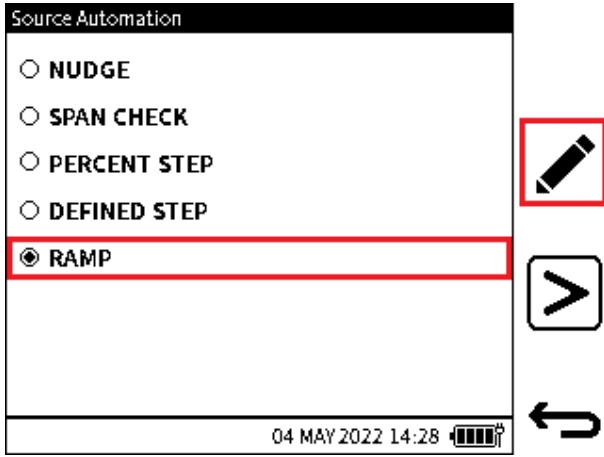
5. RAMP

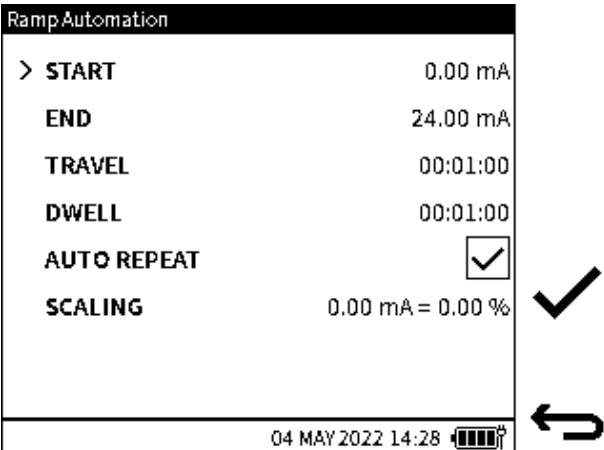
The **RAMP** function allows the source value to be automatically incremented from a defined **START** value to a defined **END** value in steps of a defined value in both increasing and decreasing direction. The **TRAVEL** time can be set to define the period of time it takes the value to go from **START** to **END** (and vice versa).

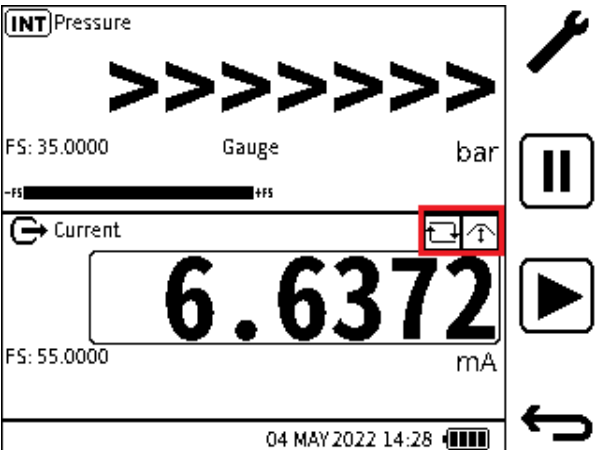
<p>Step 1</p>	 <p>The screenshot shows the 'Source Automation' menu with options: NUDGE, SPAN CHECK, PERCENT STEP, DEFINED STEP, and RAMP. The RAMP option is selected and highlighted with a red box. To the right of the screen, a pencil icon (Edit) is also highlighted with a red box. Below the screen are icons for 'Proceed' (a right-pointing arrow) and a refresh icon.</p>	<p>From the Source Automation screen tap the RAMP radio button to show the Ramp Automation screen.</p> <p>If required, select the Edit  softkey to change the selected automation values.</p> <p>Click the Proceed  icon to activate the option and return to the Calibrate screen.</p>
<p>Step 2</p>	 <p>The screenshot shows the 'Ramp Automation' screen with parameters: START (0.00 mA), END (24.00 mA), TRAVEL (00:01:00), DWELL (00:01:00), AUTO REPEAT (checked), and SCALING (0.00 mA = 0.00 %). A tick icon is highlighted to the right of the SCALING parameter. Below the screen are icons for 'Proceed' (a right-pointing arrow) and a refresh icon.</p>	<p>Tap or select the parameter value to be changed.</p> <p>Use the onscreen keypad to change the value.</p> <p>For a description of Scaling refer to Section 6.3.6 on page 122.</p> <p>Select the Tick icon  to set the new values.</p>
<p>Step 3</p>	 <p>The screenshot shows the 'Calibrator' screen for 'Current' measurement. The value 6.6372 mA is displayed. Above it, a gauge for 'Pressure' is shown with a series of right-pointing arrows. A wrench icon is visible in the top right. Below the screen are icons for 'Proceed' (a right-pointing arrow) and a refresh icon.</p>	<p>The Calibrator screen will have two additional icons indicating that the Ramp mode is active and the Auto-repeat operation is available.</p>

START value - is the first current source value to be set using this option.

END value - is the maximum current source value set-point using this option.

TRAVEL - time required for the current source value to ramp from the Start value to the End value. This automatically calculates the required step size to be used to achieve the travel time.

DWELL - time interval which can be set to pause or wait at the end of each direction or travel before changing to the opposite direction of travel.

AUTO-REPEAT - the tickbox option which allows the automation cycle to be repeated indefinitely until manually stopped.

When selected, the **Ramp**  icon is displayed at the top right of the **CH2** window on the **Calibrator** screen.

The Ramp sequence is not manual and hence the **UP** and **DOWN** nudge buttons are not usable with this option. It is automated by pressing the automation **Play**  softkey.

If selected in the configuration, the **Auto-repeat**  icon is also displayed next to the **Ramp** automation  icon. The automation cycle is automatically repeated until manually stopped.

To stop the automation at any time, press the **Cancel**  softkey.

Chapter 6. Calibrator Tasks

6.2.10 Voltage

	<p>For the DPI 610E instrument voltage is measured in Volts (V) or milliVolts (mV) and is a function of CH2 only. When the Voltage function is selected, the Direction is automatically set to Measure, as the Source option is not supported by the DPI 610E.</p> <p>The supported voltage range is -30 V to 30 V.</p> <p>When using the Voltage function, there is the additional option to use the internal 10 V (non-IS units only) or 24 V power supply provided by DPI 610E or to measurement of the voltage input from a source that is powered external to the unit.</p> <p>Terminal connections for measurement of Volts are shown in the diagram on the left.</p>
--	--

6.2.10.1 Voltage Measure - Configuration:

<p>Step 1</p>		<p>From the Calibrator screen, select the channel 2 CH2 Setup screen (either press the screen icon or press the softkey.)</p>
<p>Step 2</p>		<p>Select FUNCTION from the CH2 Setup screen.</p>

Step 3

CH2 Function		
FUNCTION	DIRECTION	LOOP
None	Measure	Off
Current		24V
Voltage		10V
Millivolts		
Pressure		
Barometer		
Observed		

04 MAY 2022 14:28



CH2 Setup	
> FUNCTION	← Voltage
PROCESS	None
UNITS	mA
RESOLUTION	6 Digits

04 MAY 2022 14:28



INT Pressure	24.4680	bar
FS: 35.0000	Gauge	
← Voltage	5.0282	mA
FS: 55.0000		

04 MAY 2022 14:28



Select **Voltage > Measure** then select one of the following:
Off for measurement without internal loop power supply OR
10 V for measure with internal 10 V loop power supply (only for non-IS units) OR
24 V for measure with internal 24 V loop power supply.

Select the Tick icon to confirm the selection and configure the instrument.

Check that Voltage mode is active.

Select the **Back** icon to show the **Calibration** screen.

Check that Voltage is shown in screen.

Chapter 6. Calibrator Tasks

6.2.11 Millivolts Measure - Configuration

	<p>Voltage can also be measured in millivolts (mV) and is a function of CH2 only. When the Millivolts function is selected, the Direction is automatically set to Measure as the Source option is not supported by the DPI 610E. The supported millivolts range is -2000 mV to 2000 mV. When using the Millivolts function, there is the additional option to use the internal 10 V (non-IS units only) or 24 V power supply provided by DPI 610E or to measure the millivolts input from a source that is powered external to the unit. Terminal connections for measurement of millivolts are shown in diagram on the left.</p>
--	--

<p>Step 1</p>		<p>From the Calibrator screen, select the Channel 2 Setup (either press the screen icon or press the softkey.)</p>
<p>Step 2</p>		<p>Select FUNCTION from the CH2 setup screen.</p>

Step 3

CH2 Function 1/2		
FUNCTION	DIRECTION	POWER
None	Measure	Off
Current		24V
Voltage		10V
Millivolts		
Pressure		
Barometer		
Observed		

04 MAY 2022 14:28



CH2 Setup	
> FUNCTION	← Millivolts
PROCESS	None
UNITS	mV
RESOLUTION	6 Digits

04 MAY 2022 14:28



INT Pressure

24.4680

FS: 35.0000 Gauge bar

← Millivolts

5.0282

FS: 55.0000 mA

04 MAY 2022 14:28



Select **Millivolts > Measure** then select one of the following:
Off for measurement without internal loop power supply OR
10 V for measure with internal 10 V loop power supply (only for non-IS units) OR
24 V for measure with internal 24 V loop power supply.

Select the Tick icon to confirm the selection and configure the instrument.

Check that Voltage mode is selected.

Select the **Back** icon to show the **Calibration** screen.

Check that Millivolts is shown in screen.

Chapter 6. Calibrator Tasks

6.2.12 HART

The DPI 610E can use the **HART** (Highway Addressable Remote Transducer) communication protocol and allows basic HART operation and configuration on HART supported devices. The HART bi-directional communications technology works as a master/slave protocol and when connecting the DPI 610E to the HART device, the DPI 610E acts as the master and the HART device, the slave. The DPI 610E supports commonly used functions from the Universal and Common Practice commands specified in HART revision 5, 6 and 7. (See more on HART in Chapter 12 on page 205).

The HART function is only available on **CH2**. As it utilizes the current loop signal for its communication, the DPI 610E can provide 10 V/24 V loop power supply to the HART device if required.

The DPI 610E also offers an optional 250-ohm resistor that provides the voltage drop required for the HART communication when an external HART resistor is not available.

The HART resistor can be enabled (and disabled) from the **CH2 Setup** window.

To select the **HART** function:

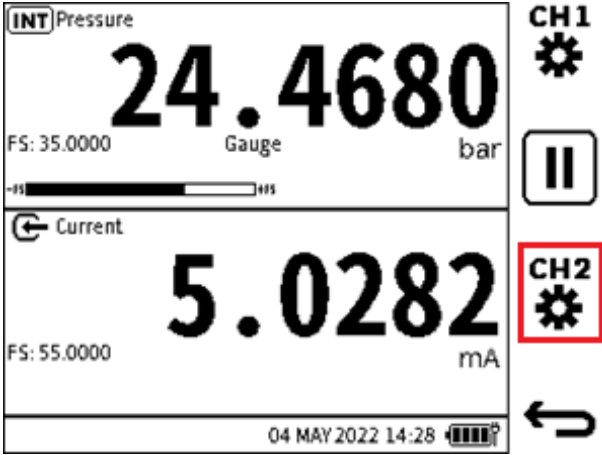
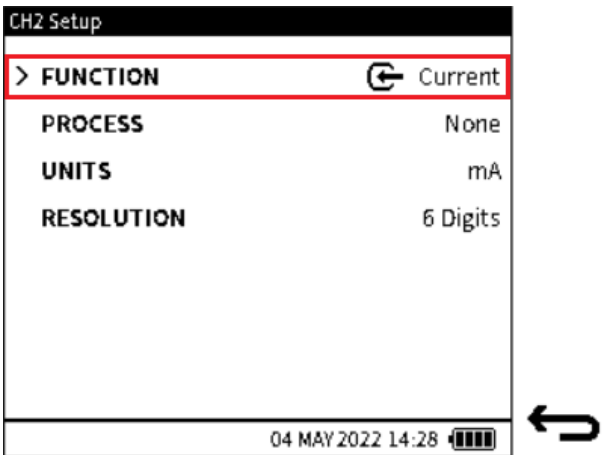
<p>Step 1</p>		<p>From the Calibrator screen, select the channel 2 CH2 Setup (either tap the screen icon or press the softkey.)</p>
<p>Step 2</p>		<p>Select FUNCTION from the CH2 Setup screen.</p>

Step 3

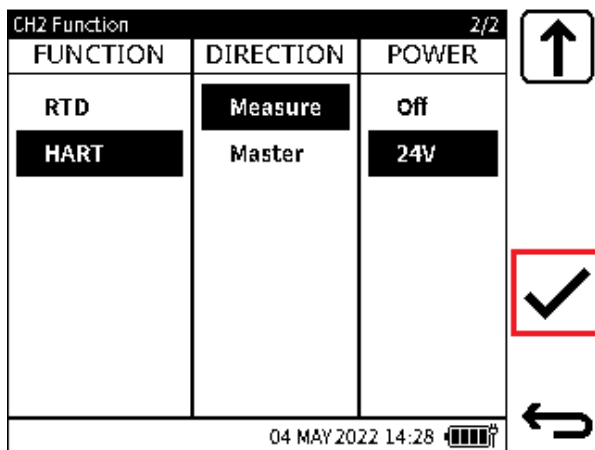
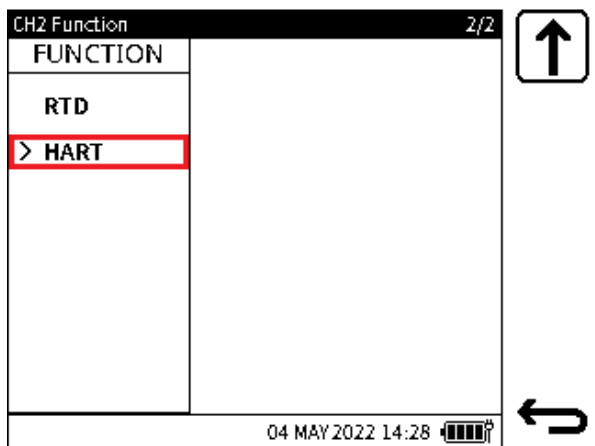
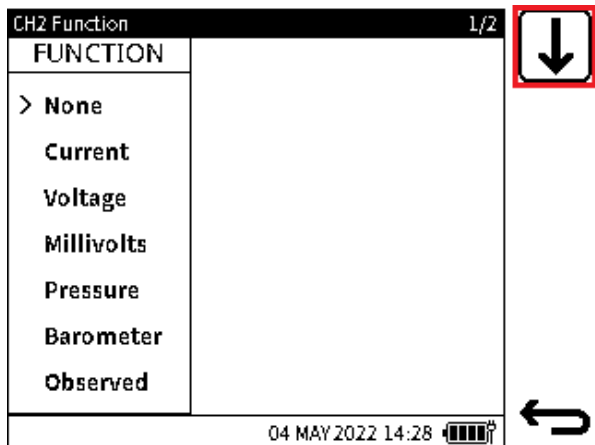

Select **None** in the **FUNCTION** column and tap the page down softkey to view the second page of **CH2** functions.

Tap **HART** on the second screen to view the two more selection columns. Select the required options in the

columns and then select the Tick  icon to confirm the selection and configure the instrument.

The **HART** configuration screen will appear. Make more selections on this screen or select the **Back** icon to show the **Calibration Main** screen.

For more details on how to set up the **HART** application and the **HART** device, see Chapter 12 on page 205.

To cancel the **HART** function, to enable the selection of another function, use the procedure given in Section 12.2 on page 209 to return to the **Configuration** screen.

6.3 Process Options

6.3.1 Tare





The Tare function is used to set the channel readings to a temporary zero. When Tare is enabled, the primary reading value is deducted from subsequent reading values until Tare is disabled. The initial reading will be approximately zero.

For example, if the reading from the internal pressure sensor is 21.4985 bar at the time Tare is enabled, the reading becomes approximately 0.000 as the value 21.4985 is captured and subtracted from true reading and the resulting value is then displayed. Whenever Tare is enabled, the Tare symbol will be displayed on the relevant channel window to indicate it is in operation.

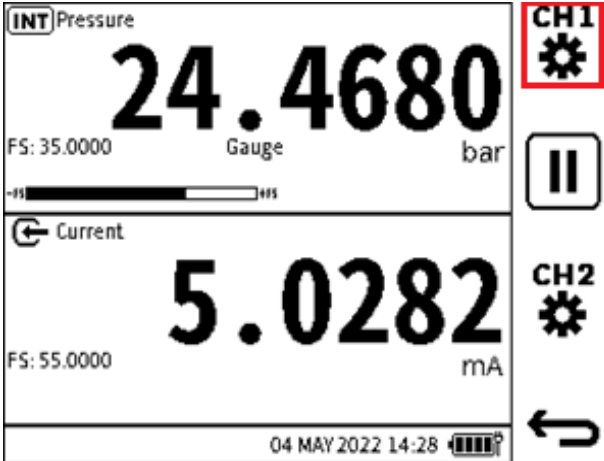
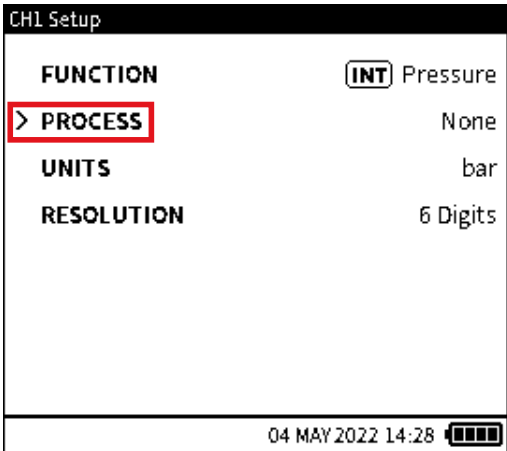
Note: **Tare** is only available for **Measure** functions with the exception of **Barometer** and **HART**.

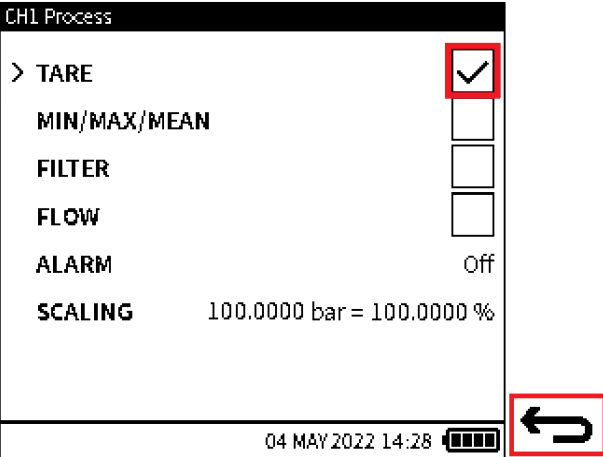
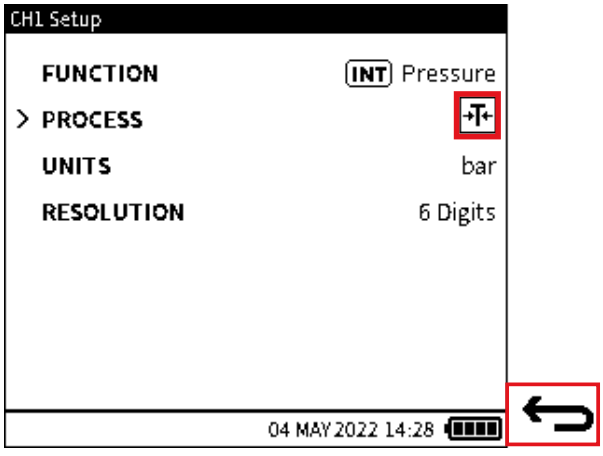
To enable the Tare function:.

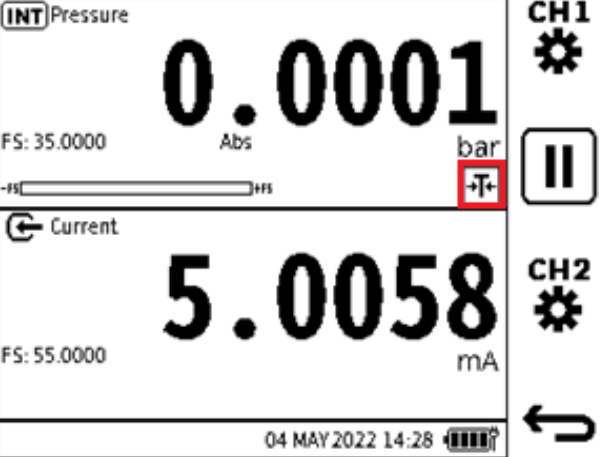
<p>Step 1</p>		<p>Select the desired channel.</p>
<p>Step 2</p>		<p>Select PROCESS.</p>

<p>Step 3</p>		<p>Select the TARE Checkbox. Tap on the Checkbox or use the Navigation Pad buttons to move to the TARE row and press the Pad's Enter button.</p> <p>Select the Back icon to go back to the Channel Setup screen.</p>
<p>Step 4</p>		<p>Check that the TARE  icon is in the Channel Setup screen, to confirm that Tare is enabled.</p> <p>Select the Back icon.</p>
<p>Step 5</p>		<p>Check that the TARE  icon appears in the relevant channel window and the channel reading is approximately zero.</p>



INFORMATION When Tare is disabled, the primary reading returns to displaying the true measured value.

Chapter 6. Calibrator Tasks

6.3.2 Min/Max/Mean





The **Min/Max/Mean** function provides the minimum, maximum and average of the primary reading from the time it is enabled. It is continuously updated as the reading values change and is displayed in addition to the live primary reading. When enabled, the **Min/Max/Mean** status icon is displayed. The relevant channel will need to be expanded to view the additional information (refer to “Maximize and Minimize Channel Window” on page 64 for how to expand the window).

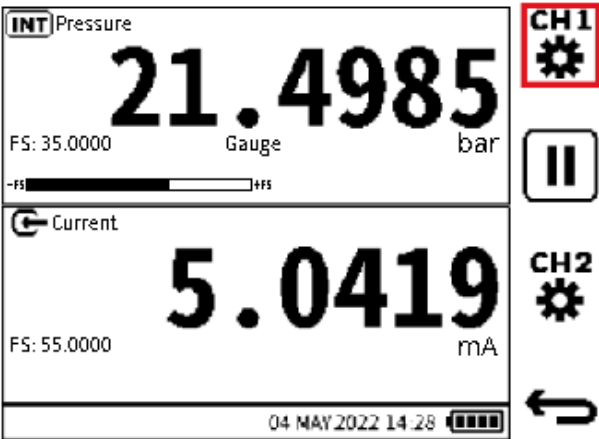
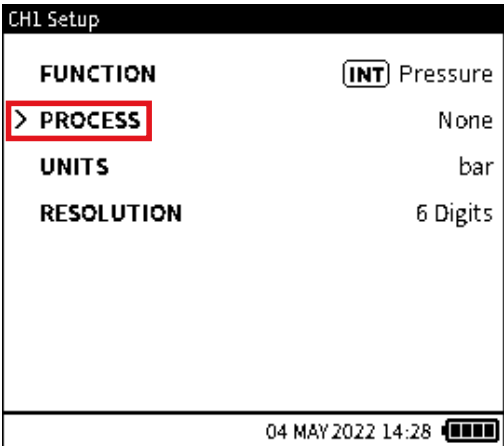

INFORMATION The Min/Max/Mean function is only applicable to Measure functions with the exception of HART.

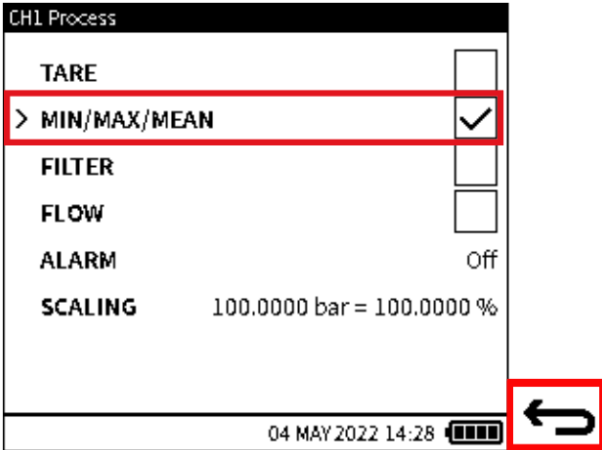
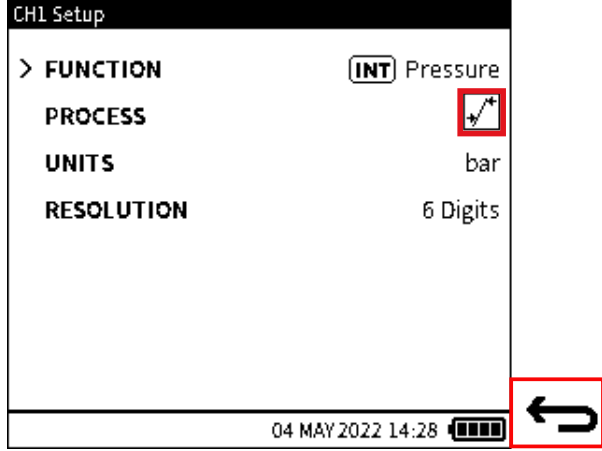
To enable the **Min/Max/Mean** function:

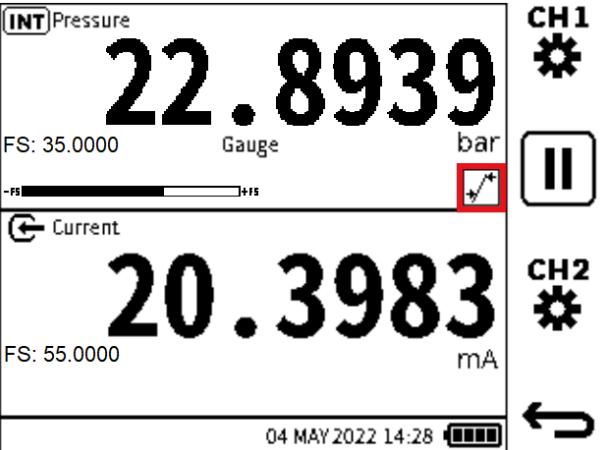
Step 1		Select the desired channel.
Step 2		Select PROCESS .

<p>Step 3</p>	 <p>The screenshot shows the 'CH1 Process' menu. The 'MIN/MAX/MEAN' option is highlighted with a red box and has a checkmark in its checkbox. A red box also highlights the back arrow icon at the bottom right of the screen.</p>	<p>Select the MIN/MAX/MEAN Checkbox and then select the Back icon.</p>
<p>Step 4</p>	 <p>The screenshot shows the 'CH1 Setup' menu. The 'PROCESS' option has a Min/Max/Mean icon (a square with a checkmark and a graph) next to it, which is highlighted with a red box. A red box also highlights the back arrow icon at the bottom right of the screen.</p>	<p>Check that Min/Max/Mean is enabled in the Channel Setup screen. (The Min/Max/Mean  icon will be displayed as the PROCESS option). Select the Back icon.</p>
<p>Step 5</p>	 <p>The screenshot shows the main display with two channels. The top channel is 'CH1 Pressure' with a value of 22.8939 bar. The 'PROCESS' option next to the value has a Min/Max/Mean icon, which is highlighted with a red box. The bottom channel is 'CH2 Current' with a value of 20.3983 mA. A red box also highlights the back arrow icon at the bottom right of the screen.</p>	<p>Check that the Min/Max/Mean  icon appears on the relevant channel window.</p> <p>INFORMATION To view Min/Max/Mean information maximize the relevant channel window. See “Maximize and Minimize Channel Window” on page 64 for details.</p>

Chapter 6. Calibrator Tasks

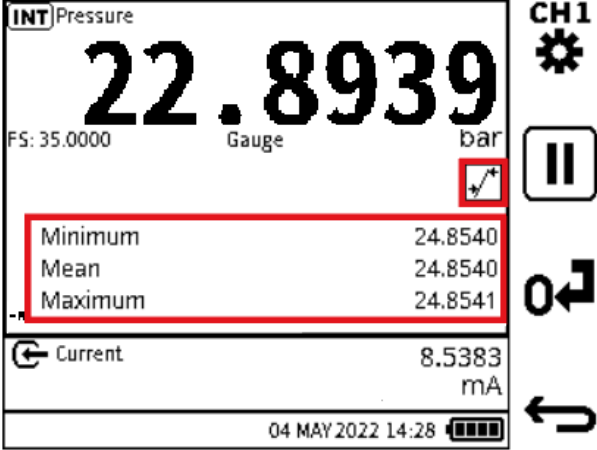
Step 6	 <p>The screenshot shows a digital pressure gauge interface. At the top, it displays 'INT Pressure' and a large reading of '22.8939'. Below this, it shows 'FS: 35.0000', 'Gauge', and 'bar'. A small table of statistics is highlighted with a red box:</p> <table border="1"><tr><td>Minimum</td><td>24.8540</td></tr><tr><td>Mean</td><td>24.8540</td></tr><tr><td>Maximum</td><td>24.8541</td></tr></table> <p>Below the statistics, it shows 'Current' as '8.5383 mA'. At the bottom, the date and time are '04 MAY 2022 14:28'. On the right side of the display, there are several icons: 'CH1', a gear icon, a pause icon, a refresh icon, and a back arrow icon.</p>	Minimum	24.8540	Mean	24.8540	Maximum	24.8541	<p>Min/Max/Mean information appears in the maximized channel window.</p>
Minimum	24.8540							
Mean	24.8540							
Maximum	24.8541							

6.3.3 Filter

The **Filter** function allows a low pass band filter to be applied to the channel readings. It is used to obtain a more stable measurement reading over a noisy signal.





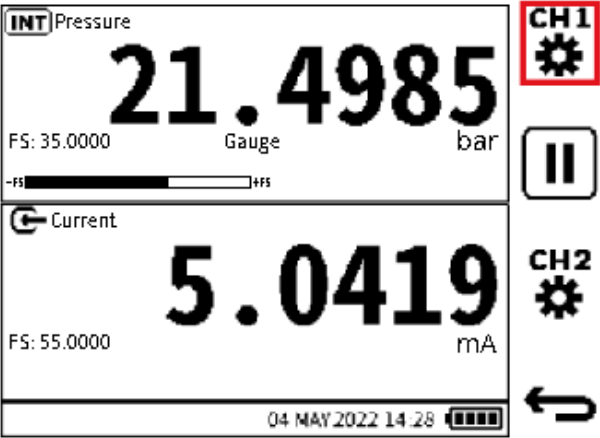
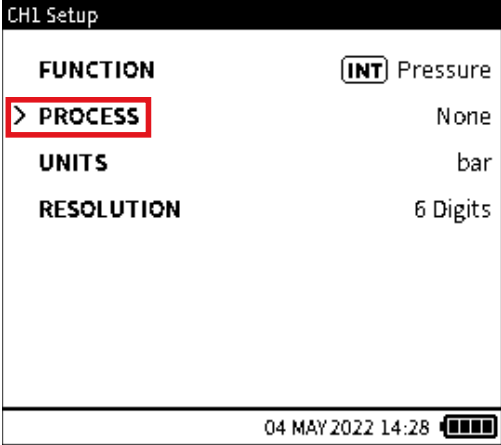

INFORMATION The Filter function can be applied on all functions except HART.

When the **Filter** process option is in enabled, the **Filter** status icon is displayed in the relevant channel.

To enable the **Filter** function:

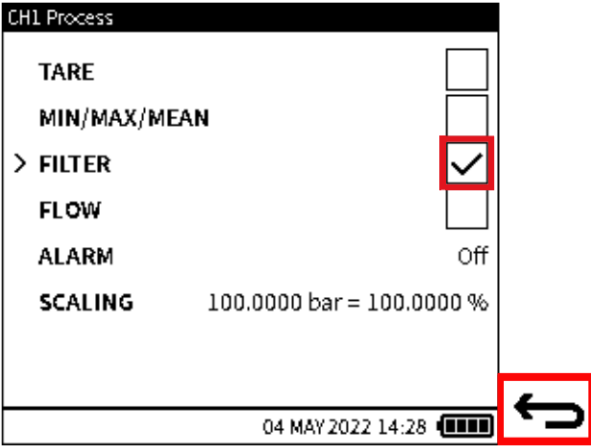
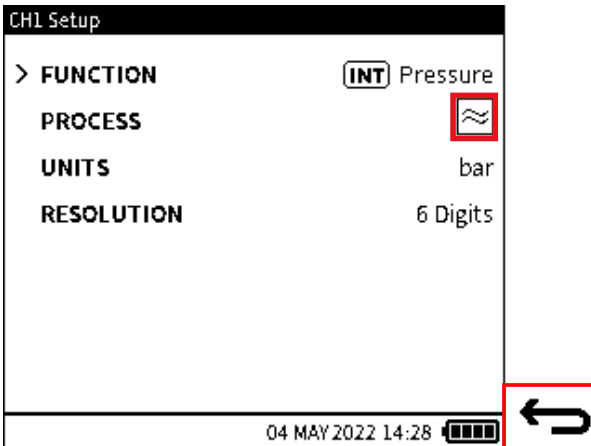
<p>Step 1</p>		<p>Select the desired channel.</p>
<p>Step 2</p>		<p>Select PROCESS.</p>

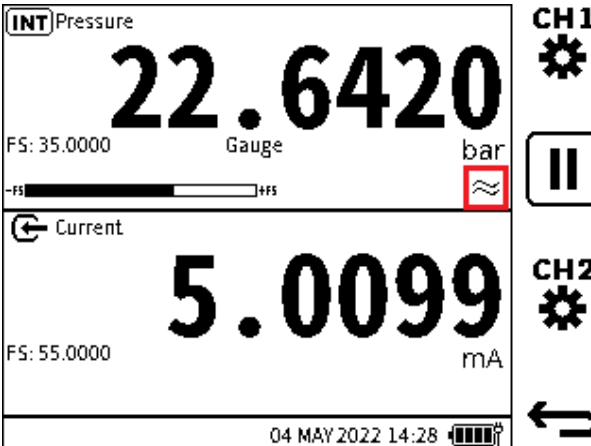
Chapter 6. Calibrator Tasks

<p>Step 3</p>		<p>Tap the FILTER Checkbox (put a tick mark in it) and then select the Back icon.</p>
<p>Step 4</p>		<p>The FILTER  icon should appear in the PROCESS row, to show that FILTER is enabled in the Channel Setup menu (as the PROCESS Option.) Select the Back icon to go back to the Calibration Main screen.</p>
<p>Step 5</p>		<p>Check that the FILTER  icon appears on the relevant channel window. (The FILTER icon will appear as the PROCESS option).</p>

6.3.4 Flow

The **Flow** function enables the square root of the measured pressure value to be displayed as the primary reading.



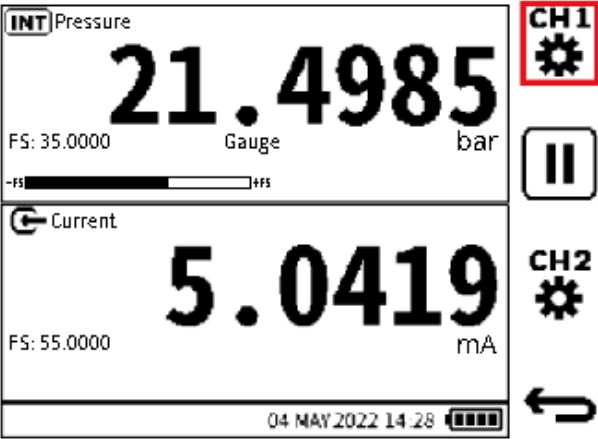
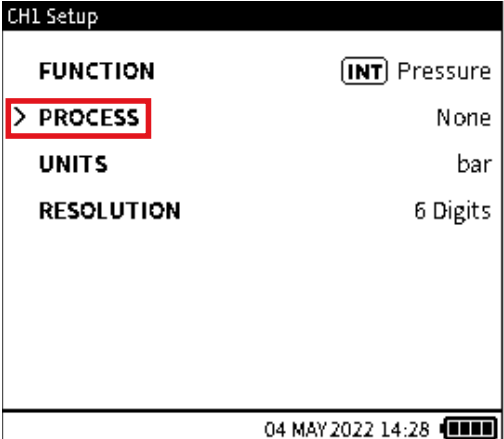

i **INFORMATION** The Flow process option is only supported by pressure functions i.e. Internal Pressure, External Pressure, Sum and Difference.

When enabled the **Flow** status icon  appears.

To enable the Flow function:

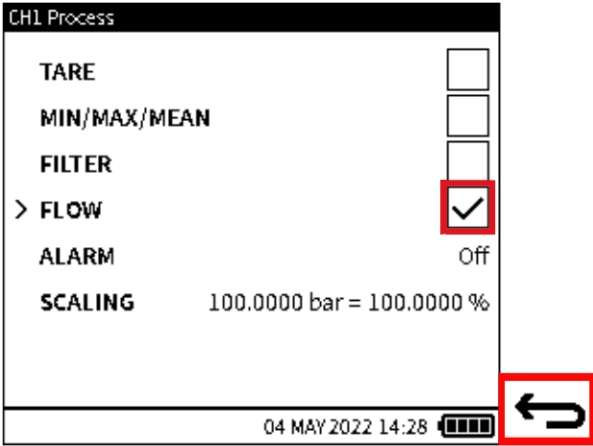
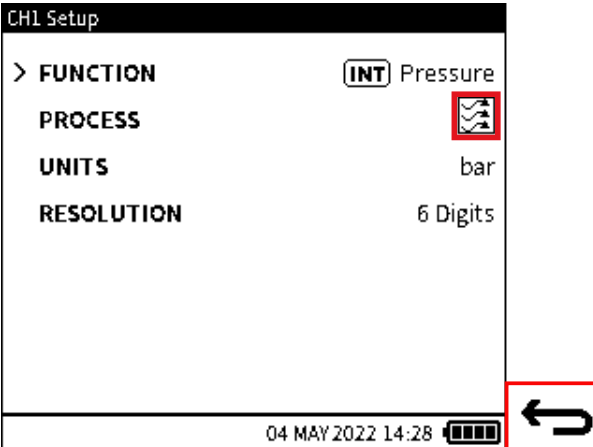
<p>Step 1</p>		<p>Select the desired channel.</p>
<p>Step 2</p>		<p>Select PROCESS.</p>

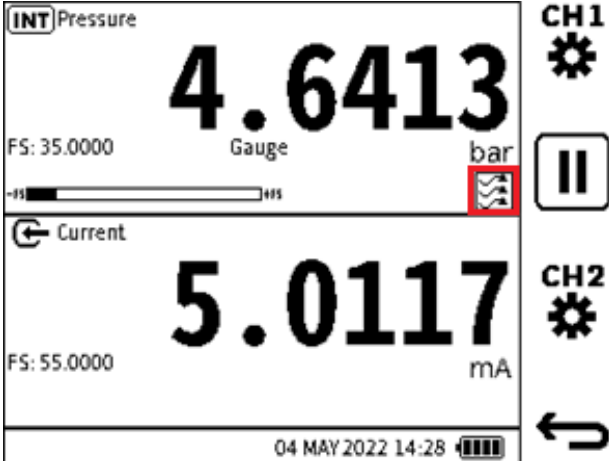
Chapter 6. Calibrator Tasks

<p>Step 3</p>		<p>Tap the FLOW Checkbox (put a tick mark in it) and then select the Back icon.</p>
<p>Step 4</p>		<p>The FLOW  icon should appear in the PROCESS row, to show that FLOW is enabled in the Channel Setup menu (as the PROCESS Option.) Select the Back icon to go back to the Calibration Main screen.</p>
<p>Step 5</p>		<p>Check that the FLOW  icon appears in the relevant channel window.</p>

6.3.5 Alarm

This process option provides a visual indication of when a user-set alarm limit is exceeded.





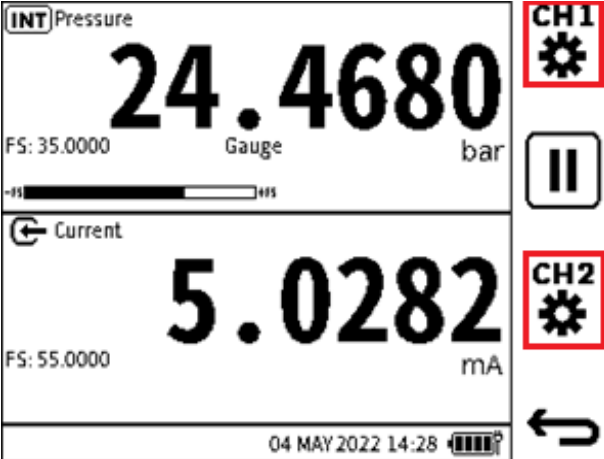
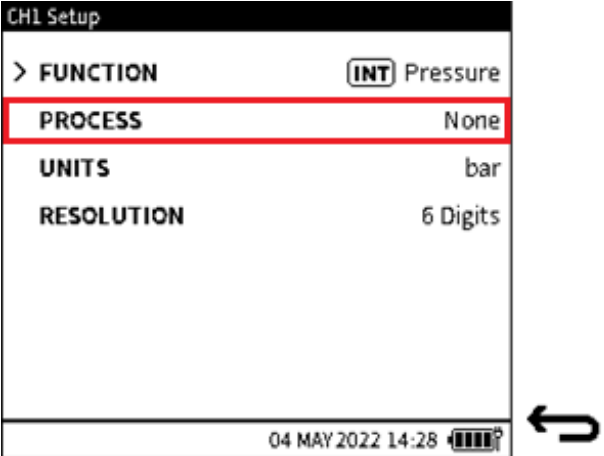

INFORMATION The user Alarm option is available with all Measure functions except for Barometer and HART.

To enable and configure the user Alarm option:

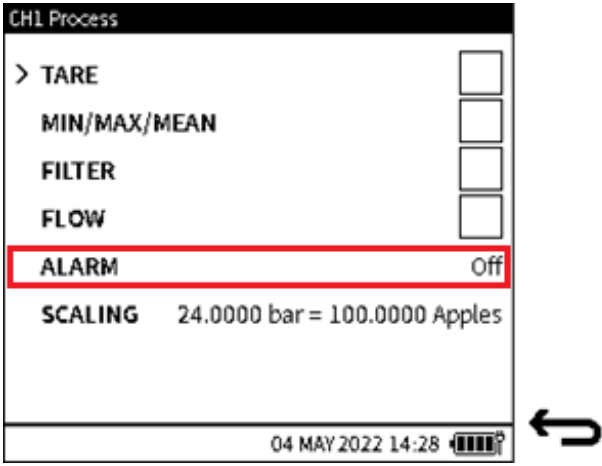
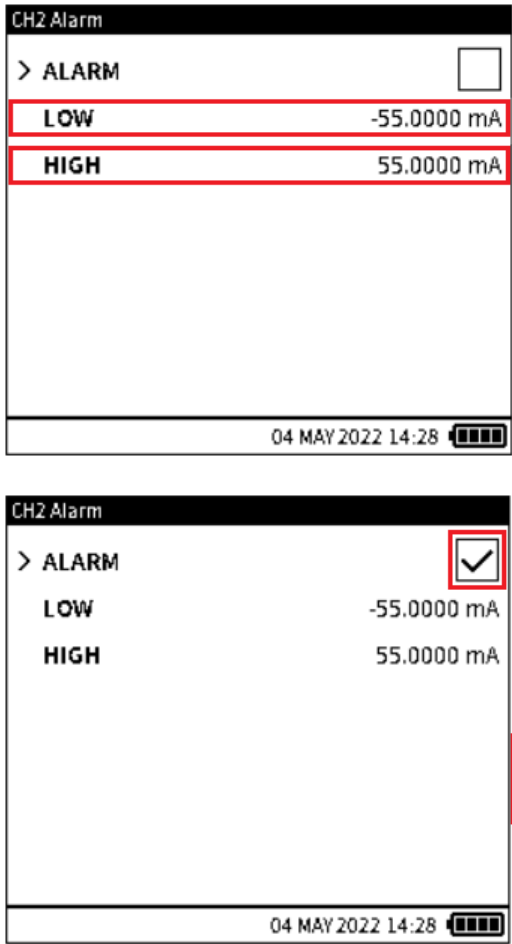
Step 1		Select the CH1 or CH2 icon as the desired channel.
Step 2		Select PROCESS .

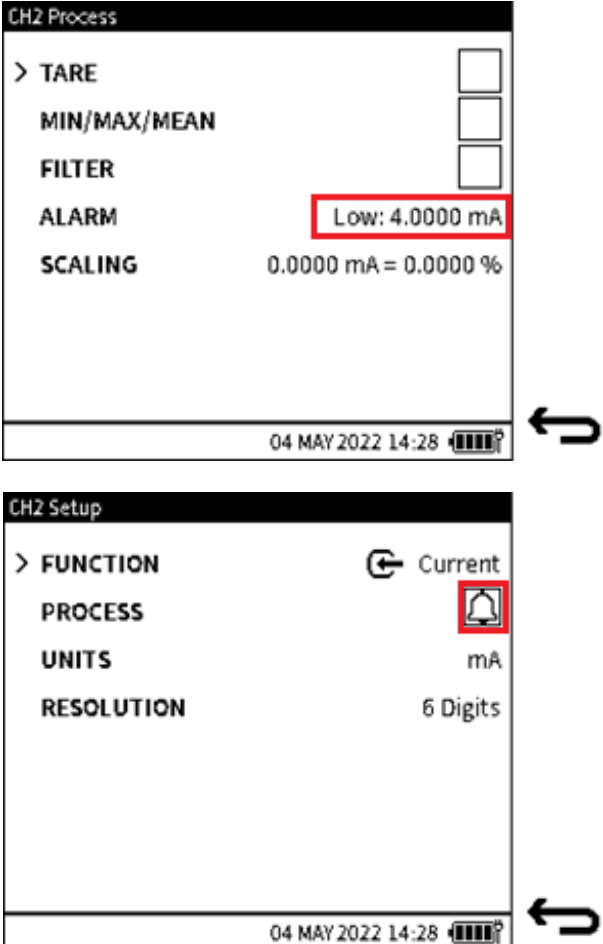
Chapter 6. Calibrator Tasks

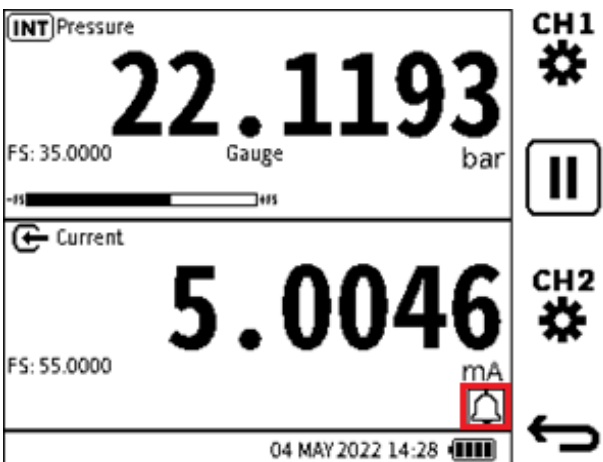
<p>Step 3</p>	 <p>The screenshot shows the 'CH1 Process' screen. It lists several options: TARE, MIN/MAX/MEAN, FILTER, FLOW, ALARM (highlighted with a red box), and SCALING. The ALARM status is 'Off'. A red arrow points to the ALARM option.</p>	<p>Tap the ALARM area or use the Navigation Pad buttons to select it. The Alarm screen appears.</p>
<p>Step 4</p>	 <p>The first screenshot shows the 'CH2 Alarm' screen with 'LOW' (-55.0000 mA) and 'HIGH' (55.0000 mA) options highlighted. A red checkmark icon is next to it. The second screenshot shows the same screen with the 'ALARM' checkbox checked. A red checkmark icon is next to it.</p>	<p>Use the procedures given below to set the LOW and HIGH values for alarm activation.</p> <p>Use the Navigation button to move to the LOW option, press the Navigation Enter button to show an onscreen keypad. Use the keypad to enter the value for the lower end of normal range condition. Select the Tick softkey to confirm the value. Note: By default, the LOW (zero or negative full-scale) range value of the selected measure function is populated.</p> <p>Select the HIGH option and enter the value for the highest end of normal range condition. Select the Tick softkey to confirm the value. Note: by default, the HIGH (positive full-scale) range value of the selected measure function is populated.</p> <p>Use the Navigation Pad to select the ALARM row. Press the Enter key in the pad to insert a tick into its checkbox or tap in the checkbox. Press the Tick softkey to confirm the alarm settings and return to the PROCESS options screen. Note: To disable the Alarm, select the Alarm Checkbox to remove the Tick mark.</p>

<p>Step 5</p>		<p>The values displayed in the ALARM row switch between the LOW and HIGH values. Press the Back softkey to return to the Channel Setup screen.</p> <p>The ALARM  icon appears, to show that the PROCESS option is enabled.</p>
<p>Step 6</p>		<p>When the Alarm is enabled, the ALARM  icon appears in the relevant channel window.</p> <p>If the measured value falls outside the normal range condition, the alarm will be triggered. An alarm condition is indicated by both the ALARM  icon and the measured reading flashing within the relevant channel. When the measured value falls within the normal specified range condition, the icon and measured value will stop flashing.</p>

Chapter 6. Calibrator Tasks

6.3.6 Scaling

This process option provides a method of configuring custom measurement units, using the original units of the Functions. Scaling provides two pairs of values that define the linear relationship between the original measurement unit and the configured custom unit.



INFORMATION The Scaling option is available with all measure and source functions except for Observed and HART.

There are two methods to activate and configure the Scaling option.

6.3.6.1 First Scaling Method

<p>Step 1</p>		<p>Select the ^{CH1} or ^{CH2} icon for the desired channel.</p>
<p>Step 2</p>		<p>Select PROCESS.</p>

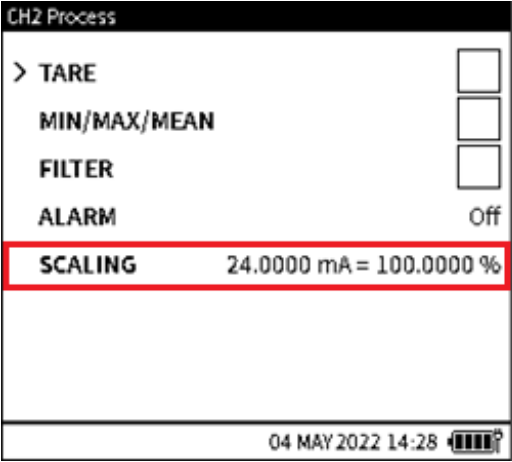
<p>Step 3</p>	 <p>The screenshot shows a menu titled "CH2 Process" with the following options: TARE, MIN/MAX/MEAN, FILTER, ALARM (Off), and SCALING (24.0000 mA = 100.0000 %). The SCALING option is highlighted with a red border. A black arrow points to the right from the bottom right corner of the screenshot.</p>	<p>Tap the SCALING area or use the Navigation pad buttons to select it. The Scaling screen appears for the selected channel.</p>
---------------	--	--

Step 4

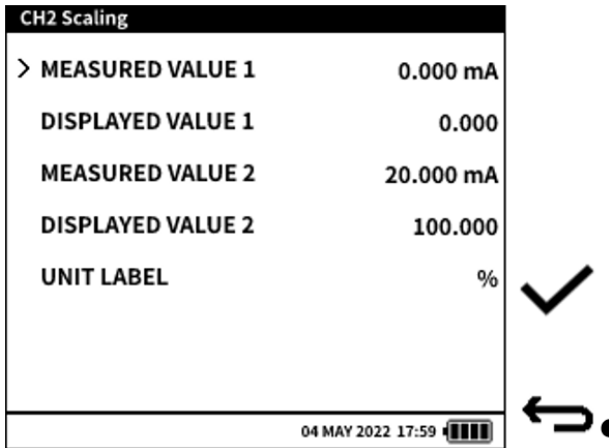

Use the keys on the Navigation Pad to move to the required row and press the **Enter** key to show a screen keypad. Tap or use the Navigation keys (press the **Enter** key to enter each number) to select each keypad number. To confirm the complete number press the **Tick** softkey.

MEASURED VALUE 1: a minimum value within the measurement/source range of the selected function. By default, this is populated as the zero or negative full-scale value of the measurement/source function.

DISPLAYED VALUE 1: a minimum value equivalent to the minimum measured value expressed as the custom unit. By default, the value populated is 0(%).

MEASURED VALUE 2: a maximum value within the measurement/source range of the selected function. By default, this is populated as the positive full-scale value of the measurement/source function.

DISPLAYED VALUE 2: a maximum value equivalent to the maximum measured value expressed as the custom unit. By default, the value populated is 100(%).



UNIT LABEL: this is a free text field where the custom unit can be named. It is limited to a maximum of 6 characters. The default custom unit label is %.

The custom label uses this relationship formula:

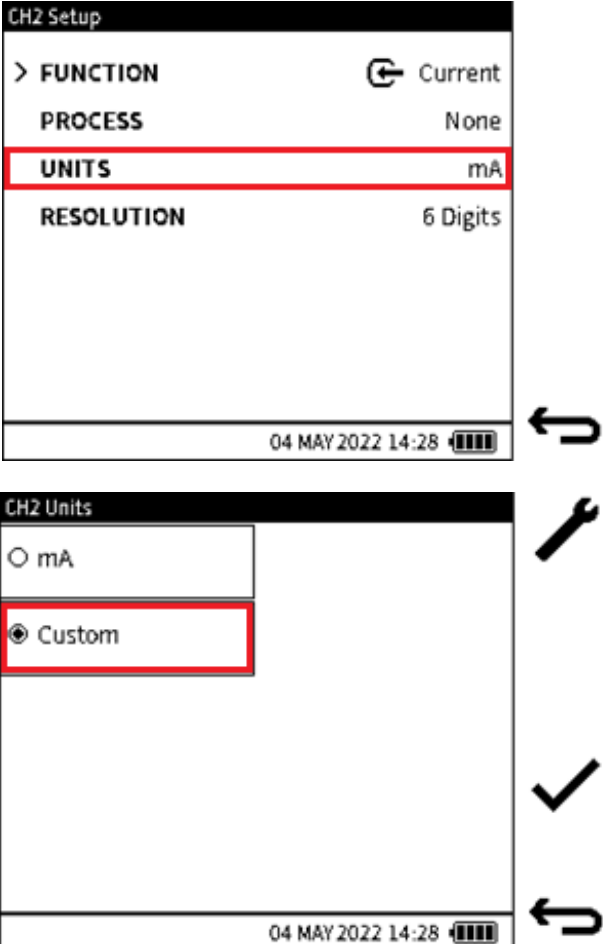
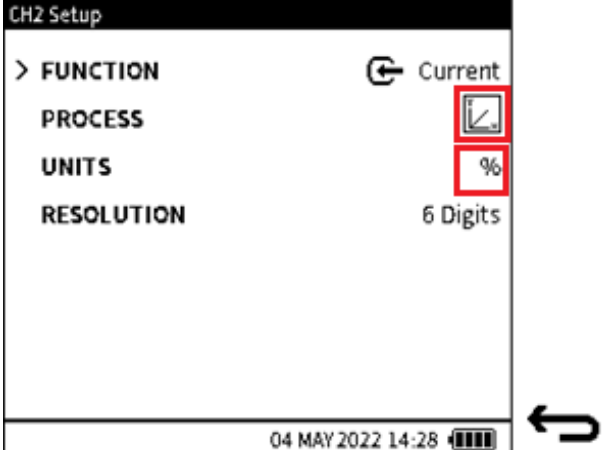

$$Displayed\ value_x = \frac{Displayed\ Value_2 - Displayed\ Value_1}{Measured\ Value_2 - Measured\ Value_1} \times Measured\ Value_x$$

Note: The measured values are in the original units e.g. mA and displayed values are in the custom label units e.g. %.

When the scaling parameters have been configured, select the **Tick** softkey to confirm the changes and return to the **PROCESS** screen. The updated **Channel Scaling** parameters appear in the **Scaling** fields.

<p>Step 5</p>		<p>To enable or use the custom units, press the Back softkey to go to the Channel Setup screen. Select UNITS. Move down the UNIT options and select Custom. Select the Tick softkey to confirm the selection and return to the Channel Setup screen.</p>
<p>Step 6</p>		<p>The Scaling  icon will appear in the PROCESS field and the custom unit label will be displayed in the UNITS field. Select the Back softkey to return to the Channel Setup screen.</p>

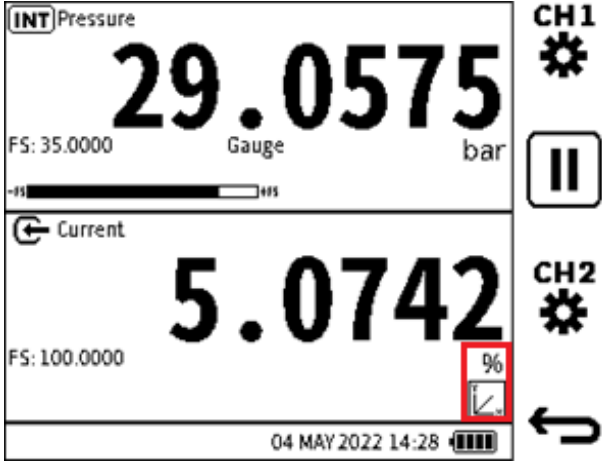

Chapter 6. Calibrator Tasks

Step 7		<p>The Scaling  icon will be in the relevant channel window and the UNITS field will show the configured custom label. In addition, the full-scale value will be expressed as its equivalent in the custom unit. Check that the minimum and maximum displayed values correspond with the minimum and maximum measured values</p>
--------	---	---

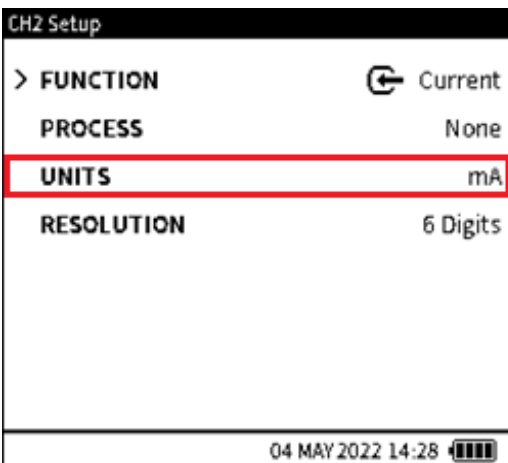
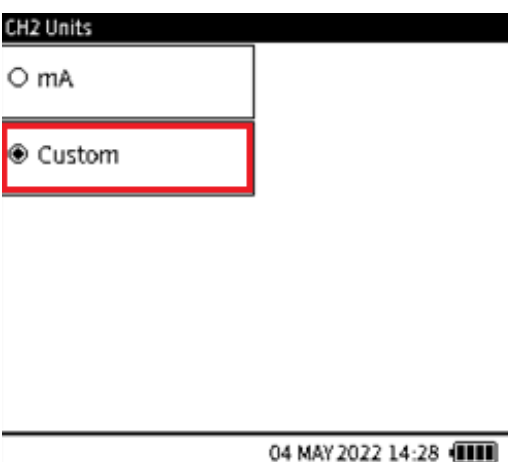
6.3.6.2 Second Scaling Method

Step 1	 <p>The screenshot shows the 'CH2 Setup' screen with the following fields: FUNCTION (Current), PROCESS (None), UNITS (mA), and RESOLUTION (6 Digits). The 'UNITS' field is highlighted with a red border. A back arrow icon is located to the right of the screen, and the status bar at the bottom shows the date and time as '04 MAY 2022 14:28'.</p>	Select the UNITS field in the Calibrator screen (Refer to steps 1 to 4 in Section 6.3.6.1).
Step 2	 <p>The screenshot shows the 'CH2 Units' screen with two radio button options: 'mA' and 'Custom'. The 'Custom' option is selected and highlighted with a red border. A wrench icon is located to the right of the screen, and a checkmark icon is located below it. The status bar at the bottom shows the date and time as '04 MAY 2022 14:28'.</p>	Select the Custom option.

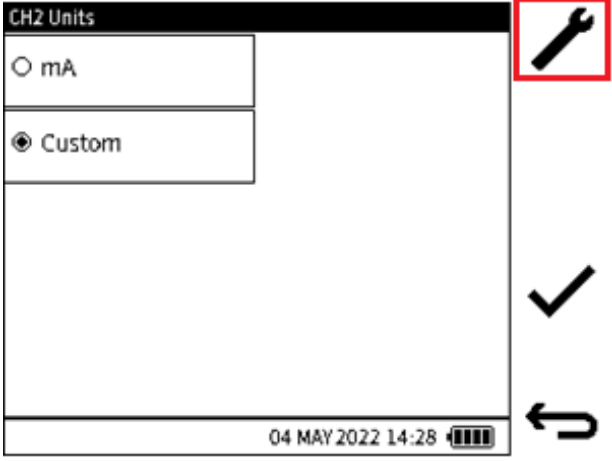
Chapter 6. Calibrator Tasks

Step 3		<p>Select the Setup  softkey to view and/or change the Scaling parameters which configure the custom unit. For details on how to configure the parameters, see Section 6.3.6.1 for Method 1)</p>
--------	---	---

7. Utilities

Pressure functions provide utilities or tests, which are:

- Leak Test
- Switch Test
- TX Simulator
- Relief Valve Test.

The **Tasks** menu gives access to these utilities. Only pressure measure functions are supported with a utility function.

When the Leak Test, Switch Test and Relief Valve Tests are done, there is the option to save the test results in the DPI 610E. These result files are in the CSV format and can be viewed when transferred to a PC (See Section 5.3.1 on page 55). As a result, the Data logging application does not support these tests.

The Transmitter Simulation (TX SIM) utility is supported by Data logging.

7.1 Leak Test



Leak Testing is usually done to make sure that the pressurised equipment or system and its associated components do not leak. When a Device Under Test (DUT) is connected to the DPI 610E pressure test port either directly or using hoses and auxiliary connections, it is good practice to check for any possible leaks before commencing calibration or any other tests.

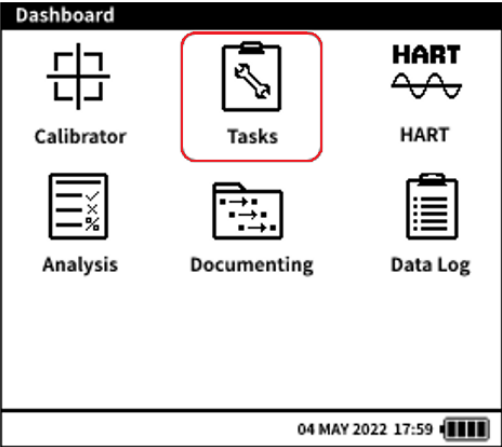

In a Leak Test, pressure (or vacuum) is applied to the system (typically not exceeding 10% of the sensor working pressure) and any change in this pressure is recorded over the duration of the test.

To configure and run a Leak Test:

Step 1		Tap on the Tasks icon on the Dashboard to select the menu.
--------	---	---

Chapter 7. Utilities

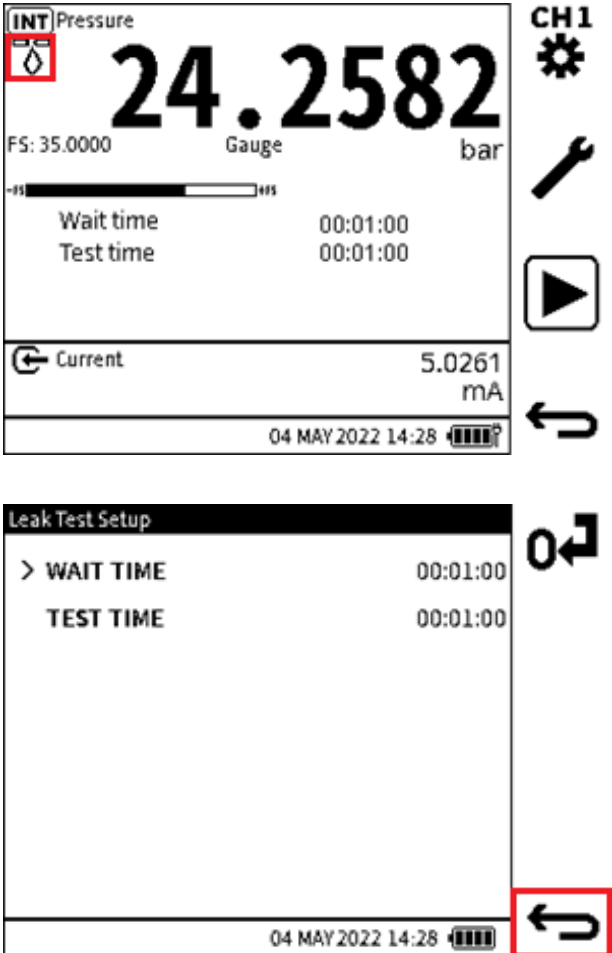
Step 2	<table border="1"><thead><tr><th colspan="2">Tasks</th></tr></thead><tbody><tr><td>P - I</td><td>> Leak Test</td></tr><tr><td>P - P</td><td>Switch Test</td></tr><tr><td>P - V</td><td>Tx Sim</td></tr><tr><td>I - P</td><td>Relief Valve</td></tr><tr><td>P-Display</td><td></td></tr></tbody></table>	Tasks		P - I	> Leak Test	P - P	Switch Test	P - V	Tx Sim	I - P	Relief Valve	P-Display		<p>From the Tasks menu, select Leak Test from the Task list. Tap the Leak Test option again if using the touchscreen or press the Navigation pad OK  button to launch the Leak Test utility.</p> <p>Note: If no compatible function is configured on CH1, the Internal Pressure function will be used automatically to run the Leak Test.</p>
	Tasks													
	P - I	> Leak Test												
	P - P	Switch Test												
	P - V	Tx Sim												
	I - P	Relief Valve												
P-Display														
														
														

<p>Step 3</p>		<p>On the Leak test screen, CH1 will automatically be maximized to show the relevant test details. The Leak  icon is displayed below the Function name field. The WAIT TIME and TEST TIME are the two parameters for setting up the Leak test and these are displayed in the channel window. They use the HH:MM:SS format.</p> <p>To enter a value into either of the parameters, tap the WAIT TIME or TEST TIME text to show an onscreen keypad. Use this keypad to enter the required value.</p> <p>WAIT TIME- Before starting a Leak test a period of time may be required to allow the pressurized system to settle before the actual test is started. This time is referred to as WAIT TIME on the DPI 610E and the default WAIT TIME is 1 minute (00:01:00). This time value can be changed to any value between 0 seconds (00:00:00) up to 60 minutes (01:00:00).</p> <p>TEST TIME - This is the period over which the DPI 610E is testing for change in pressure i.e., leaks. The default TEST TIME is 1 minute (00:01:00) and this time value can be changed to any value between 1 second (00:00:01) and 480 minutes (08:00:00). These time settings can be quickly accessed if using the touchscreen, by tapping the relevant fields on the channel window. Another way to access these settings is by selecting the Setup softkey.</p> <p>The Leak Test Setup screen will provide the options for both the WAIT TIME and the TEST TIME. Press the Back softkey to return to the Leak Test screen.</p>
<p>Step 4</p>	<p>After the Leak Test times have been set, pressurize the system to the desired pressure using the DPI 610E pump.</p>	

Chapter 7. Utilities

Step 5

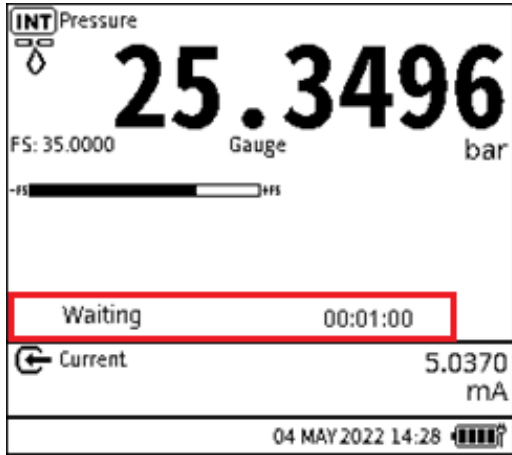

Select the **PLAY** softkey to begin the task. (This icon will change to a **STOP** icon after selection).

Note: the displayed **WAIT TIME** and **TEST TIME** settings will be cleared.

Note: If a **WAIT TIME** has been set, a “Waiting” countdown begins from the **WAIT TIME** value down to zero. This potentially gives enough time for the pressure to stabilize.

After the **WAIT** time has elapsed, the test begins. The Start pressure value is recorded on the screen at the start of the test. A “Testing” countdown begins from the **TEST TIME** value down to zero.



When the **TEST TIME** has elapsed, the **End** pressure value is also recorded and the **Leak Rate** per minute is calculated and displayed as the Leak test result.

Step 6



INT Pressure
32.2258
 FS: 35.0000 Abs bar
 Start 32.2098
 End 32.2178
 Leak Rate (/min) -0.0080
 Current 5.1058 mA
 04 MAY 2022 14:28



LEAK TEST
 FILENAME **LEAK**
 Q W E R T Y U I O P
 A S D F G H J K L ?123
 Z X C V B N M
 04 MAY 2022 14:28

If required, the test result can be saved by selecting the **Save**  softkey before exiting the test screen. A keypad appears on the screen. Use this keypad if you want to enter a new name for the results file.

The default result filename will be the DPI 610E date and time stamp. Select the **Tick**  softkey to confirm the new result filename and complete the save process.

Note: Result files are stored within the internal memory of the DPI 610E. See Chapter 14 (File System). Only the list of test result files can be viewed on the device. Details of the files can only be accessed when the files are opened on a PC (See Section 9.6.2 on page 168).

7.2 Switch Test

The DPI 610E can test pressure switches or pressure devices with switch contacts.

Pressure switches open or close an electrical circuit when a configured setpoint pressure level is reached and/or exceeded.



Pressure switches commonly have two types of contact which are: normally open or normally closed. When a pressure switch is normally open, it means that the state of the switch contacts, when pressurised within normal operating limits, is Open. When the pre-set setpoint pressure is reached, the micro-switch is triggered (Actuation) and the contacts change state from open to closed. When the pressure returns within normal operating limits, the switch contacts are reset (De-actuation) i.e. changes back to the normal open state.

For a normally closed switch the reverse is the case. At the switch point (Actuation), the state changes from Closed to Open and at the reset point (De-actuation), it returns to the closed state.



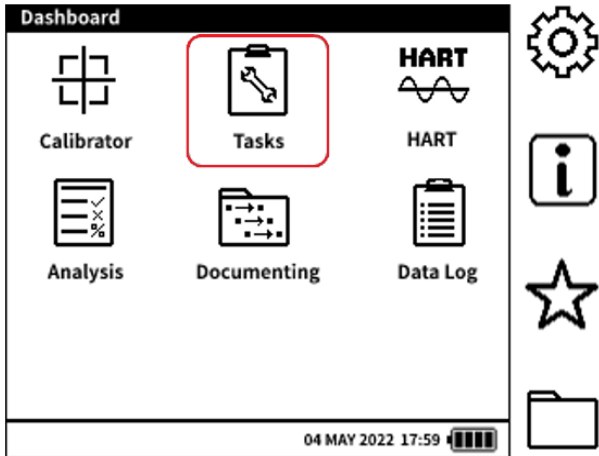
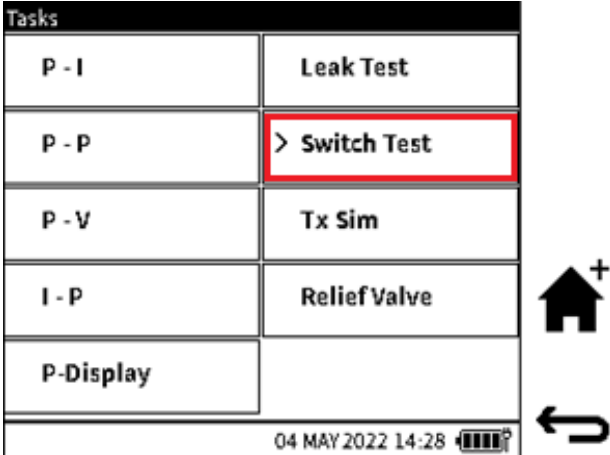

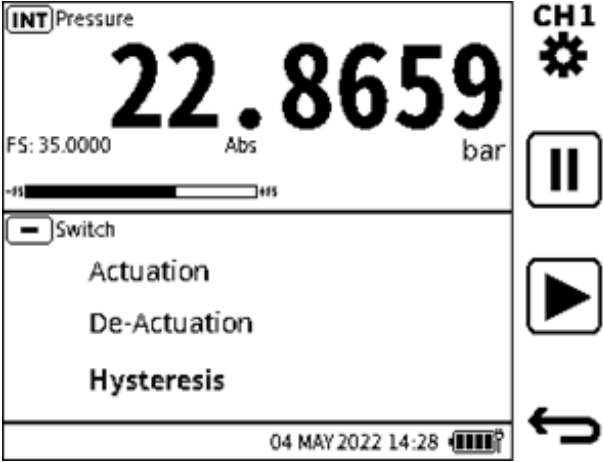
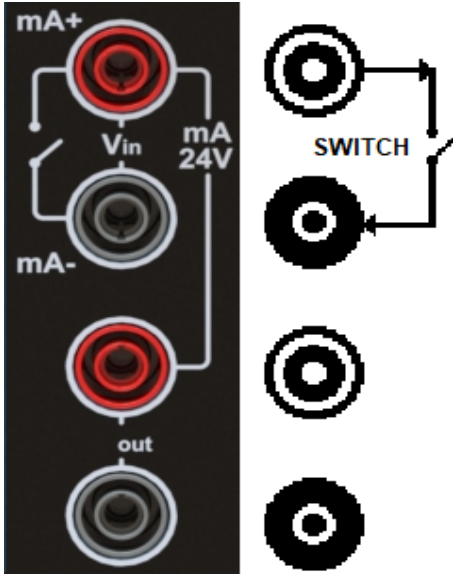
The difference between the switch point and reset point is called Hysteresis.

To configure and do a Switch test:

<p>Step 1</p>		<p>Tap on the Tasks icon on the Dashboard to select the menu.</p>
<p>Step 2</p>		<p>Tap the Switch Test two times if using the touchscreen or press the OK button to launch the utility.</p>

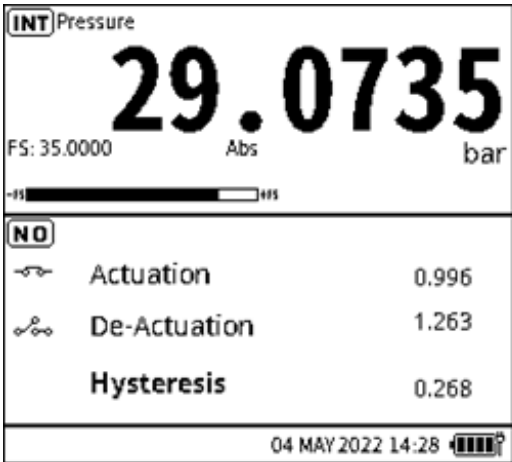
<p>Step 2 Cont'd</p>		<p>The Calibrator screen will be configured with the Switch Test data. The Pressure related function is configured on CH1 while the Switch Test data are in the CH2 window.</p> <p>Note: if no compatible function is configured on CH1, the Internal Pressure function will be used automatically to run the Switch Test.</p>
<p>Step 3</p>	<p>Open the DPI 610E pressure line by loosening the pressure release knob. Check that the pressure indicates a value around zero if using a gauge sensor or around 1 bar if using an absolute sensor.</p>	
<p>Step 4</p>	<p>Connect the pressure switch or device to the test port securely.</p>	
<p>Step 5</p>	<p>Connect test leads from the pressure switch contacts to the \pm mA/Vin ports on the DPI 610E as shown in the connection diagram below.</p> 	
<p>Step 6</p>	<p>Select the PLAY  softkey to begin the Switch Test. (This icon will change to a STOP  icon after selection). At this point the normal state is detected i.e. If open, it is identified as Normally open (NO) in the test window. Vice versa, if a closed circuit is detected, the switch will be identified as Normally closed (NC) for the duration of the test.</p>	

Chapter 7. Utilities

Step 7	Close the pressure line by fully closing the pressure release knob. Check there are no leaks.	
Step 8	 	<p>Slowly start to pressurize the system. If the trip or actuation point is known and it is safe to do so, the pump may be used to quickly ramp up the pressure close to the setpoint and then the volume adjuster can be used to slowly increase the pressure closer to the setpoint.</p> <p>Once the switch is actuated, the actuation pressure is recorded in the switch test channel window. The state icon for the actuation is also displayed i.e. icon of a switch open or a switch closed.</p> <p>Increase the pressure a little more and allow to settle.</p> <p>Gradually start to reduce the pressure using the volume adjuster. At the switch reset (De-actuation) point, the pressure is recorded and the switch state icon at this point is displayed.</p> <p>The test is concluded with the Hysteresis value calculated and displayed. This completes the switch test cycle.</p> <p>If required, the test result can be saved by selecting the Save  softkey before exiting the test screen.</p> <p>A keypad appears on the screen. Use this keypad if you want to enter a new name for the results file.</p> <p>If the results are saved, the test details will be cleared and the test will be restarted.</p> <p>If the results are not saved, a new switch test cycle can be set up ready to be run. To do this, carefully vent the system (open the pressure release knob) and then select the Restart  softkey.</p>





Note: Result files are stored within the internal memory of the DPI 610E. See Chapter 14 (File System). Only the list of test result files can be viewed on the device. Details of the files can only be accessed when the files are opened on a PC (See Section 9.6.2 on page 168).

7.3 TX (Transmitter Simulation) Simulator

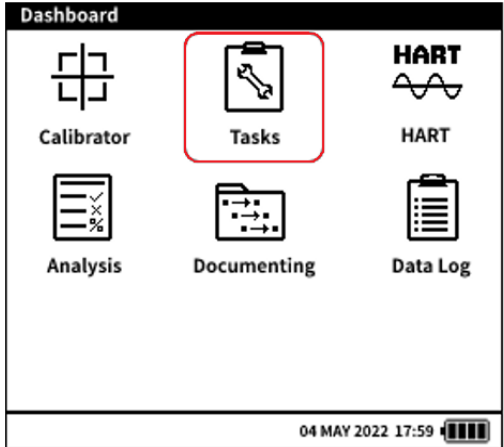
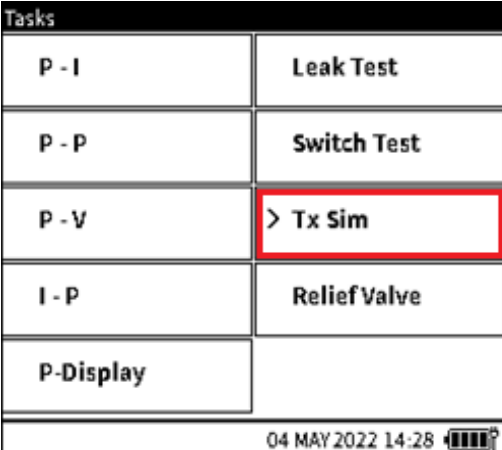
The DPI 610E provides a current output (current source) which is proportional to the pressure measured and indicated by the DPI 610E. This utility is normally used by the DPI 610E to simulate a pressure transmitter and it configured by specifying the transfer function parameters of the current output transmitter to be simulated.

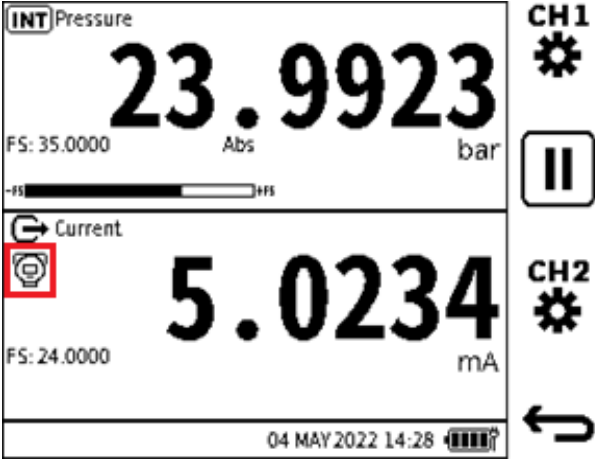

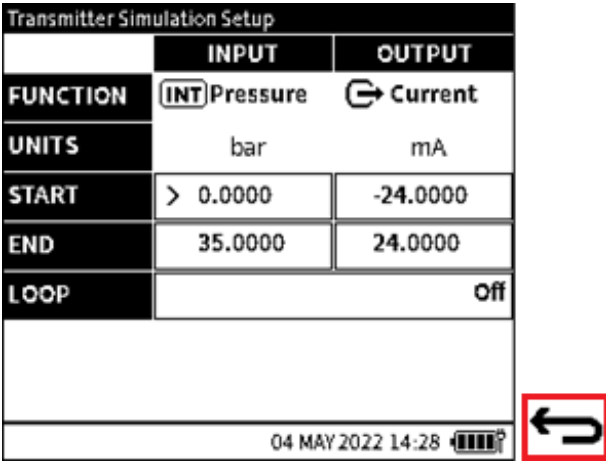
To configure and run the Transmitter Simulation mode:

<p>Step 1</p>		<p>Tap on the Tasks icon on the Dashboard to select the menu.</p>
<p>Step 2</p>		<p>From the Tasks menu, select Tx Sim from the Task list. Tap the Tx Sim option again if using the touchscreen or press the Navigation pad OK button to start the utility.</p>



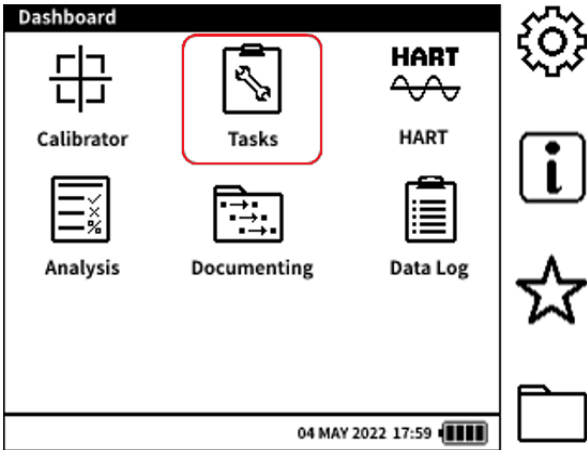
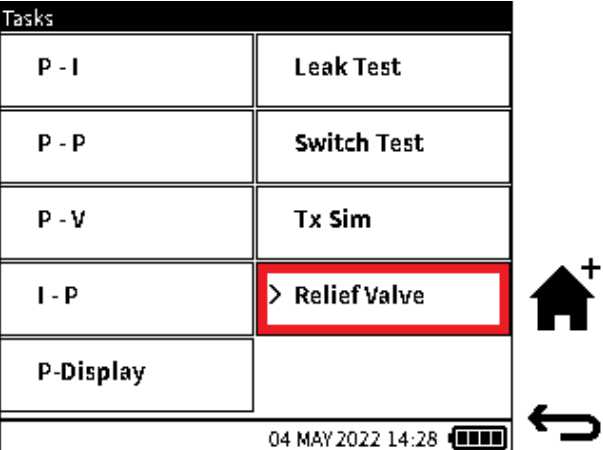
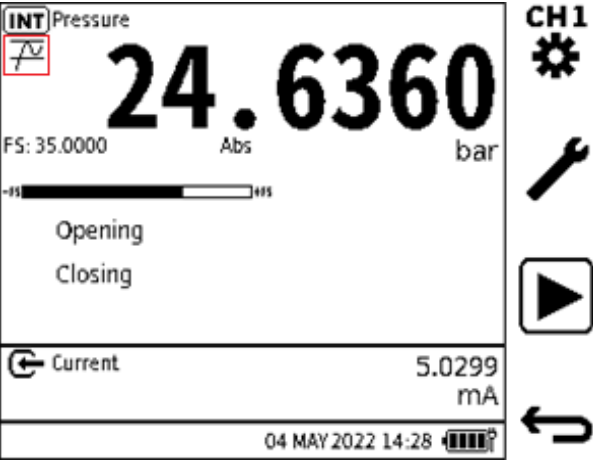

<p>Step 3</p>		<p>The Calibrator screen will be configured with the transmitter simulation details. CH1 will be configured with the internal pressure function while CH2 will be configured with Current source in simulation mode. The TX Sim  icon will be displayed within the CH2 window under the Function name field. Note: In TX Sim mode, the current output is automatically determined, and source based on the transfer function characteristic configured.</p>
<p>Step 4</p>		<p>To configure the simulated transmitter: Tap in the CH2 area to maximize the CH2 window and select the Setup  softkey. Select and edit the START and END values of the Input channel i.e. the Pressure channel. Default values are the zero (or Negative full-scale) and the Positive full-scale of the internal pressure sensor respectively. Select and edit the Start and End values of the OUTPUT channel i.e. the current source channel. Default values are 0 and 24 mA. There is also the option for the DPI 610E to provide power i.e. 10V or 24V. The default setting is Off (no power provided by the DPI 610E). Press the Back  softkey.</p>

7.4 Relief Valve Test

This mode is used when testing vacuum relief valves, which open to prevent an excessive internal vacuum pressure and close when the system returns to normal operating pressure conditions. Relief Valve Test result files are stored within the internal memory of the DPI 610E. See Chapter 14 (File System). Only the list of test result files can be viewed on the device. Details of the files can only be accessed when the files are opened on a PC (See Section 9.6.2 on page 168). To configure and run a Relief Valve test:

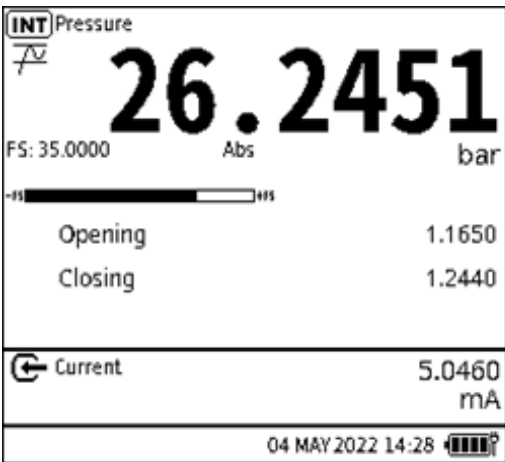
<p>Step 1</p>		<p>Tap on the Tasks icon on the Dashboard to select the menu.</p>
<p>Step 2</p>		<p>From the Tasks menu, select Relief Valve from the Task list. Tap the Relief Valve option again if using the touchscreen or press the Navigation pad OK button to launch the utility.</p>
<p>Step 3</p>		<p>The Calibrator screen will be configured with the Relief Valve Test details. The CH1 window will be automatically maximized to display the test details. Note: the default Relief Valve mode is Rising. To change the Relief Valve type, select the Setup  softkey and select the required type. Select the Tick softkey to confirm and return to the Calibrator screen. The relevant Relief Valve type icon will be displayed in the channel window under the Function name field.</p>
<p>Step 4</p>	<p>Vent the pressure on the DPI 610E by opening the pressure release knob fully.</p>	

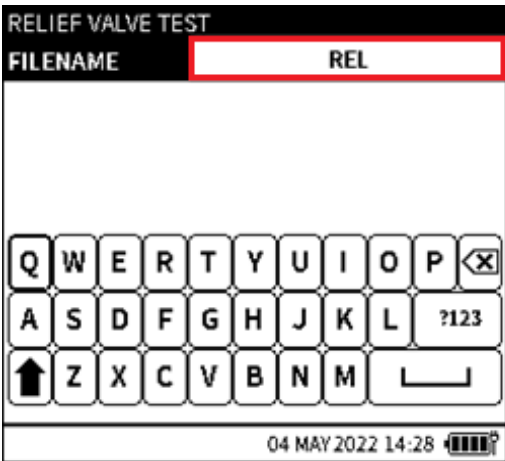
Chapter 7. Utilities

Step 5	Connect the Device Under Test (DUT) securely to the pressure test port of the DPI 610E. Refer to “Attach Device Under Test” on page 28 for instructions.
Step 6	Seal the pressure system by closing the pressure release valve securely. For location of this valve refer to “Parts” on page 19.
Step 7	<p>Select the PLAY  softkey to start the Relief Valve test. The display will start to show the Opening and Closing values.</p> <p>If in Rising Relief Valve mode, the Opening pressure is continually updated as the maximum pressure detected once the test has started. The closing pressure is continually updated as the minimum pressure detected each time a new maximum pressure is recorded.</p> <p>If in Falling Relief Valve mode, the reverse is the case i.e. the Opening pressure is continually updated as the minimum pressure detected once the test has started. The Closing pressure is continually updated as the maximum pressure detected each time a new minimum pressure is recorded.</p> <p>Assuming the Rising Relief Valve mode is used, gradually increase the pressure using the pump or the volume adjuster towards the Relief valve setpoint or blow down pressure. Around the setpoint mark, observe the pressure reading when it stops increasing with any further generated pressure. The Opening pressure value should not increase any further and will remain unchanged. This is recorded as the final opening pressure. Stop generating pressure at this point and allow the pressure to settle. When the pressure settles below the setpoint mark, the valve will close, and the pressure reading will settle at minimum value which is recorded as the final closing pressure.</p>
Step 8	<div data-bbox="276 987 874 1447" style="border: 1px solid black; padding: 5px;">  </div> <div data-bbox="940 987 1430 1223" style="padding: 5px;"> <p>When the Open and Close pressures are stable, select the Stop  icon softkey to end the test.</p> <p>The results of the Relief Valve test can be saved by selecting the Save  softkey.</p> </div>
Step 9	<div data-bbox="276 1525 874 1984" style="border: 1px solid black; padding: 5px;">  </div> <div data-bbox="940 1525 1430 1962" style="padding: 5px;"> <p>The default result file name will be the DPI 610E current date and time stamp. This can be renamed if required. Select the Tick softkey to confirm the Result file name and complete the save.</p> <p>If the results are saved, the test details will be cleared and the test will be restarted.</p> <p>If the results are not saved, a new test cycle can be set up ready to be run. To do this, carefully vent the system (open the pressure release knob) and then select the Restart  softkey.</p> </div>

8. External Sensors

8.1 PM700E

8.1.1 Overview

The PM700E external remote sensors extend the pressure measurement capability of a DPI 610E unit. These sensors provide pressure measuring capability from 25 mbar up to 1400 bar, with ranges available in absolute, gauge and differential models. PM700E sensors are available for both commercial and hazardous area environments. Any number of remote sensors can be individually used with a single DPI 610E, because all sensors hold their own calibration data.

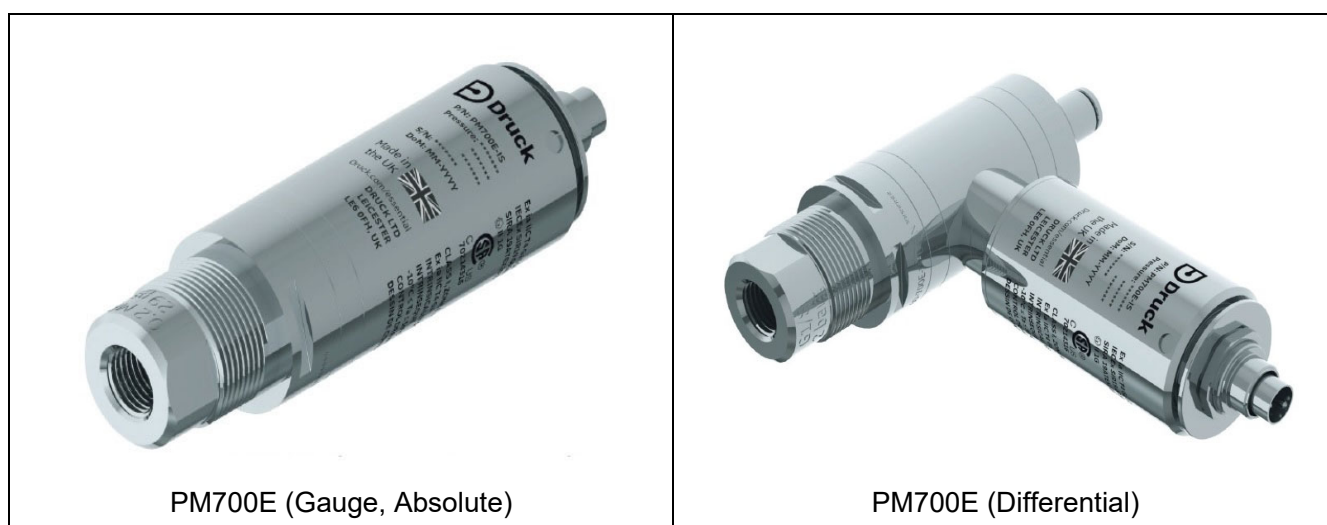

8.1.2 Media Compatibility

Care must be taken to observe media compatibility when using the PM700E. Sensor variants up to and including 3.5 bar, have exposed diaphragms, while 7 to 1400 bar variants are diaphragm isolated.

Table 8-1: Pressure and Media Compatibilities

Pressure FS	Media Compatibility
0 to 3.5 bar	Non-condensing dry gases with 316L Stainless Steel, Pyrex, Silicon, Gold, Aluminium, Glass, Silicon Dioxide and RTV Adhesive
Differential sensor reference port	Non-condensing dry gases with 316L and 304 Stainless Steel, Pyrex, Silicon, Glass, Silicon Dioxide and RTV Adhesive
7 to 200 bar	316L Stainless Steel and Hastelloy C276
350 to 1400 bar	Inconel 625 and 17-4PH Stainless Steel

Chapter 8. External Sensors

8.1.3 Setup

Each PM700E sensor is supplied with a 2.9m (9.5 feet) PM700E-CABLE. This cable is for connection of the sensor to the “EXT SENSOR” port on the side of the DPI 610E. Align the pin/slot arrangement at the female end of the cable connector with the male connector end of the sensor. The cable connector should push in with little force when it is correctly aligned. Proceed to complete the connection by rotating the locking collar until hand tight. Similarly, align the male end of the cable to the port on the DPI 610E and tighten in the same way.



The DPI 610E automatically detects any connection to a PM700E sensor. Upon successful connection of a recognised and supported sensor, a “Connected” status indication will appear for a few seconds in the status bar. Also, the screen will show an **External Sensor** icon  until the sensor is disconnected (see bottom left of screen image below). When the sensor is disconnected, a “Disconnected” status indication appears for a few seconds in the status bar and then the external sensor icon disappears.

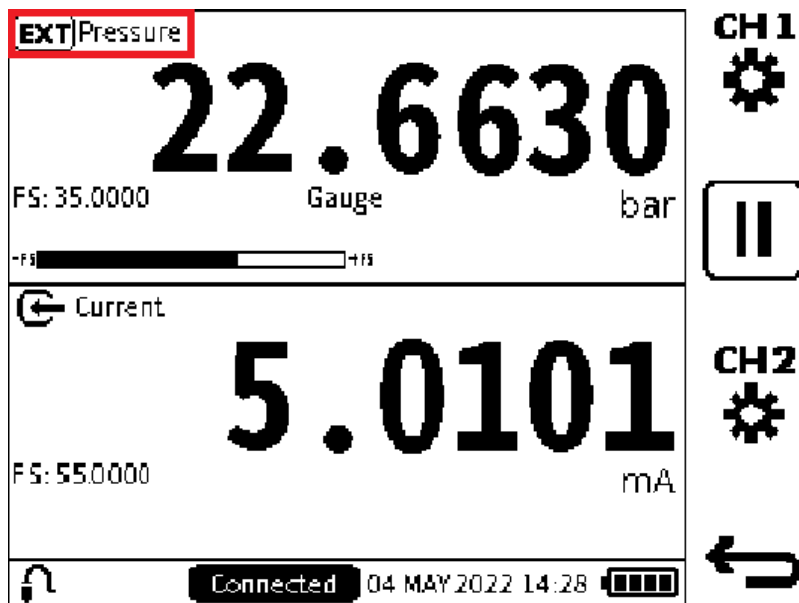

8.1.4 The Zero Function

Note: It is recommended that all gauge sensors are zeroed at the beginning of each day before use.



INFORMATION The Zero function is only available on gauge sensors. It is not possible to apply total vacuum to absolute sensors, because they can only measure atmospheric pressure. Refer to “The Zero Function” on page 75 for more information about the use of this function.

8.1.5 Available External Pressure Sensors

Only the external pressure sensors in Table 8-2 are compatible with the DPI 610E type of instrument.

Table 8-2: External Pressure Sensors for DPI 610E Range

Pressure Range	Gauge	Absolute	Differential	Barometric
25 mbar / 10 in H ₂ O / 2.5 kPa	008G	-	008L	-
70 mbar / 1 psi / 7 kPa	01G	-	01L	-
200 m bar / 3 psi / 20 kPa	02G	-	02L	-
350 m bar / 5 psi / 35 kPa	03G	03A	03L	-
700 m bar / 10 psi / 70 kPa	04G	04A	04L	-
1 bar / 15 psi / 100 kPa	05G	05A	05L	
750 - 1150 m bar / 11 - 17 psi / 75 - 115 kPa (Barometric)	-	-	-	05B
2 bar / 30 psi / 200 kPa	07G	07A	07L	-
3.5 bar / 50 psi / 350 kPa	08G	08A	-	-
7 bar / 100 psi / 700 kPa	10G	10A	-	-
10 bar / 150 psi / 1000 kPa	11G	11A	-	-
20 bar / 300 psi / 20 MPa	13G	13A	-	-
35 bar / 500 psi / 2 MPa	14G	14A	-	-
70 bar / 1000 psi / 7 MPa	16G	16A	-	-
100 bar / 1500 psi / 10 MPa	165G	165A	-	-
135 bar / 2000 psi / 13.5 MPa	17G	17A	-	-
200 bar / 3000 psi / 20 MPa	18G	18A	-	-
350 bar / 5000 psi / 35 MPa	-	20A	-	-
700 bar / 10 000 psi / 70 MPa	-	22A	-	-
1000 bar / 15 000 psi / 100 MPa	-	23A	-	-
1400 bar / 20 000 psi / 140 MPa	-	24A	-	-

Chapter 8. External Sensors

8.1.6 Configuration of an External Pressure Sensor

To configure a channel with the external remote pressure reading:

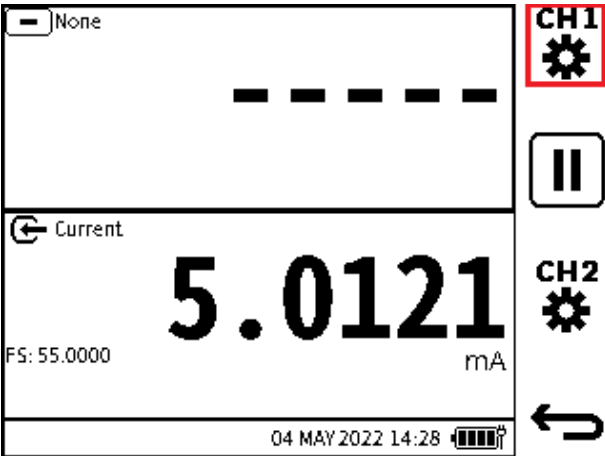
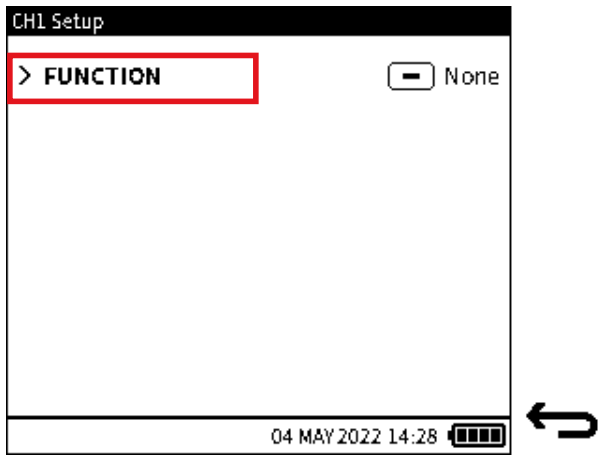
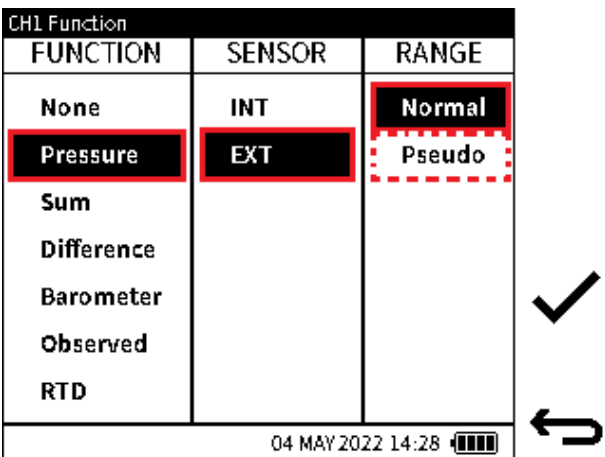
<p>Step 1</p>		<p>Select the desired channel (channel 1 in this example).</p>																											
<p>Step 2</p>		<p>Select FUNCTION from the Channel Setup screen.</p>																											
<p>Step 3</p>	 <table border="1" data-bbox="276 1426 791 1881"> <thead> <tr> <th colspan="3">CH1 Function</th> </tr> <tr> <th>FUNCTION</th> <th>SENSOR</th> <th>RANGE</th> </tr> </thead> <tbody> <tr> <td>None</td> <td>INT</td> <td>Normal</td> </tr> <tr> <td>Pressure</td> <td>EXT</td> <td>Pseudo</td> </tr> <tr> <td>Sum</td> <td></td> <td></td> </tr> <tr> <td>Difference</td> <td></td> <td></td> </tr> <tr> <td>Barometer</td> <td></td> <td></td> </tr> <tr> <td>Observed</td> <td></td> <td></td> </tr> <tr> <td>RTD</td> <td></td> <td></td> </tr> </tbody> </table>	CH1 Function			FUNCTION	SENSOR	RANGE	None	INT	Normal	Pressure	EXT	Pseudo	Sum			Difference			Barometer			Observed			RTD			<p>Select Pressure > EXT > Normal or Pseudo. Select the Tick icon to confirm the selections and show the Channel Setup screen.</p> <p>Refer to “Normal and Pseudo Pressure Range” on page 77 for more information about the use of Normal and Pseudo sensor values.</p>
CH1 Function																													
FUNCTION	SENSOR	RANGE																											
None	INT	Normal																											
Pressure	EXT	Pseudo																											
Sum																													
Difference																													
Barometer																													
Observed																													
RTD																													

The **EXT**ernal pressure function is similar to that of the **INT**ernal pressure function because it supports all the Calibrator task features associated with that of the internal pressure e.g. sensor zero, pseudo-range, leak test, switch test, relief valve etc.

If a channel is configured with the **External Pressure** function without a sensor connected, the primary reading in that channel window will be appear as “- - - -”.

If the external sensor is disconnected while the function is in use an error message may appear.

PM 700E External Remote sensors with DK481 firmware version 2.00.00 and above are fully supported for use with the DPI 610E. Sensor validation is done each time a connection is detected

If a channel is configured for External Pressure and an unsupported sensor is detected (for example a PM 700E sensor with firmware older than 2.00.00), a warning message appears

stating the sensor is not supported and the status bar will have the sensor icon  in it..

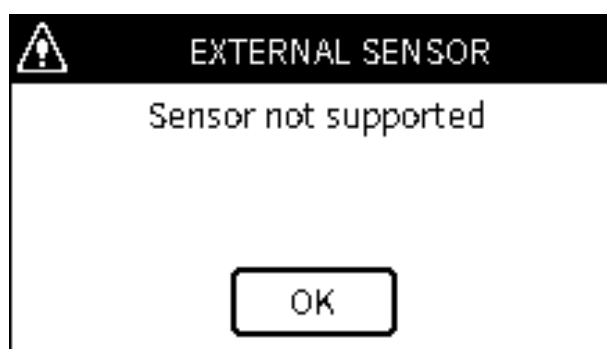

The readings from the sensor will appear as normal when configured on the Calibrator screen however, sensor calibration will not be supported using the DPI 610E. All PM700E sensors etched with a part number ending in “-3” have the correct firmware installed.

If a channel is configured for External Pressure and an unrecognised sensor is detected, a warning message appears stating the connected sensor is not compatible and the sensor icon

 will appear in the status bar.

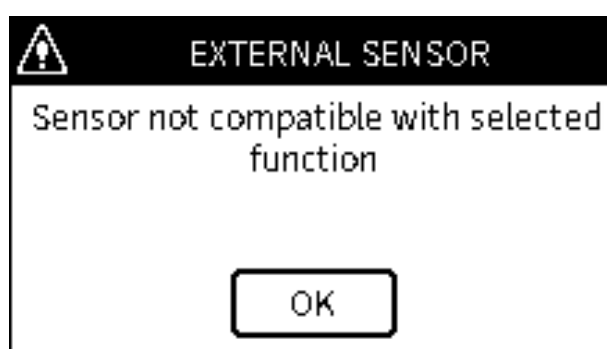

Chapter 8. External Sensors

Each time a PM 700E sensor is connected or when the DPI 610E is powered on with the sensor connected, the calibration status is checked. If the days remaining from the current DPI 610E system date to the calibration-due date of the sensor is less than 30 days, an on-screen message appears, to inform the user.

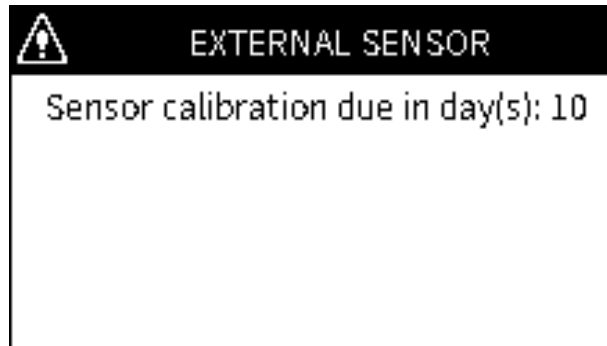

If the days remaining is 0 or less, an on-screen message appears, stating calibration is due when the sensor is detected either at power up or when the DPI 610E is already in operation. In addition, a message text "CAL DUE" will permanently be on the status bar until the sensor is disconnected or the sensor has been calibrated..

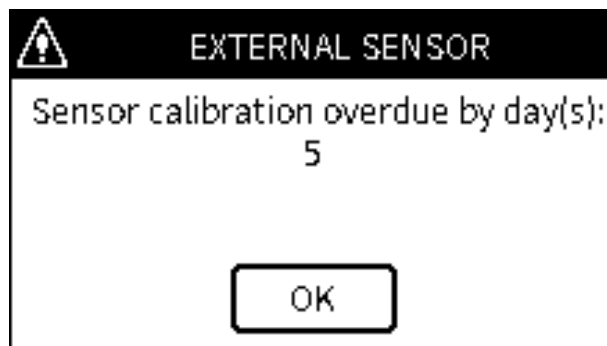

8.2 RTD Probe and Interface

8.2.1 Overview

The DPI 610E can be configured to display readings from the RTD-INTERFACE, which is a remote adapter interface and the RTD-PROBE (or any other compatible probe). Temperature measurements can be displayed as resistance or temperature units. The RTD-PROBE and RTD-INTERFACE are available in both safe and hazardous area models. The RTD-PROBE is fitted with a 15 cm (6") class-A PT100 probe. The model names are as follows:.

Table 8-3: RTD- Model Names

	Safe Area	Hazardous
RTD Interface	RTD-INTERFACE-485	RTD-INTERFACE-IS
RTD Interface with probe	RTD-PROBE-485	RTD-PROBE-IS

The RTD-PROBE/RTD-INTERFACE connects to the DPI 610E with the supplied 2.9m (9.5 feet) cable. The RTD-INTERFACE is supplied with a field-rewireable M12 connector to allow for connection by User 2,3 or 4-wire RTDs.



8.2.2 Temperature Considerations

Careful consideration must be taken when using the RTD-INTERFACE and the RTD-PROBE, or any specialist RTD probes, that the environment and process temperatures do not exceed the specified limits for each RT component as detailed in the table below.

Table 8-4: RTD-Temperature Specifications

	RTD Sensor Type	Temperature Range
	IO-RTD-PRB150	-5°C to 200°C (when used with appropriate extension cable)
	RTD-INTERFACE (BODY)	-10°C TO 50°C
Measuring temperatures	RTD-PROBE	-10°C TO 50°C when directly plugged in to RTD-INTERFACE -10°C TO 50°C when using supplied cable
	SPECIALIST RTD PROBE (Not supplied by Druck)	The capability of the RTD-INTERFACE (resistance range) with a suitable extension cable and suitable probe is 0 to 400Ω which equates to -250°C to +650°C for a PT100 probe.

Chapter 8. External Sensors

8.2.3 Setup

Connect the RTD-PROBE to the RTD-INTERFACE by screwing the probe end into the connection on the RTD-INTERFACE, if a direct connection is required. The 2 m (6.6 feet) M12 extension cable (IO-RTD-M12EXT) can be used to extend the connection between the RTD-INTERFACE and the RTD-PROBE. If using a compatible RTD not supplied by Druck, use the M12 field wireable connector (IO-RTD-M12CON) to connect the RTD probe to the RTD-INTERFACE. Note: The pin numbering is printed on the rear of the connector body.

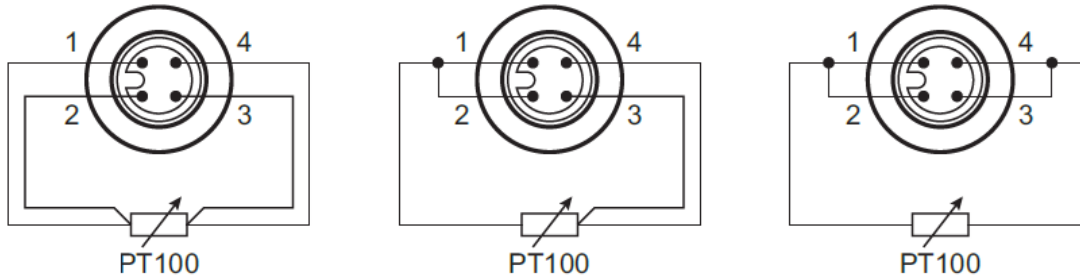

RTD M12 Connector Pinout

With the supplied RS485 sensor cable, align the pin/slot arrangement at the female end of the cable connector with the male connector end of the sensor. The cable connector should push in slightly with little force when it is correctly aligned. Proceed to complete the connection by rotating the swivel connector fully until hand tight. Similarly, align male end of the cable to the port on the DPI 610E and tighten in the same way.



The DPI 610E automatically detects any connection to the RTD-INTERFACE. Upon successful connection of a recognised and supported sensor, a “Connected” status indication appears for a few seconds in the status bar. Also, the external sensor icon  will be permanently displayed until the sensor is disconnected. When the sensor is disconnected, a “Disconnected” status indication appear for a few seconds in the status bar and the external sensor icon will disappear.

If a channel is configured with RTD function without a sensor connected, the primary reading in that channel window will be displayed as “- - - -”. If the external sensor is disconnected while the function is in use an error message may appear. The full-scale value of the RTD probe is displayed as well as the RTD probe type.

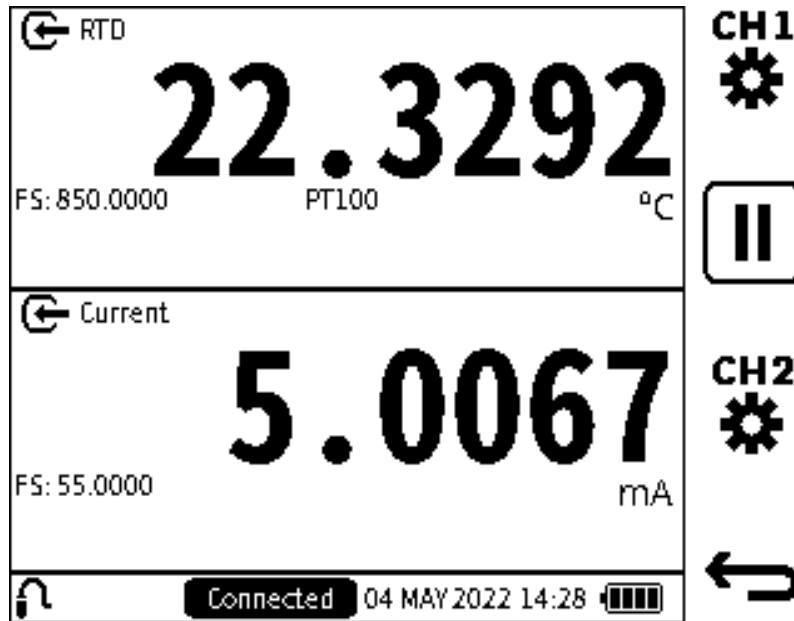

Chapter 8. External Sensors

8.2.4 Configuration of a channel for a RTD sensor

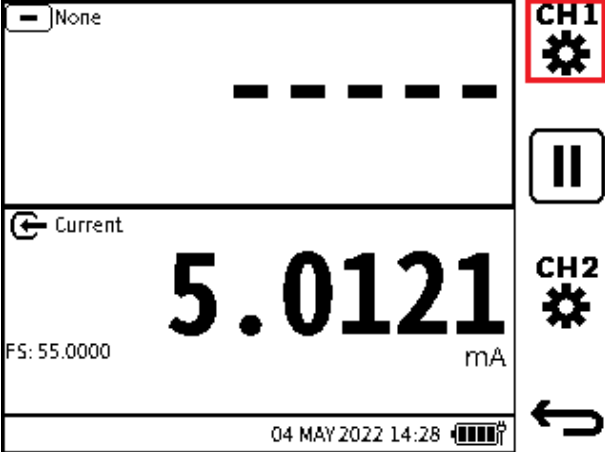
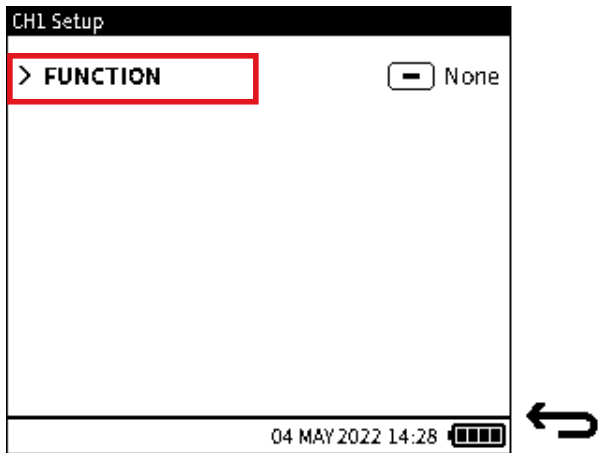
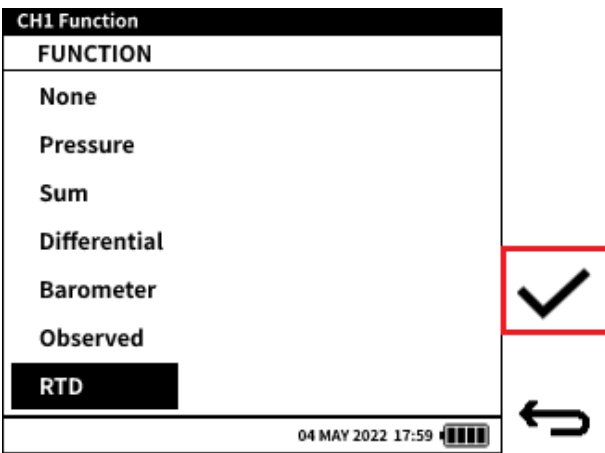
Step 1		Select the desired channel (channel 1 in this example).
Step 2		Select FUNCTION from the Channel Setup screen.
Step 3		Select RTD and select the Tick icon to confirm the selections and show the Channel Setup screen.

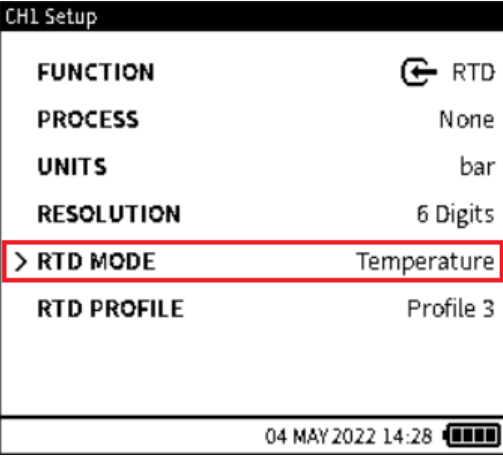
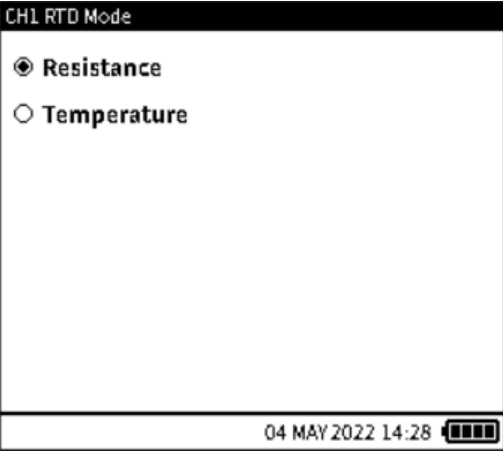
		<p>To configure the RTD measurement as resistance or temperature, select the RTD Mode option from the channel Setup screen and press the Enter key in the Navigation Pad.</p>
<p>Step 4</p>		<p>Tap in the radio button for Resistance or Temperature. Select the Tick icon to confirm the selected RTD MODE and to go back to the Channel Setup screen. The RTD Profile can now be selected if necessary.</p>

Chapter 8. External Sensors

8.2.5 RTD Profiles

The full-scale value of the RTD probe is displayed as well as the RTD probe type. When the RTD function is selected, the desired RTD profile might need to be configured by:

- Tapping on the currently saved RTD profile field in the **Channel Setup** screen.



- Using the keypad to move the selector icon to the **RTD Profile** row and pressing the **ENTER** button to show a list of the available profiles.

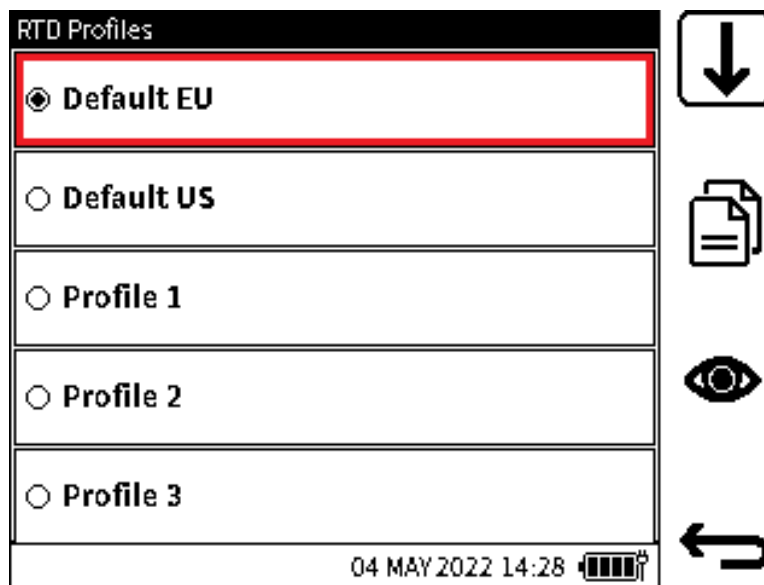

The default profile set is the “Default EU” option or PT100-PA-392, which is based on the European standard (DIN/IEC 60751) for Class A Platinum RTDs. There is also a “Default US” or PT100-PD-385, which is based on the American standard. The Default EU and Default US profile options are pre-defined and cannot be edited or deleted.

However, up to eight Custom profiles can be created by populating the user profile files available with the required coefficients, temperature range and label.

Tap on the desired profile to select it. Tap on the **View**  icon softkey to view or/and edit the coefficients and parameters within the profile. Alternatively, use the **UP/DOWN** Navigation Pad buttons to select the required profile and press the **View** softkey to view or/and edit the coefficients and parameters within the profile.

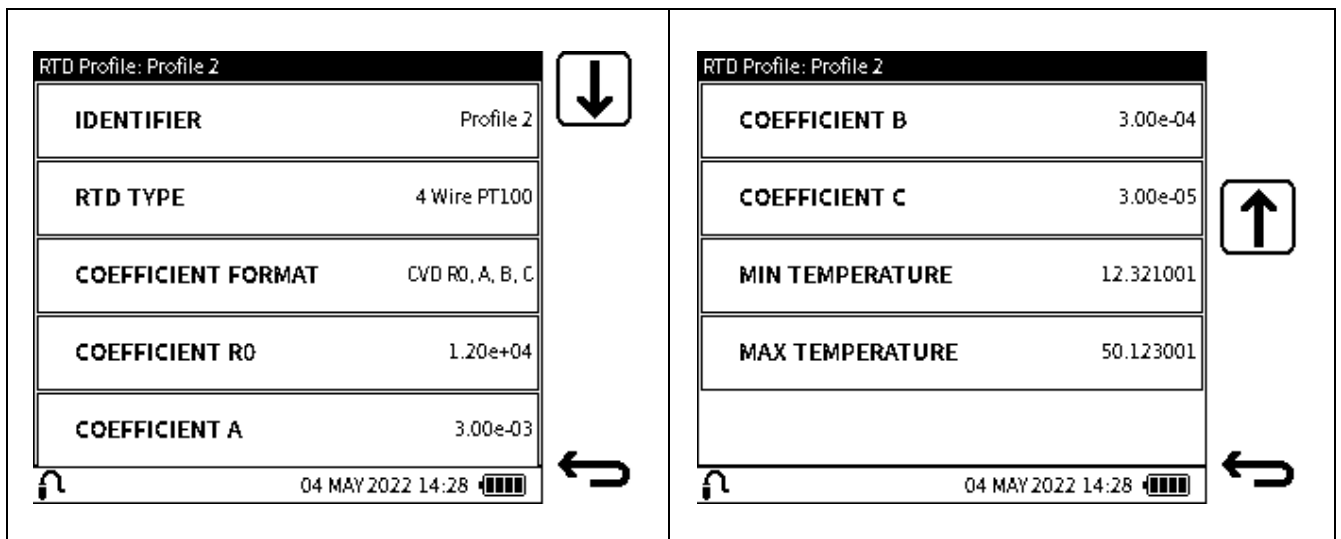

To edit any of the parameters:

- Tap on the value field of the desired parameter:
 - Use the **UP/DOWN** buttons to move the selector icon to the required parameter to change. Press the **Enter** button to enter the edit screen of the parameter. Press or tap the **Tick** icon softkey to accept and save the new values.

It is possible to copy the parameters saved in any of the profiles to a custom profile. Note the Default EU and Default US profiles cannot be overwritten but can be copied into any of the custom profiles. Custom profiles are saved in the RTD-INTERFACE not on the DPI 610E.

Table 8-5: RTD Profile parameters

Parameter	Description
Identifier	Give the custom profile a unique label
RTD Type	Select from 2, 3, 4 wire RTD configuration. 4-wire is default.
Coefficient Format	Select from Callendar-Van Dusen equation formats or use the ITS90 equation format.
Coefficient R0	Resistance at 0°C
Coefficient 1 (a, A, Alpha)	First coefficient value
Coefficient 2 (b, B, Beta)	Second coefficient value
Coefficient 3 (c, C, Delta)	Third coefficient value
Min. Temperature	Minimum temperature
Max. Temperature	Maximum temperature

When all parameter fields are filled, use the **Back** softkey to go back to the **RTD Profile** screen.

Chapter 8. External Sensors

8.2.5.1 To copy a RTD profile

Select the desired profile:

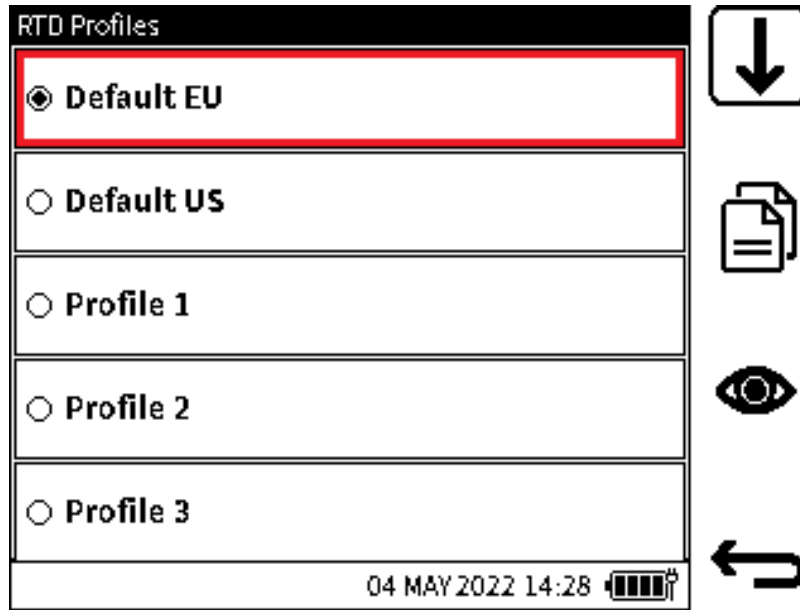

Once selected, tap or press the **Copy**  icon softkey and then select the desired destination profile, for example: Profile 1.

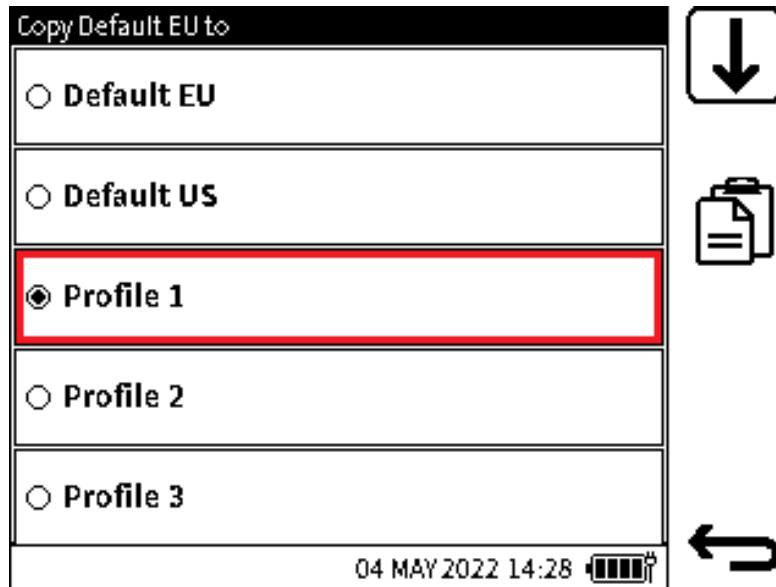

8.2.5.2 RTD Units

When in Resistance mode, the only units available to select are Ohms (Ω) and Custom units. In Temperature mode, select from $^{\circ}\text{C}$, $^{\circ}\text{F}$ or Custom units. Refer to Section 6.3.6 on page 122 for information about Custom units.

9. Data Log

The **Data Log** function records instrument readings (measured or sourced) so that they can be reviewed or analyzed. The following options are available under the **Data Log** menu:

Option	Description
Setup	Set up data log
Files	View and delete data log files

To access Data Log:

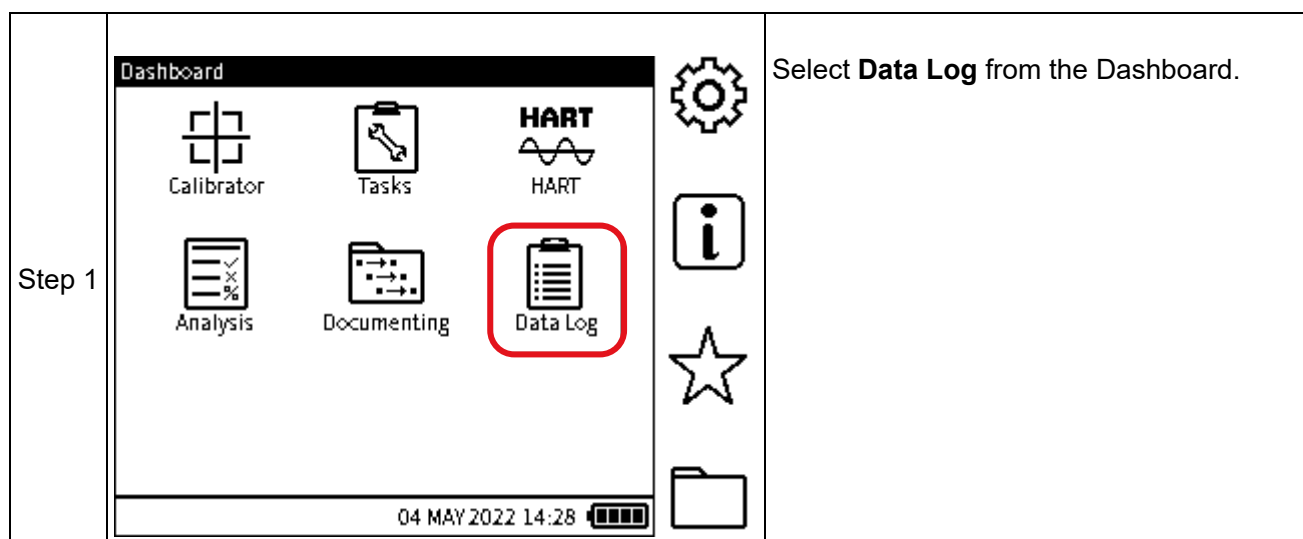

9.1 Data Log Setup Menu

The following options are available under the **Setup** menu:

Option	Description
FILENAME	Change file name
TRIGGER	Set Data Log trigger
TIME INTERVAL	Set Data Log time interval
LOG DURATION	Set Log duration
DATA POINTS	Set Data Log points

Note: Select the **TRIGGER** mode first (See Section 9.2 on page 158) before setting the filename of the data log.

TIME INTERVAL, **LOG DURATION** and **DATA POINTS** are only listed in the **Data Log Setup** menu when **TRIGGER** is set to **PERIODIC** (See Section).

Chapter 9. Data Log

9.1.1 How to set the Data Log Filename

To set the Data Log filename:

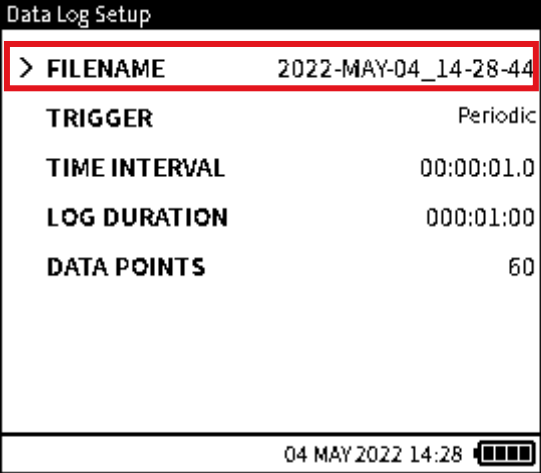
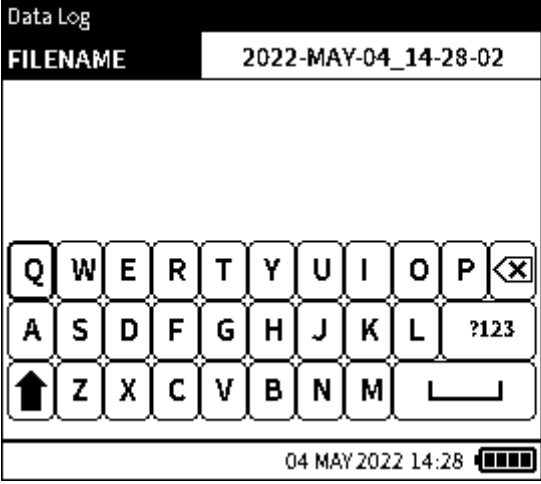
Step 1	 <p>The screenshot shows the 'Data Log' menu with 'SETUP' highlighted in a red box. Below it is the 'FILES' option. The status bar at the bottom shows '04 MAY 2022 14:28' and a battery icon. A right-pointing arrow icon is located to the right of the screen.</p>	Select SETUP from the Data Log screen.
Step 2	 <p>The screenshot shows the 'Data Log Setup' screen. 'FILENAME' is highlighted in a red box with the value '2022-MAY-04_14-28-44'. Other options include TRIGGER (Periodic), TIME INTERVAL (00:00:01.0), LOG DURATION (000:01:00), and DATA POINTS (60). The status bar at the bottom shows '04 MAY 2022 14:28' and a battery icon. A right-pointing arrow icon is located to the right of the screen.</p>	Select Filename from the Data Log Setup screen. Note: TIME INTERVAL , LOG DURATION and DATA POINTS are only listed on the Data Log Setup screen when TRIGGER is set to periodic.
Step 3	 <p>The screenshot shows the 'Data Log' screen with 'FILENAME' highlighted and the value '2022-MAY-04_14-28-02'. A keyboard overlay is visible below the screen. The status bar at the bottom shows '04 MAY 2022 14:28' and a battery icon. A right-pointing arrow icon is located to the right of the screen.</p>	Select the Eraser to delete the default data log file name. Note: The default data log file name format is: [YYYY-MMM-DD_HH-MM-SS].

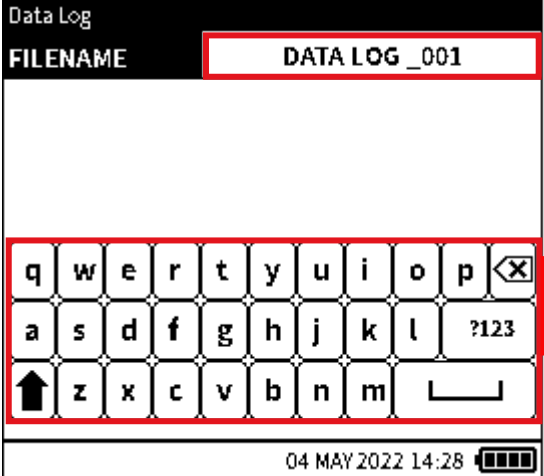
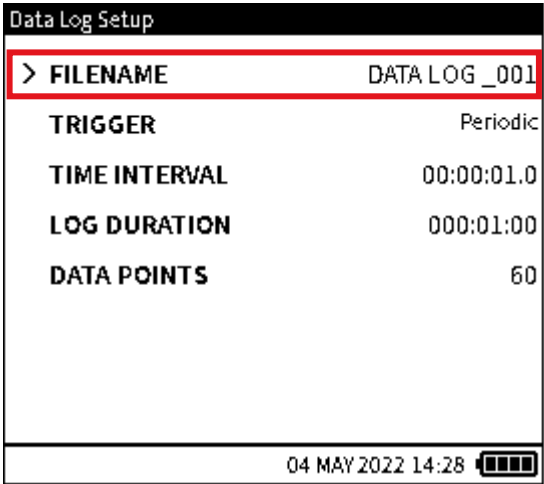
<p>Step 4</p>		<p>Use the keypad to enter the new Data Log filename.</p> <p>Note: Only a maximum of 20 characters and symbols is available.</p> <p>Select ✓ to confirm the new file name.</p>
<p>Step 5</p>		<p>Check that the new filename appears in the Data Log Setup screen.</p> <p>Note: TIME INTERVAL, LOG DURATION and DATA POINTS are only listed on the Data Log Setup screen when TRIGGER is set to Periodic.</p>

9.2 TRIGGER Menu

The **TRIGGER** menu allows the user to select the type **Data Log Trigger** requirement. The following options are available under the **TRIGGER** menu:

Option	Description
KEY PRESS	Data Log triggered by a key press
PERIODIC	Periodic Data Log

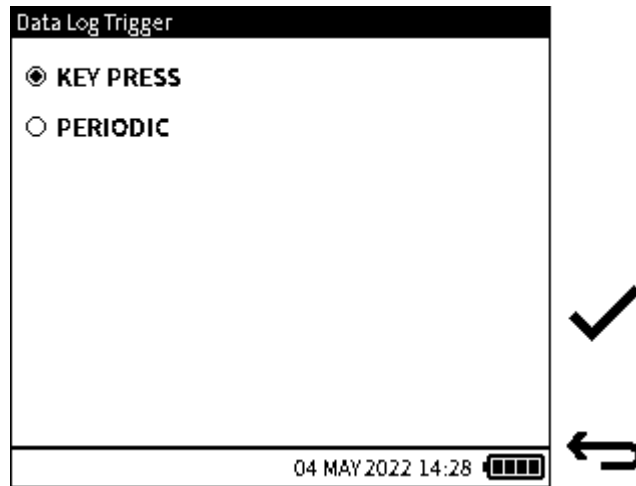

Figure 9-1: Data Log Trigger Menu

When **KEY PRESS** is selected, no more settings will be required to set up the data log. Click the tick ✓ icon to return to the **Data Log Setup** screen: select **FILENAME** if a new name for the data log file is needed (See Section 9.1.1 on page 156 for the procedure). Refer to Section 9.4 on page 164, to continue the instructions for **KEY PRESS** data logging.

When the **PERIODIC** trigger is selected, more recording options become available for configuration.

9.3 Periodic Trigger Options

The options **TIME INTERVAL**, **LOG DURATION** and **DATA POINTS** are only available for use when **PERIODIC** is the trigger mode for recording data results.

9.3.1 TIME INTERVAL

When a Periodic trigger is selected, the option to set the Periodic interval is available from the **Data Log Setup** screen. The interval determines how long each data point is logged and it is expressed as HH:MM:SS.S. The supported time interval range is between 00:00:00.2 to 23:59:59.9. The minimum interval supported is dependent on the functions configured in the Calibrator channels. See table below.

Function	Minimum Interval (HH:MM:SS.S)
Internal Barometer	00:00:05.0
Internal Pressure	00:00:00.2
External Sensor (Pressure and RTD)	00:00:00.2
Current / Voltage / Millivolt Measure	00:00:00.5
Current Source	00:00:01.0
HART	00:00:00.5

9.3.1.1 How to set the TIME INTERVAL

Step 1		<p>Select TIME INTERVAL from the Data Log Setup screen.</p>
--------	--	---

Chapter 9. Data Log

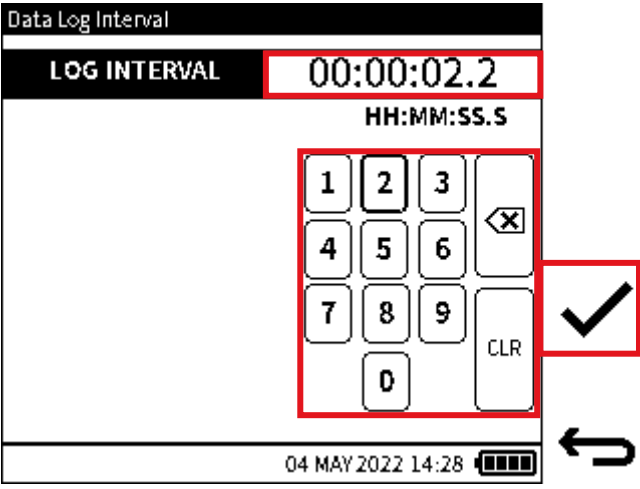
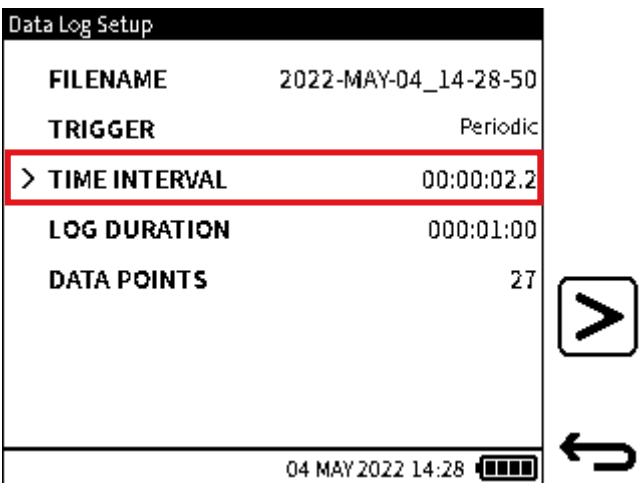
Step 2		<p>Use the keypad to set the LOG INTERVAL. Select ✓ to confirm.</p> <p>Note: The time interval must be entered in the [HH:MM:SS.S] format in the range [00:00:01] to [23.59.9].</p>
Step 3		<p>Check that required interval appears in the TIME INTERVAL row of the Data Log Setup screen.</p>

9.3.2 LOG DURATION

When a Periodic trigger is selected, the option to set the Data Log Duration is available from the **Data Log Setup** screen. The log duration determines the period over which the logging will take place i.e., start to end. It is expressed as HH:MM:SS. The supported time interval range is between 00:00:01 to 999:59:59.

Note: The time interval value must always be less than the **LOG DURATION** value.

9.3.2.1 How to set the LOG DURATION

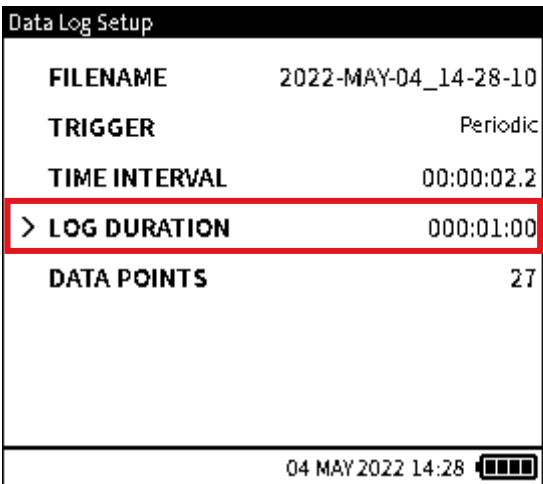
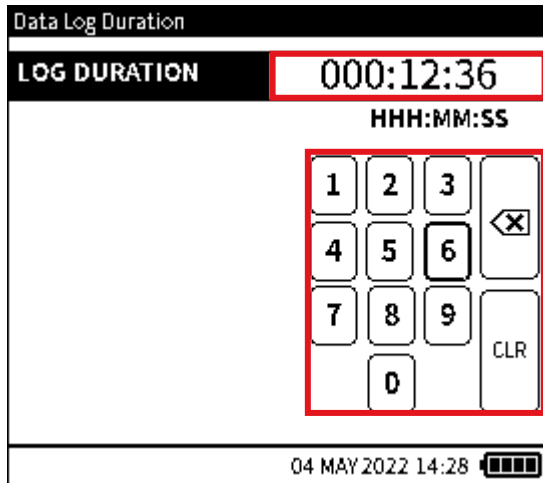
<p>Step 1</p>	 <p>The screenshot shows the 'Data Log Setup' screen with the following fields: FILENAME (2022-MAY-04_14-28-10), TRIGGER (Periodic), TIME INTERVAL (00:00:02.2), LOG DURATION (000:01:00), and DATA POINTS (27). The LOG DURATION field is highlighted with a red box. A red arrow points to the right, and a red arrow points down.</p>	<p>Select LOG DURATION from the Data Log Setup screen.</p>
<p>Step 2</p>	 <p>The screenshot shows the 'Data Log Duration' screen with the LOG DURATION field set to 000:12:36. Below the field is an onscreen keypad with numbers 1-9, 0, a backspace key, and a CLR key. A red box highlights the keypad, and a red checkmark is shown next to it.</p>	<p>Use the onscreen keypad to set the LOG DURATION value. Select ✓ to confirm.</p> <p>Note: The time interval must be entered in the [HHH:MM:SS] format in the range [000:00:01] to [999.59.59].</p>

Step 3	<p>The screenshot shows the 'Data Log Setup' menu with the following items: FILENAME (2022-MAY-04_14-28-30), TRIGGER (Periodic), TIME INTERVAL (00:00:02.2), > LOG DURATION (000:12:36), and DATA POINTS (343). The 'LOG DURATION' item is highlighted with a red border. Navigation arrows (right, left, and up) are visible on the right side of the screen.</p>	<p>Check that required duration appears in the LOG DURATION section of the Data Log Setup screen.</p>
--------	---	---

9.3.3 DATA POINTS

When a Periodic trigger is selected, the number of data points configured is displayed in the **Data Log Setup** screen. The number of data points is directly linked to the time interval and the log duration configured. For example, if a time interval of 10 seconds (00:00:10.0) and log duration of 1 minute (000:01:00) is configured, the number of data points displayed in the setup menu will be 6. Each time the time interval or log duration value is changed, the number of data points is automatically adjusted. Alternatively, the periodic data log can be configured by specifying the number of data points required and the time interval or sampling frequency. From the previous example, if the number of data points is changed from 6 to 5, the log duration will automatically adjust to 50 seconds (000:00:50) based on the unchanged time interval of 10 seconds and the new number of required data points.





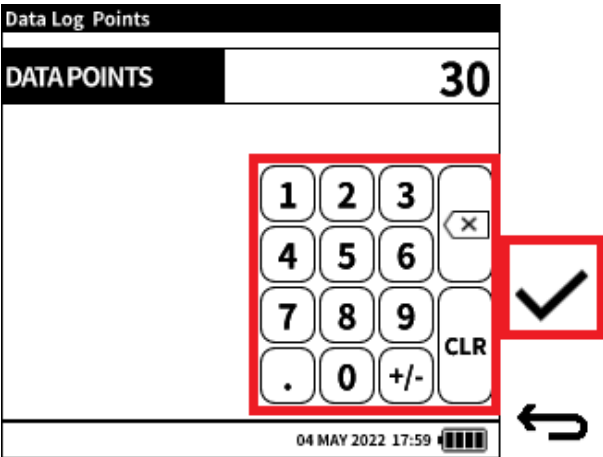
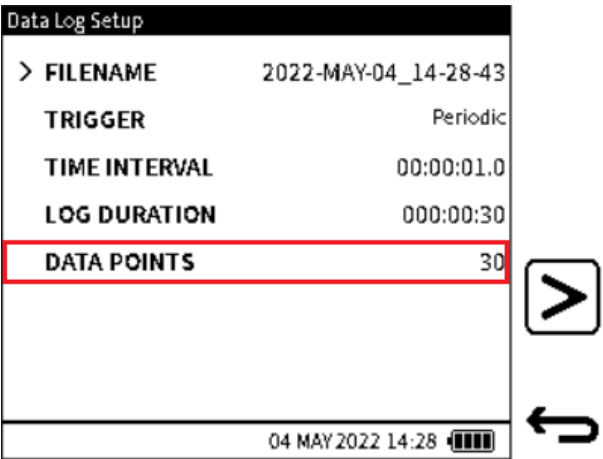

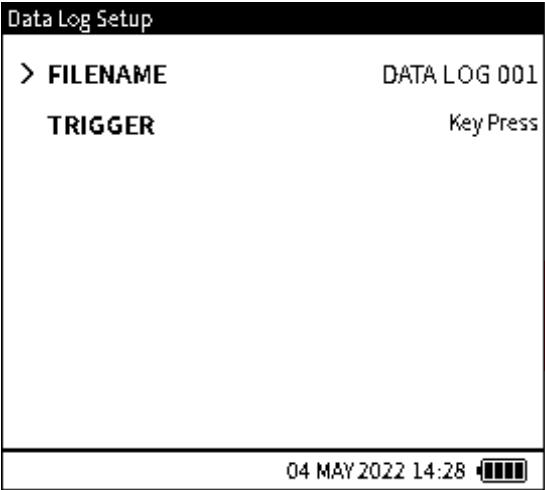

9.3.3.1 How to set the DATA POINTS

Step 1	<p>The screenshot shows the 'Data Log Setup' menu with the following items: FILENAME (2022-MAY-04_14-28-54), TRIGGER (Periodic), TIME INTERVAL (00:00:02.2), LOG DURATION (000:12:36), and > DATA POINTS (343). The 'DATA POINTS' item is highlighted with a red border. Navigation arrows (right, left, and up) are visible on the right side of the screen.</p>	<p>Select DATA POINTS from the Data Log Setup screen</p>
--------	--	--

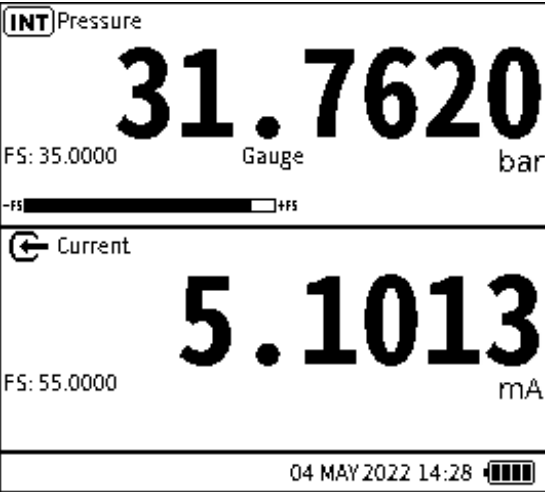
<p>Step 2</p>		<p>Use the keypad to set the number of data points. Select ✓ to confirm.</p>
<p>Step 3</p>		<p>Check that required number of data points appears in the DATA POINTS field of the Data Log Setup screen.</p>

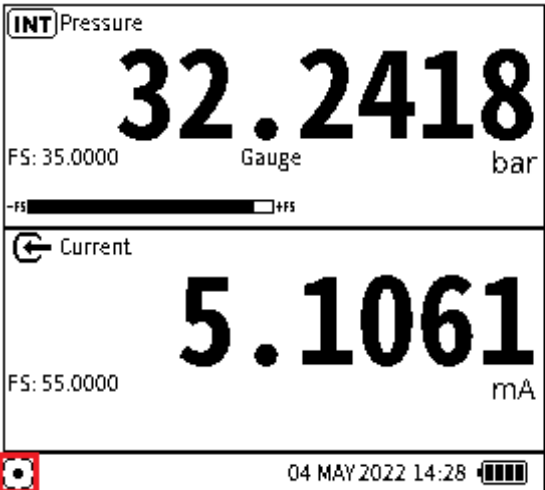
9.4 Setting up Manual Data Logging



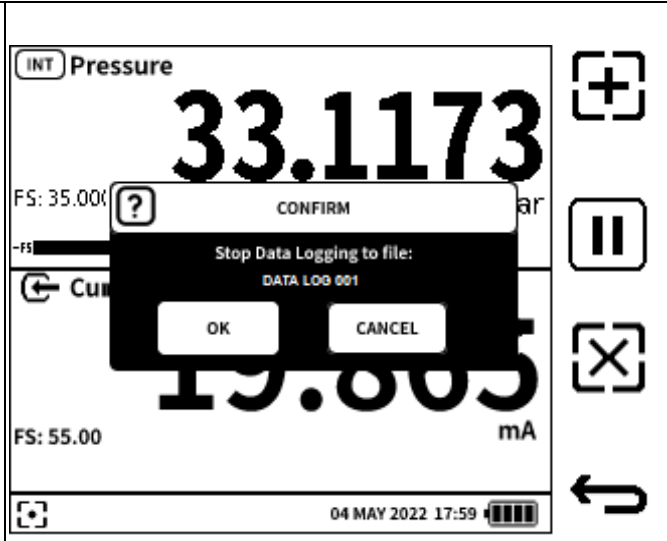

The **KEY PRESS** option (see Section 9.2) is a manual data trigger. Use the following steps to continue with a **KEY PRESS** triggered Data Log session:

<p>Step 1</p>		<p>Select the PLAY  icon in the Data Log Setup screen.</p>
<p>Step 2</p>		<p>The Calibration main screen appears. Press the KEY PRESS RECORD  icon to start the data logging session.</p>
<p>Step 3</p>		<p>The Data Log Status icon will appear in the status bar until the logging is complete. Press the Start Logging Data  icon to log data when wanted. To temporarily stop the testing press the Hold  icon. To restart the testing press the Hold icon again. To stop data logging completely press the X  icon.</p>

<p>Step 4</p>		<p>A popup message appears that requests confirmation that the data log session is to end. Select OK to end the session or cancel to continue. If you select OK, another popup message will appear to confirm the data log file has been saved.</p>
---------------	---	---

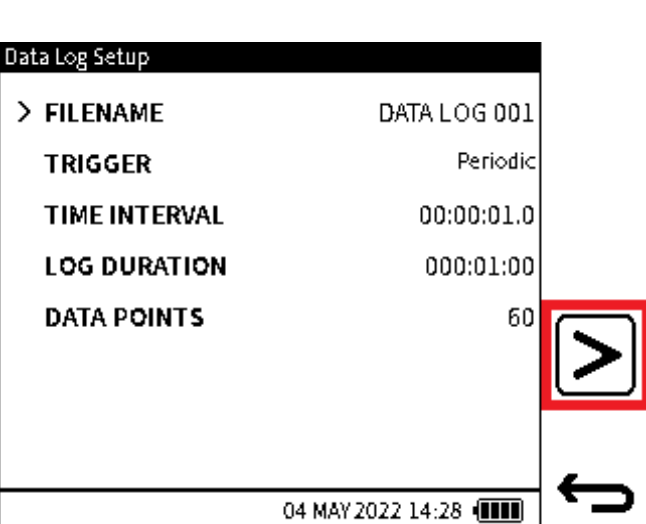
9.5 Setting up Periodic Data Logging

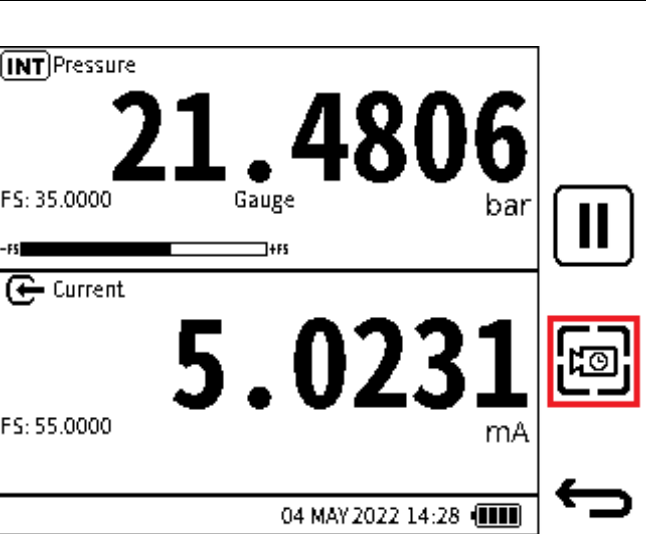
The **PERIODIC** option is a time-based data trigger (see Section 9 on page 155, Section 9.2 on page 158 and Section 9.3 on page 159). Use the following steps to continue with a **PERIODIC** triggered Data Log session:

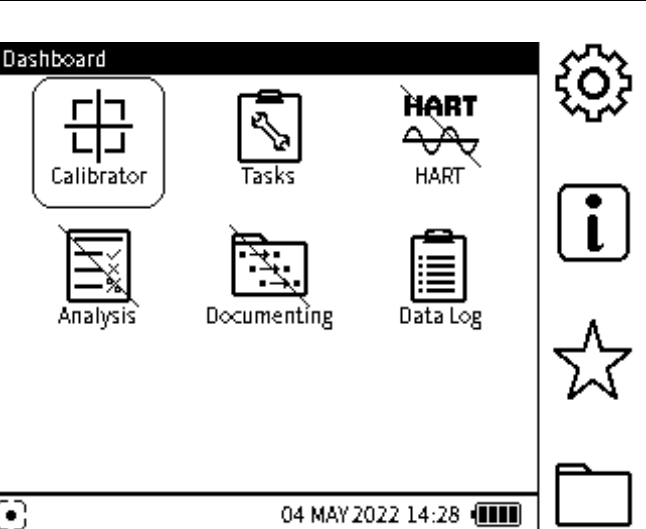
<p>Step 1</p>		<p>After selecting the PERIODIC Data Log mode and the values of the PERIODIC options, select the PLAY  icon in the Data Log Setup screen. The Calibrator main screen appears.</p>
<p>Step 2</p>		<p>To start the periodic logging, select the Periodic Data Log  softkey. This is similar to the icon for the Key Press Data Log icon except it has a clock in its center rather than an addition sign.</p> <p>At this point, the Data Log Status  icon appears in the status bar until the logging is complete. Periodic logging is automatic, based on the configurations in the Setup menu. At the end of the session, a popup message appears, to confirm that data logging is complete. The file is saved automatically.</p>
		<p>It is not possible to change the channel configuration once data logging has begun. If at any point during data logging, the user navigates to the Dashboard, some applications which may interfere with the logging will be disabled. Such applications will have a slash across the icon on the Dashboard.</p>

9.6 Viewing & Deleting Data Log files

9.6.1 Viewing Data Log Files

To view the **Data Log** files:

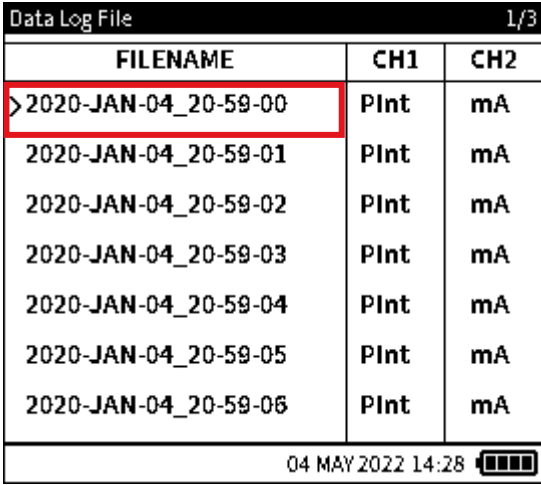
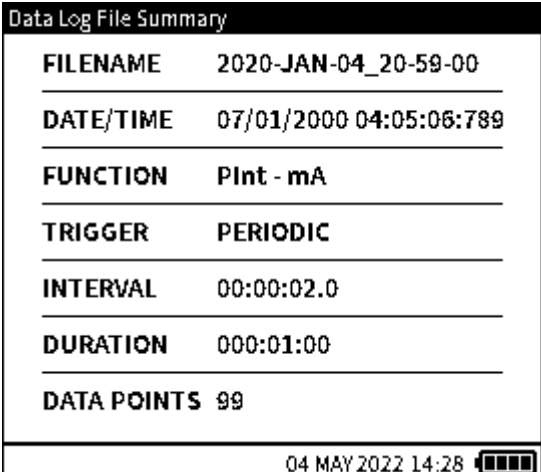
Step 1	 <p>The screenshot shows the 'Data Log' menu with 'SETUP' and '> FILES' options. The 'FILES' option is highlighted with a red box. The status bar at the bottom shows '04 MAY 2022 14:28' and a battery icon. A red arrow points to the right.</p>	Select FILES in the Data Log screen.																								
Step 2	 <p>The screenshot shows a list of data log files. The first file, '>2020-JAN-04_20-59-00', is highlighted with a red box. To the right of the list are icons for deleting files (trash can) and a downward arrow. A red box highlights the 'Clipboard' icon at the bottom right. The status bar at the bottom shows '04 MAY 2022 14:28' and a battery icon. A red arrow points to the right.</p> <table border="1" data-bbox="264 965 807 1368"> <thead> <tr> <th>FILENAME</th> <th>CH1</th> <th>CH2</th> </tr> </thead> <tbody> <tr> <td>>2020-JAN-04_20-59-00</td> <td>PInt</td> <td>mA</td> </tr> <tr> <td>2020-JAN-04_20-59-01</td> <td>PInt</td> <td>mA</td> </tr> <tr> <td>2020-JAN-04_20-59-02</td> <td>PInt</td> <td>mA</td> </tr> <tr> <td>2020-JAN-04_20-59-03</td> <td>PInt</td> <td>mA</td> </tr> <tr> <td>2020-JAN-04_20-59-04</td> <td>PInt</td> <td>mA</td> </tr> <tr> <td>2020-JAN-04_20-59-05</td> <td>PInt</td> <td>mA</td> </tr> <tr> <td>2020-JAN-04_20-59-06</td> <td>PInt</td> <td>mA</td> </tr> </tbody> </table>	FILENAME	CH1	CH2	>2020-JAN-04_20-59-00	PInt	mA	2020-JAN-04_20-59-01	PInt	mA	2020-JAN-04_20-59-02	PInt	mA	2020-JAN-04_20-59-03	PInt	mA	2020-JAN-04_20-59-04	PInt	mA	2020-JAN-04_20-59-05	PInt	mA	2020-JAN-04_20-59-06	PInt	mA	Tap on (or use the Navigation Pad) to select the required Data Log file.
FILENAME	CH1	CH2																								
>2020-JAN-04_20-59-00	PInt	mA																								
2020-JAN-04_20-59-01	PInt	mA																								
2020-JAN-04_20-59-02	PInt	mA																								
2020-JAN-04_20-59-03	PInt	mA																								
2020-JAN-04_20-59-04	PInt	mA																								
2020-JAN-04_20-59-05	PInt	mA																								
2020-JAN-04_20-59-06	PInt	mA																								
Step 3	 <p>The screenshot shows the 'Data Log File Summary' screen with the following details:</p> <table border="1" data-bbox="264 1469 807 1939"> <tbody> <tr> <td>FILENAME</td> <td>2020-JAN-04_20-59-00</td> </tr> <tr> <td>DATE/TIME</td> <td>07/01/2000 04:05:06.789</td> </tr> <tr> <td>FUNCTION</td> <td>PInt - mA</td> </tr> <tr> <td>TRIGGER</td> <td>PERIODIC</td> </tr> <tr> <td>INTERVAL</td> <td>00:00:02.0</td> </tr> <tr> <td>DURATION</td> <td>000:01:00</td> </tr> <tr> <td>DATA POINTS</td> <td>99</td> </tr> </tbody> </table> <p>The 'Clipboard' icon is highlighted with a red box. The status bar at the bottom shows '04 MAY 2022 14:28' and a battery icon. A red arrow points to the right.</p>	FILENAME	2020-JAN-04_20-59-00	DATE/TIME	07/01/2000 04:05:06.789	FUNCTION	PInt - mA	TRIGGER	PERIODIC	INTERVAL	00:00:02.0	DURATION	000:01:00	DATA POINTS	99	Select the Clipboard icon on the Data Log File Summary .										
FILENAME	2020-JAN-04_20-59-00																									
DATE/TIME	07/01/2000 04:05:06.789																									
FUNCTION	PInt - mA																									
TRIGGER	PERIODIC																									
INTERVAL	00:00:02.0																									
DURATION	000:01:00																									
DATA POINTS	99																									

Chapter 9. Data Log

Step 4

↓

↶

View **Data Log** file.

9.6.2 How to use a PC to view Data Log files in the DPI 610E

Data log files are saved as csv format in the DPI 610E internal memory. Use a micro- USB data cable to connect the DPI 610E device to the PC (See Section 9.7 on page 172). On the PC, the DPI610E memory appears as a mass storage device or drive within Windows File Explorer.

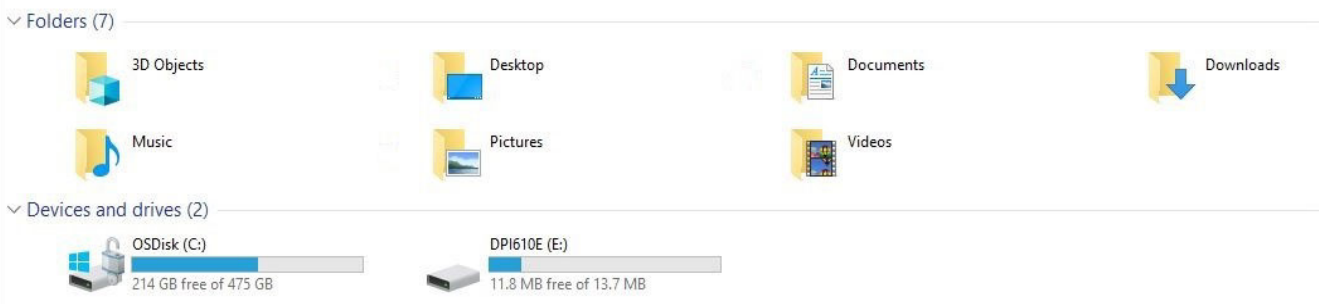

Double-click on the DPI 610E drive and select the **DataLog** folder from the root directory.

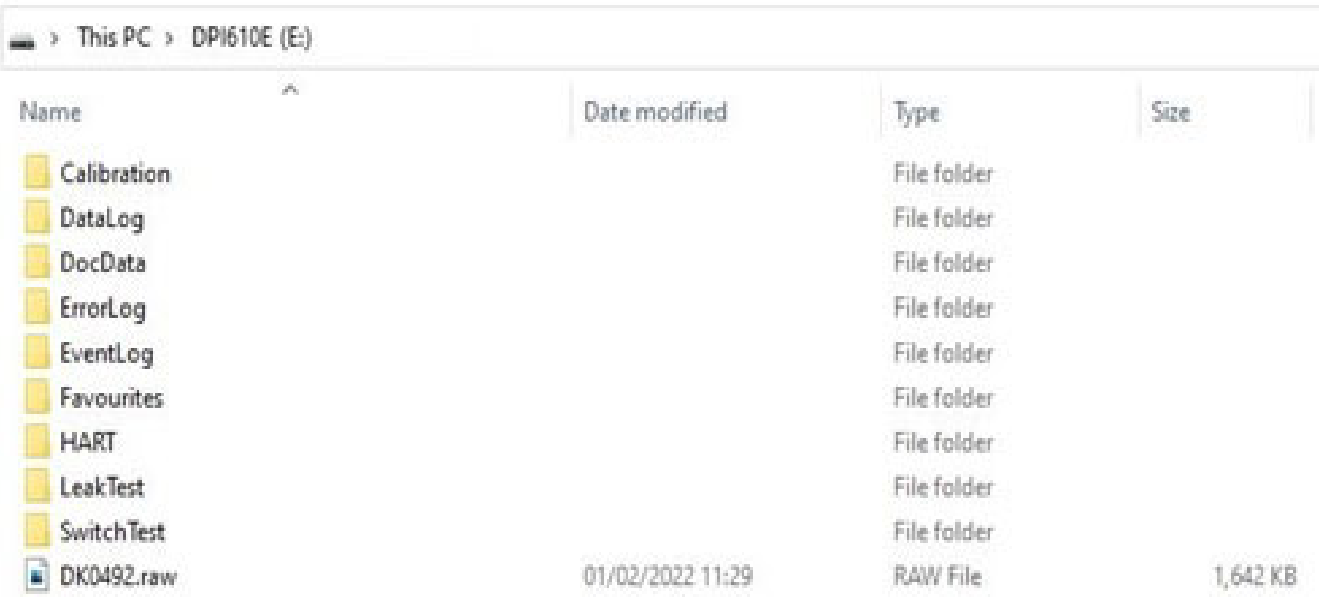

Right-click on the desired log file, and choose a supported application to open the file and view the contents: Microsoft Excel is recommended.

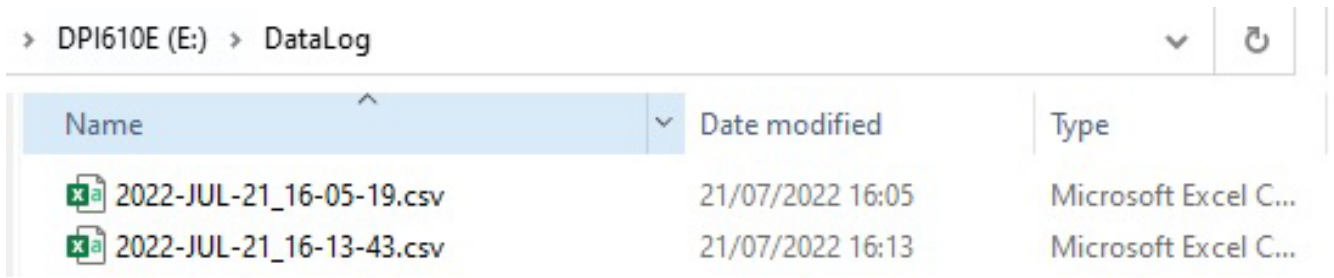





9.6.3 Deleting Data Log Files

9.6.3.1 To delete a single Data Log file

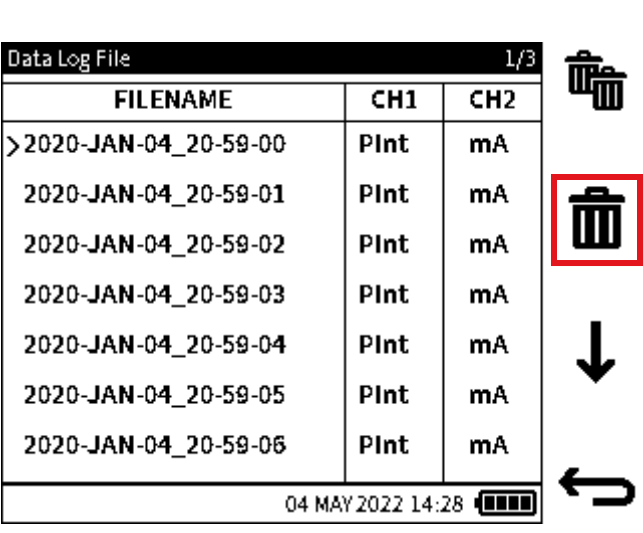
<p>Step 1</p>	<p>The screenshot shows a 'Data Log' screen with a 'SETUP' header and a '> FILES' option highlighted with a red box. At the bottom, it shows the date '04 MAY 2022 14:28' and a battery icon. A curved arrow points from the bottom right of this screen to the top right of the next screen.</p>	<p>Select FILES from the Data Log screen.</p>																								
<p>Step 2</p>	<p>The screenshot shows a 'Data Log File' screen with a table of files. The first row is highlighted with a red box. A trash icon is visible to the right of the table. At the bottom, it shows the date '04 MAY 2022 14:28' and a battery icon. A curved arrow points from the bottom right of this screen to the top right of the next screen.</p> <table border="1"> <thead> <tr> <th>FILENAME</th> <th>CH1</th> <th>CH2</th> </tr> </thead> <tbody> <tr> <td>>2020-JAN-04_20-59-00</td> <td>PInt</td> <td>mA</td> </tr> <tr> <td>2020-JAN-04_20-59-01</td> <td>PInt</td> <td>mA</td> </tr> <tr> <td>2020-JAN-04_20-59-02</td> <td>PInt</td> <td>mA</td> </tr> <tr> <td>2020-JAN-04_20-59-03</td> <td>PInt</td> <td>mA</td> </tr> <tr> <td>2020-JAN-04_20-59-04</td> <td>PInt</td> <td>mA</td> </tr> <tr> <td>2020-JAN-04_20-59-05</td> <td>PInt</td> <td>mA</td> </tr> <tr> <td>2020-JAN-04_20-59-06</td> <td>PInt</td> <td>mA</td> </tr> </tbody> </table>	FILENAME	CH1	CH2	>2020-JAN-04_20-59-00	PInt	mA	2020-JAN-04_20-59-01	PInt	mA	2020-JAN-04_20-59-02	PInt	mA	2020-JAN-04_20-59-03	PInt	mA	2020-JAN-04_20-59-04	PInt	mA	2020-JAN-04_20-59-05	PInt	mA	2020-JAN-04_20-59-06	PInt	mA	<p>Tap on (or use the Navigation Pad) to select the required Data Log file.</p>
FILENAME	CH1	CH2																								
>2020-JAN-04_20-59-00	PInt	mA																								
2020-JAN-04_20-59-01	PInt	mA																								
2020-JAN-04_20-59-02	PInt	mA																								
2020-JAN-04_20-59-03	PInt	mA																								
2020-JAN-04_20-59-04	PInt	mA																								
2020-JAN-04_20-59-05	PInt	mA																								
2020-JAN-04_20-59-06	PInt	mA																								

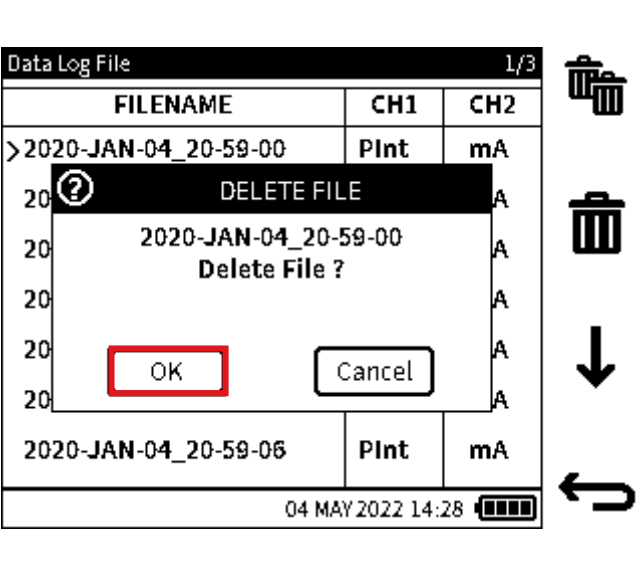
Chapter 9. Data Log

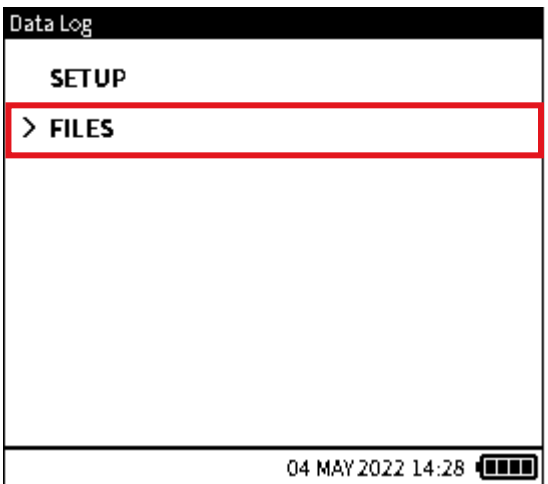
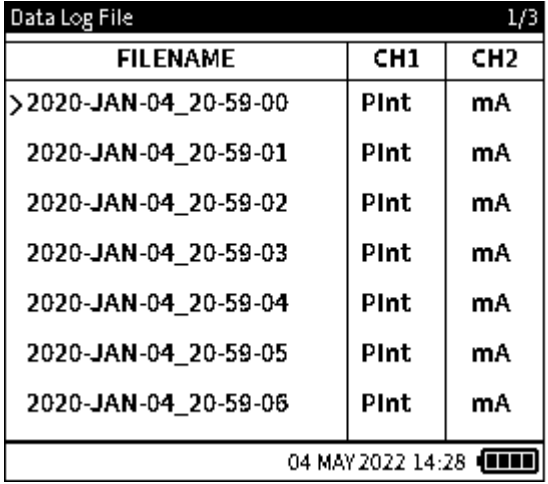
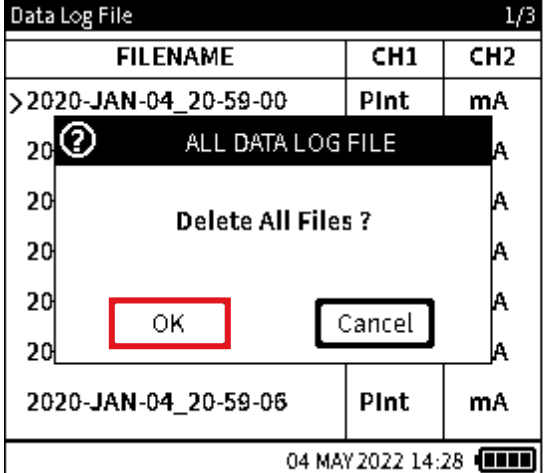

<p>Step 3</p>	 <table border="1"> <thead> <tr> <th colspan="3">Data Log File 1/3</th> </tr> <tr> <th>FILENAME</th> <th>CH1</th> <th>CH2</th> </tr> </thead> <tbody> <tr> <td>>2020-JAN-04_20-59-00</td> <td>PInt</td> <td>mA</td> </tr> <tr> <td>2020-JAN-04_20-59-01</td> <td>PInt</td> <td>mA</td> </tr> <tr> <td>2020-JAN-04_20-59-02</td> <td>PInt</td> <td>mA</td> </tr> <tr> <td>2020-JAN-04_20-59-03</td> <td>PInt</td> <td>mA</td> </tr> <tr> <td>2020-JAN-04_20-59-04</td> <td>PInt</td> <td>mA</td> </tr> <tr> <td>2020-JAN-04_20-59-05</td> <td>PInt</td> <td>mA</td> </tr> <tr> <td>2020-JAN-04_20-59-06</td> <td>PInt</td> <td>mA</td> </tr> </tbody> </table> <p>04 MAY 2022 14:28 </p>	Data Log File 1/3			FILENAME	CH1	CH2	>2020-JAN-04_20-59-00	PInt	mA	2020-JAN-04_20-59-01	PInt	mA	2020-JAN-04_20-59-02	PInt	mA	2020-JAN-04_20-59-03	PInt	mA	2020-JAN-04_20-59-04	PInt	mA	2020-JAN-04_20-59-05	PInt	mA	2020-JAN-04_20-59-06	PInt	mA	<p>Select the 'single' trash icon on the Data Log File screen.</p>
Data Log File 1/3																													
FILENAME	CH1	CH2																											
>2020-JAN-04_20-59-00	PInt	mA																											
2020-JAN-04_20-59-01	PInt	mA																											
2020-JAN-04_20-59-02	PInt	mA																											
2020-JAN-04_20-59-03	PInt	mA																											
2020-JAN-04_20-59-04	PInt	mA																											
2020-JAN-04_20-59-05	PInt	mA																											
2020-JAN-04_20-59-06	PInt	mA																											
<p>Step 4</p>	 <table border="1"> <thead> <tr> <th colspan="3">Data Log File 1/3</th> </tr> <tr> <th>FILENAME</th> <th>CH1</th> <th>CH2</th> </tr> </thead> <tbody> <tr> <td>>2020-JAN-04_20-59-00</td> <td>PInt</td> <td>mA</td> </tr> <tr> <td>2020-JAN-04_20-59-01</td> <td>PInt</td> <td>mA</td> </tr> <tr> <td>2020-JAN-04_20-59-02</td> <td>PInt</td> <td>mA</td> </tr> <tr> <td>2020-JAN-04_20-59-03</td> <td>PInt</td> <td>mA</td> </tr> <tr> <td>2020-JAN-04_20-59-04</td> <td>PInt</td> <td>mA</td> </tr> <tr> <td>2020-JAN-04_20-59-05</td> <td>PInt</td> <td>mA</td> </tr> <tr> <td>2020-JAN-04_20-59-06</td> <td>PInt</td> <td>mA</td> </tr> </tbody> </table> <p>04 MAY 2022 14:28 </p>	Data Log File 1/3			FILENAME	CH1	CH2	>2020-JAN-04_20-59-00	PInt	mA	2020-JAN-04_20-59-01	PInt	mA	2020-JAN-04_20-59-02	PInt	mA	2020-JAN-04_20-59-03	PInt	mA	2020-JAN-04_20-59-04	PInt	mA	2020-JAN-04_20-59-05	PInt	mA	2020-JAN-04_20-59-06	PInt	mA	<p>Select OK to confirm.</p>
Data Log File 1/3																													
FILENAME	CH1	CH2																											
>2020-JAN-04_20-59-00	PInt	mA																											
2020-JAN-04_20-59-01	PInt	mA																											
2020-JAN-04_20-59-02	PInt	mA																											
2020-JAN-04_20-59-03	PInt	mA																											
2020-JAN-04_20-59-04	PInt	mA																											
2020-JAN-04_20-59-05	PInt	mA																											
2020-JAN-04_20-59-06	PInt	mA																											

9.6.3.2 To delete all Data Log files

<p>Step 1</p>		<p>Select FILES from the Data Log screen.</p>																								
<p>Step 2</p>	 <table border="1" data-bbox="263 851 813 1332"> <thead> <tr> <th>FILENAME</th> <th>CH1</th> <th>CH2</th> </tr> </thead> <tbody> <tr> <td>>2020-JAN-04_20-59-00</td> <td>PInt</td> <td>mA</td> </tr> <tr> <td>2020-JAN-04_20-59-01</td> <td>PInt</td> <td>mA</td> </tr> <tr> <td>2020-JAN-04_20-59-02</td> <td>PInt</td> <td>mA</td> </tr> <tr> <td>2020-JAN-04_20-59-03</td> <td>PInt</td> <td>mA</td> </tr> <tr> <td>2020-JAN-04_20-59-04</td> <td>PInt</td> <td>mA</td> </tr> <tr> <td>2020-JAN-04_20-59-05</td> <td>PInt</td> <td>mA</td> </tr> <tr> <td>2020-JAN-04_20-59-06</td> <td>PInt</td> <td>mA</td> </tr> </tbody> </table>	FILENAME	CH1	CH2	>2020-JAN-04_20-59-00	PInt	mA	2020-JAN-04_20-59-01	PInt	mA	2020-JAN-04_20-59-02	PInt	mA	2020-JAN-04_20-59-03	PInt	mA	2020-JAN-04_20-59-04	PInt	mA	2020-JAN-04_20-59-05	PInt	mA	2020-JAN-04_20-59-06	PInt	mA	<p>Select the 'double' trash icon on the Data Log summary screen.</p>
FILENAME	CH1	CH2																								
>2020-JAN-04_20-59-00	PInt	mA																								
2020-JAN-04_20-59-01	PInt	mA																								
2020-JAN-04_20-59-02	PInt	mA																								
2020-JAN-04_20-59-03	PInt	mA																								
2020-JAN-04_20-59-04	PInt	mA																								
2020-JAN-04_20-59-05	PInt	mA																								
2020-JAN-04_20-59-06	PInt	mA																								
<p>Step 3</p>		<p>Select OK to confirm.</p>																								

9.7 How to transfer a Data Log file

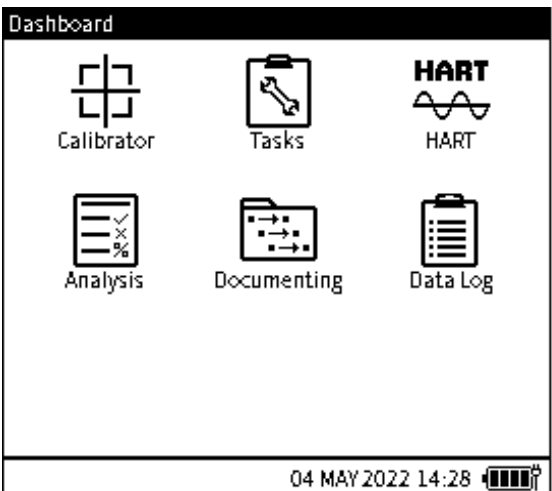
Data Log files can be copied from the DPI 610E internal memory to an external device. This device can either be a micro-USB memory stick or an external PC.

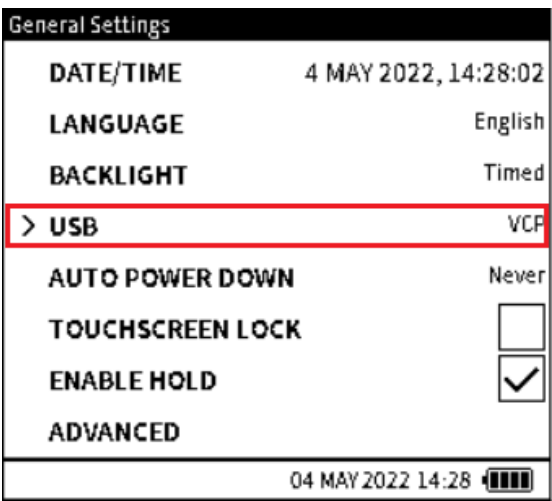
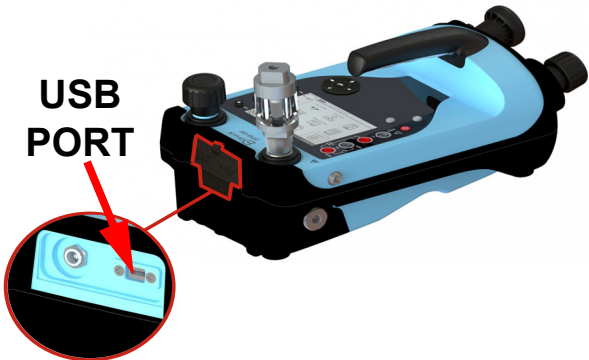
Step 1		<p>Select the Settings icon  on the Dashboard. Press the Home button  if necessary, to show the Dashboard. To select, tap on the icon or press the softkey on the right of icon.</p>
Step 2		<p>The General Settings screen appears. Select the USB option. Push a micro-USB memory stick into the USB port located behind a rubber flap at the end of the instrument. Use a USB port converter if only a standard USB memory stick is available. If the Data Log file is to be copied to the memory of an external PC, connect a micro-USB data cable to the USB port.</p> 

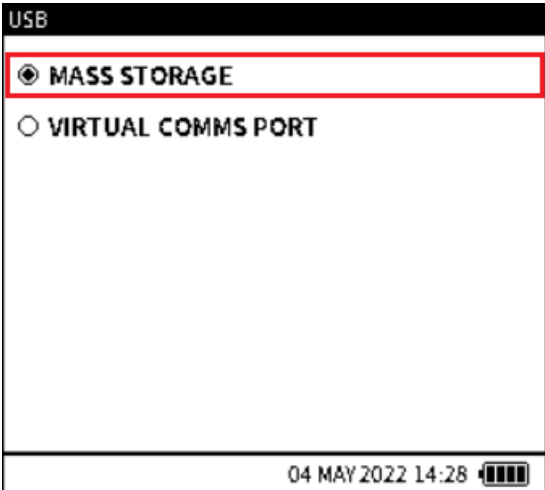
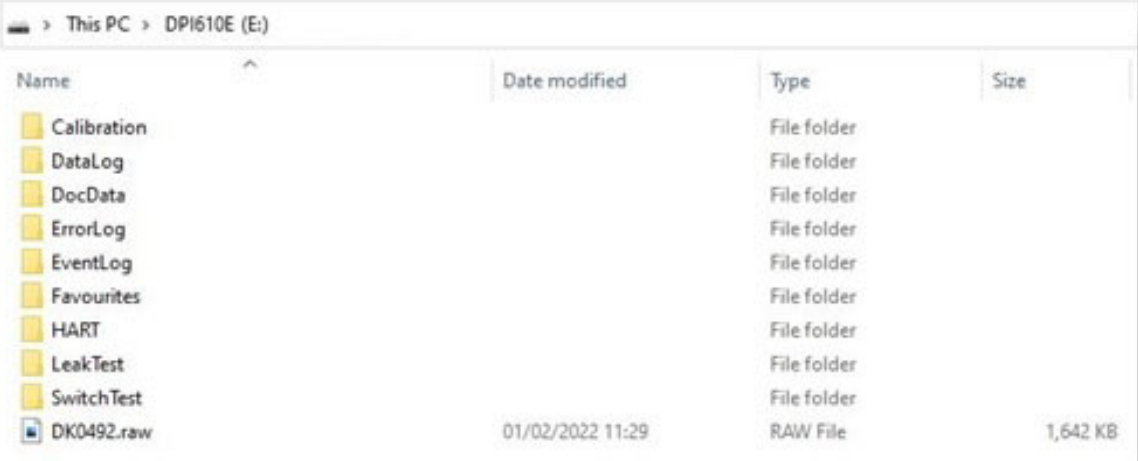
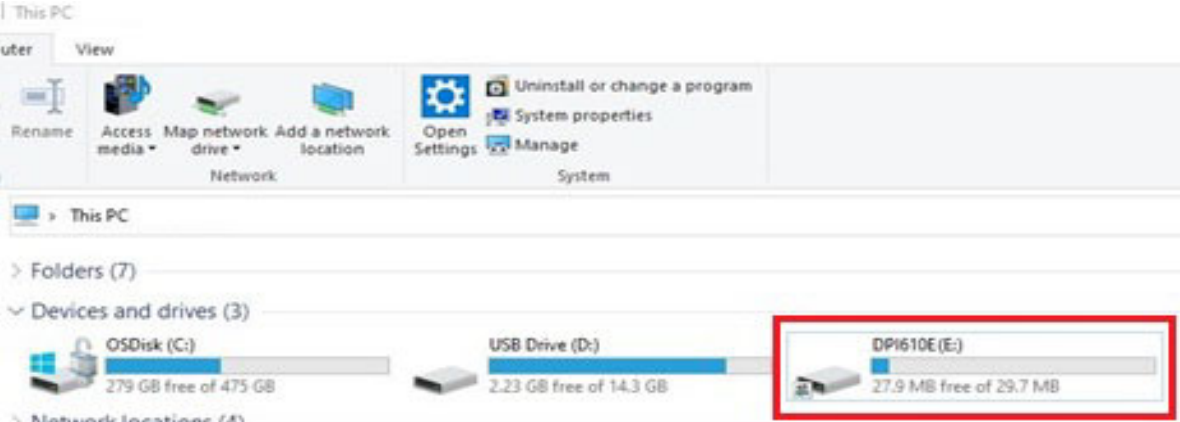
<p>Step 4</p>		<p>Click on MASS STORAGE to select the option.</p> <p>Select ✓ to confirm the selection.</p>
<p>Step 5</p>	<p>If using a micro-USB memory stick: Copy the Data Log file from the DPI 610E internal memory location into the micro-USB storage drive. See Section 9.6.1 on page 167 for how to select file.</p>  <p>If using a micro-USB data cable: Connect the DPI 610E to the PC using the data cable.</p> <p>Note: You may have to request for USB exception via Service Catalog: http://servicecatalog.ent.bhicorp.com/usm/wpf?Node=icquinode.catalogitemdetails&Args=11846&ObjectID=11846&NspPath=&searchIn=&searchInstr=Entire%20Catalog</p> <p>The PC should automatically detect the the DPI610E which should appear as a Mass Storage drive (default name is DPI610E).</p> 	
<p>Step 6</p>	<p>When the copy process is confirmed, remove the USB memory stick or cable from the DPI 610E.</p>	

10. Analysis

10.1 Overview

The **Analysis** application takes readings from the two channels, to calibrate the transfer characteristic of the device being tested. One channel is set as the Input channel and the other channel is set as the Output channel.

The Input channel provides a measure of the input signal to the device under test (DUT). For example, if calibrating a pressure transmitter, the Input channel could be the DPI 610E Internal Pressure which measures the supplied pressure to the DUT.

The Output channel measures the output signal from the DUT. If calibrating a 4 to 20 mA process transmitter, the output channel would be the Current Measure.

By default, the Analysis application uses the functions and measurement units set up in CH1 as the Input and the function set up in CH2 as the output. This means that the required functions for analysis have to be selected in the Calibrator screen before starting the Analysis application (Refer to “Calibrator Tasks” on page 63 for more details.)

There is however the option to toggle between Input and Output selection for both functions.

For the Analysis application to run, both channels must be enabled with a valid function i.e. any function option except “None”.

At each test point value, the Analysis function calculates the difference of each Output channel to the ideal transfer characteristic and compares this to a user specified tolerance limit. This deviation is calculated and can be displayed in different user defined formats. In addition, the tolerance test result is shown as a Pass or Fail.

10.2 Analysis Setup

Select the **Analysis** icon on the Dashboard to start the Analysis application.

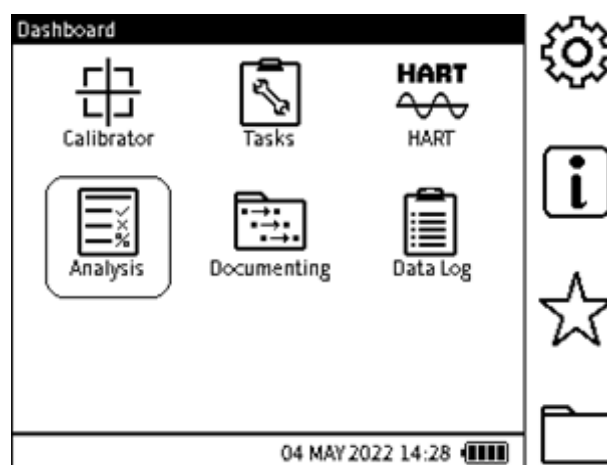

Figure 10-1: Instrument Dashboard

10.3 Function

The **Analysis Setup** screen shows the selected **CH1** and **CH2** calibrator functions and units. The required functions needed in the Analysis application, need to be selected in the Calibrator application prior to running Analysis. For example, to run analysis on a pressure transmitter with a 4 to 20 mA output, **CH1** can be configured to **INT Pressure** and **CH2** to **Current Measure** (with 10/24 V power if required). Select the required types of measurement units.



Analysis: Setup		INPUT	OUTPUT
FUNCTION	INT Pressure	← Current	
UNITS	bar	mA	
START	> 0.0000	0.0000	
END	1000.0000	1000.0000	
LINEARITY	Linear		
ERROR TYPE	% Span		
TOLERANCE	0.100%		
04 MAY 2022 14:28 			

Figure 10-2: Analysis Function screen

The **INPUT** and **OUTPUT** functions can be interchanged using the toggle  softkey.

10.3.1 START/END Values

The measurement range for the input and output channels is defined by setting a **START** (Low) and **END** (High) value for each channel. The default values displayed are usually the negative and positive full-scale values of the related function. When Current Measure is selected, the default **START** and **END** values, are 4 and 20 mA. When entering **START** and **END** values, any value entered which falls outside the full-scale limits of the selected function will be rejected.

10.3.2 LINEARITY

The transfer characteristic from **INPUT** signal to the **OUTPUT** signal can be either:

- Linear - when the transfer characteristic is a directly proportional relationship.
- Square Root - when the transfer characteristic has a square-root relationship. This is commonly found in flow sensors.

The default mode is Linear.

Chapter 10. Analysis

10.3.3 ERROR TYPE

The error or deviation from the transfer characteristic can be calculated and expressed in any of the following options:

- % Span - a percentage of the Output signal span.
- % Full Scale - a percentage of the Output signal full-scale.
- % Reading - a percentage of the Output signal reading.
- Fixed - absolute measurement units of the Output signal.

The default selection is %Span.

10.3.4 TOLERANCE

The tolerance or test limit values for the calculated result error or deviation from the transfer characteristic, can be defined using this option. The tolerance value is expressed either as a % or as an absolute or fixed measurement unit e.g., mA. This is reliant on the Error type selected. The default tolerance value is 0.1%.

10.4 Analysis Function

Set the **Input** and **Output** channel and error analysis parameters as described in “Analysis Setup” on page 174.

Select the **Play**  button to start.

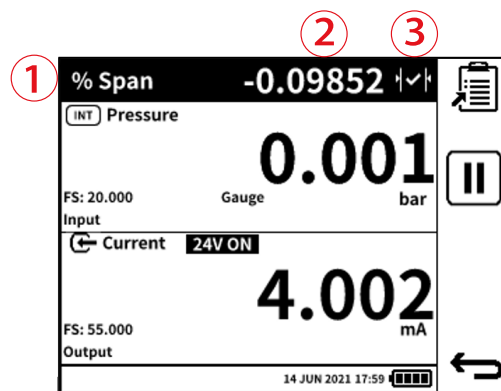

The **Analysis** main screen window displays the following:

1. The deviation tolerance type.
2. The error/deviation value of the output channel from the ideal transfer characteristic.
3. A live indication of the tolerance result status icon which is one of the following:

PASS  - the currently measured output value lies within the specified tolerance limits.

FAIL  - the currently measured output value lies outside the specified tolerance limits.

The screen is in two sections. Each section displays information for a channel and identified as either the **Input** or **Output** channel.

To test the full range of the of the Device Under Test (DUT):

- Step the input signal value through its range. In the example screen shot, step the internal pressure generated by using the DPI 610E pump from the lower range of the DUT to the full-scale pressure value.
- At each setpoint step, check the Analysis status at the top of the screen for the deviation.
- When the test is complete, exit the Analysis screen using the **Back** button.

10.4.1 DATA LOGGING within Analysis

Checking a DUT in the Analysis application can be documented using the Datalog. To use this feature, select the **Data Log** softkey. For more information on **Data Log**, see Chapter 9 on page 155. When using **Data Log** in the Analysis application, only the **Key Press** trigger mode is available.

- Enter the required Data Log file name
- Select the **Start** softkey to proceed
- At each **Setpoint** step (or when desired), press the “Add Datapoint”  softkey to capture the current analysis data displayed by the screen.
- When the testing is complete, press the **Back** button to exit the Datalog and Analysis application.

Datalog files can be accessed via the **Data Log** application (Refer to “Data Log” on page 155).

11. Documenting

11.1 Overview

Use the Documenting application to do documented calibration of Device Under Test (DUT) equipment or of assets using defined test procedures.

Test procedures can be created within the Documenting application and stored for future use.

When test procedures are used to calibrate DUTs, the test details and results of the calibration are saved in DPI 610E memory. This data can also be transferred to a PC for further analysis or post calibration tasks.

A calibration certificate template wizard is provided by Druck to transform the data into a professional looking format for printing or filing purposes.

11.1.1 How to start the Documenting application

	<p>Select the Documenting softkey from the Dashboard. This will show the Procedures screen.</p>
--	---







11.2 INTERNAL PROCEDURES

11.2.1 How to select the INTERNAL PROCEDURES mode

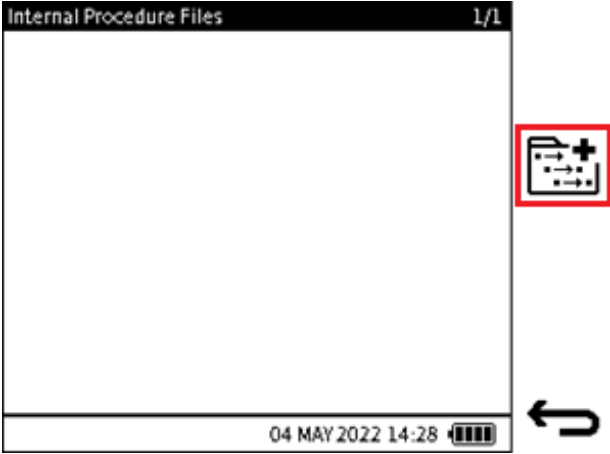
Only the **INTERNAL PROCEDURES** mode is available in the current software release. There will be a **REMOTE PROCEDURES** mode in the future.

<p>Step 1</p>		<p>To view, create or run internal procedures, select the INTERNAL PROCEDURES softkey from the Procedures screen. This will show a list of available internal procedure files.</p>
---------------	--	--

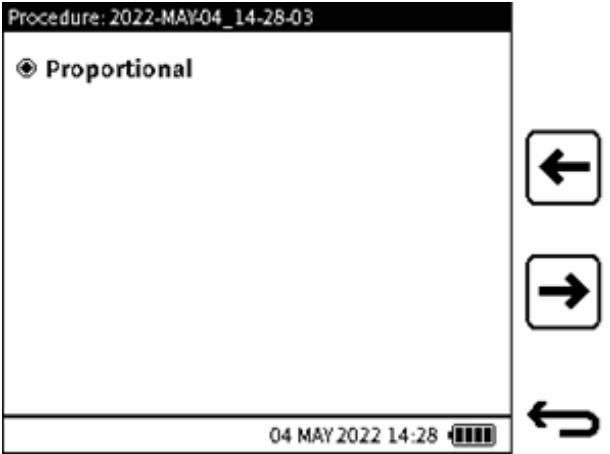
11.2.2 How to create an Internal Procedure

<p>Step 1</p>		<p>This screen appears after INTERNAL PROCEDURES has been selected from the Procedures screen (see Section 11.2.1 on page 178). The Internal Procedure Files screen shows the list of available internal procedure files. The number of Assets on which each procedure has been run and calibration results saved will also be shown alongside the Procedure file name. See Section 11.2.3 on page 186 on how to run a test procedure. If no procedures have been created or saved, the Internal Procedures screen will be blank.</p> <p>Select the New Procedure  Softkey to start the Procedure Creation wizard.</p>
<p>Step 2</p>		<p>Enter a filename for the test procedure or use the default filename which is based on the system date and time stamp. Note: A maximum of 20 characters is supported for the filename.</p> <p>Select the Tick  softkey to confirm and show the Create Procedure screen.</p>
<p>Step 3</p>		<p>Select the type of calibration required. Proportional is the default option.</p> <p>Press the Next  softkey to proceed or the Previous  softkey to go back one step.</p>

Chapter 11. Documenting

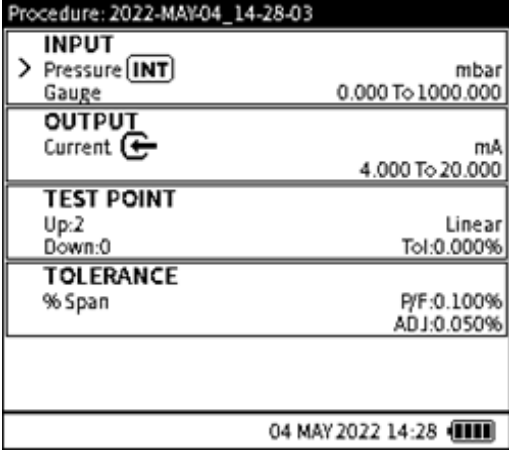
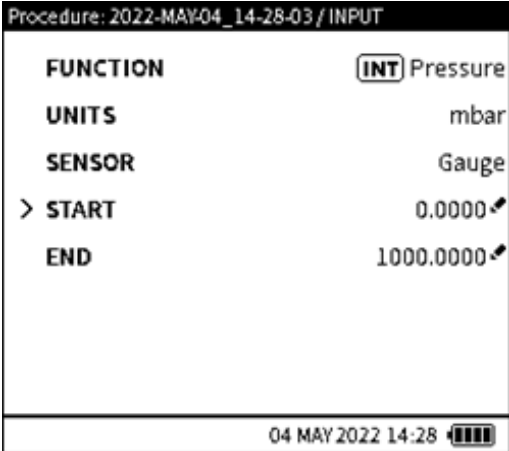
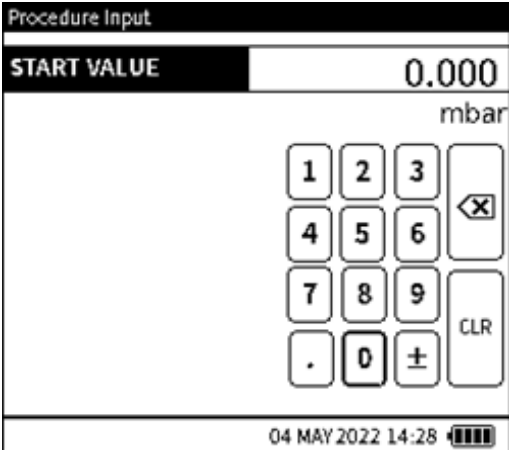
		<p>This is the test procedure setup screen which has the following sections which are critical to the procedure:</p> <ol style="list-style-type: none"> 1. Input. 2. Output. 3. Test Points. 4. Tolerance. <p>These details are auto populated based on the current Calibrator configuration, parameters configured in the Analysis application setup and other default settings. Details of each section is given the following steps.</p>
<p>Step 4</p>		<p>INPUT: The input refers to the test input signal to the Device Under Test (DUT). The input function type, the sensor type (where applicable), the range, and the measurement units all appear in this section.</p> <p>By default, the Function (and hence Sensor type) set up in CH1 is configured as the input with the selected Units. These are read-only and not editable in the procedure creation wizard. If any changes are required, these must be done in Calibrator prior to using the Documenting application. The input range is auto populated by default with the full sensor range related to the Function. Only the range can be edited and must be within the full sensor range. Set the START and END values of the input range if different to the values displayed.</p> <p>Note: It is possible using the Toggle softkey to swap the Input and Output functions i.e., use the original Input function as the Output function and vice versa.</p>
		

Step 4
Cont'd



OUTPUT: The Output refers to the output signal from the Device Under Test (DUT). By default, the **FUNCTION** (and hence **SENSOR** type) set up in **CH2** is configured as the output with the selected **UNITS**. These are read-only and not editable in the procedure creation wizard. If any changes are required, these must be done in Calibrator prior to using the Documenting application. The output range is auto populated by default with the full sensor range related to the Function. Only the range can be edited and must be within the full sensor range. Set the **START** and **END** values of the input range if different to the values displayed.

Note: It is possible using the Toggle softkey to swap the Input and Output functions i.e., use the original Input function as the Output function and vice versa.

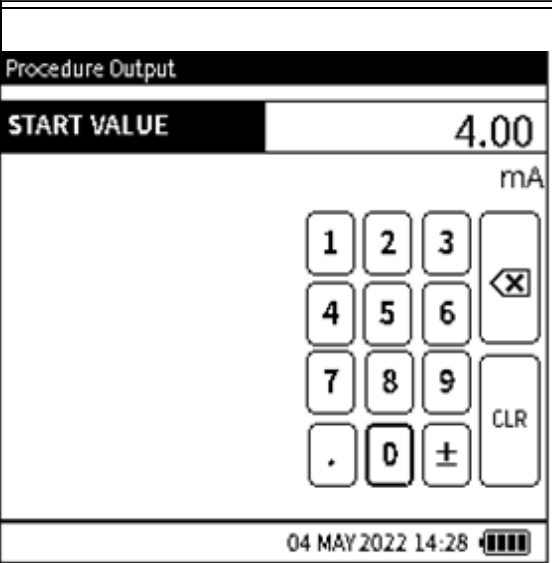

TEST POINTS: This refers to input points at which the device under test (DUT) will be tested and its calibration data recorded.

Points Up & Points Down
The number of calibration points must be specified within the specified Input range. This can be specified as **POINTS UP** i.e. direction from **START** range value to **END** range value or/and **POINTS DOWN** i.e. direction from **END** range value to **START** range value. The default setting is 2 Points Up and 0 Points Down. This means there will be two test points - the first test point will be the Input Start value and the second will be the Input End value.

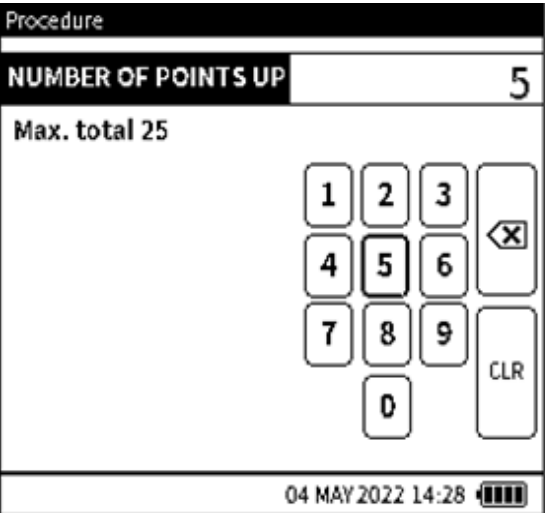
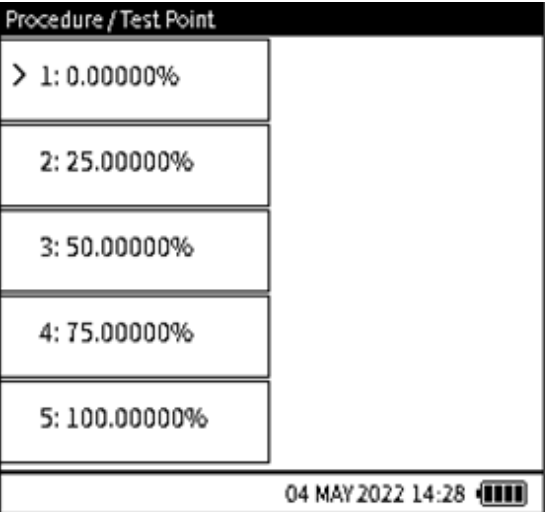
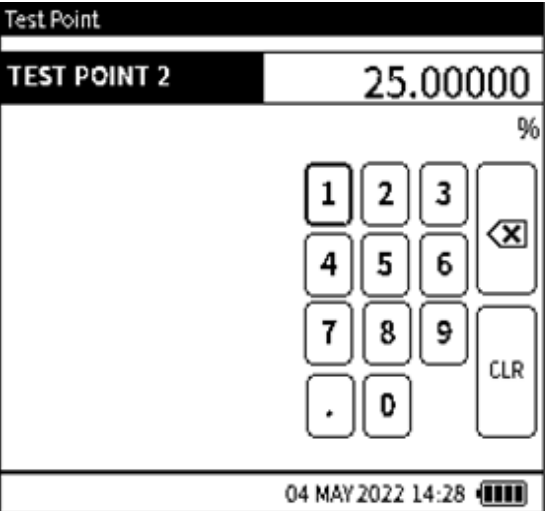

Chapter 11. Documenting

		<p>Set the desired number of points UP and DOWN if different from the displayed. Either UP or DOWN values must be between 0 and 25. Note: There must be a minimum of 2 points UP and maximum of 25 test points in total (i.e. UP and DOWN combined). For each Points UP and DOWN setting, the resulting test point values are calculated and can be viewed by selecting the View softkey.</p>
<p>Step 4 Cont'd</p>		<p>In the TEST POINTS screen, it is possible to manually adjust each test point if required by selecting the relevant test point box and changing the value. As shown in the screen below.</p>
		

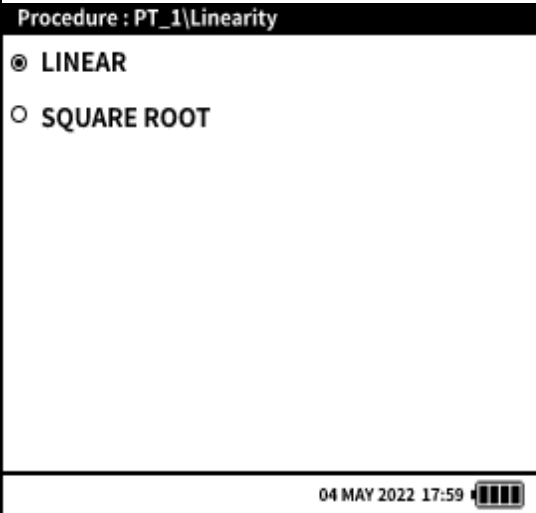
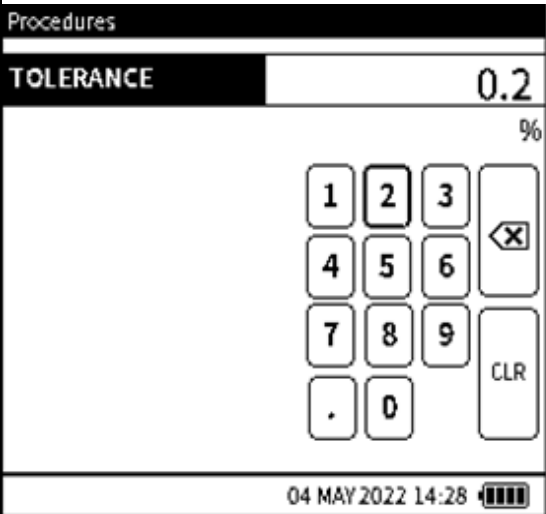
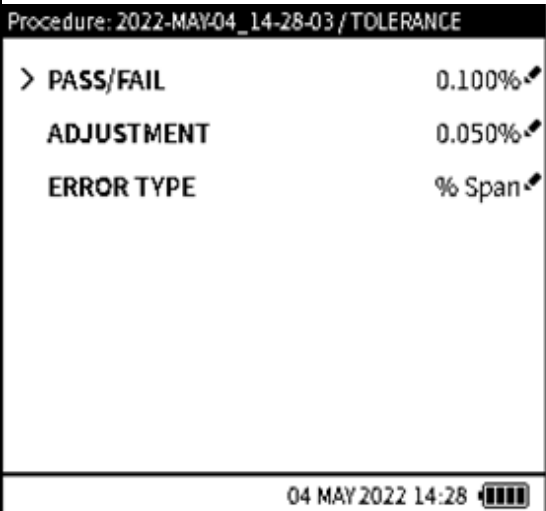
		<p>Linearity – the relationship between the input and output can also be specified i.e., either Linear or Square Root transfer function. The default is Linear.</p>
<p>Step 4 Cont'd</p>		<p>TOLERANCE – this is the maximum deviation or permissible error margin for each input test point in the calibration. It is specified as a percentage of the Input range. The default test point tolerance value is 5% and can be changed if required.</p>
		<p>TOLERANCE: This section refers to the deviation on the output signal or result with respect to each input signal setpoint applied. PASS/FAIL (or Result Tolerance) (P/F): This sets the maximum deviation that determines if the result (output) at each test point is within specification (PASS) or out of specification (FAIL). It is expressed as a % of the output or in fixed measurement units depending on the tolerance type. The default value is 0.1% (based on% FS).</p>

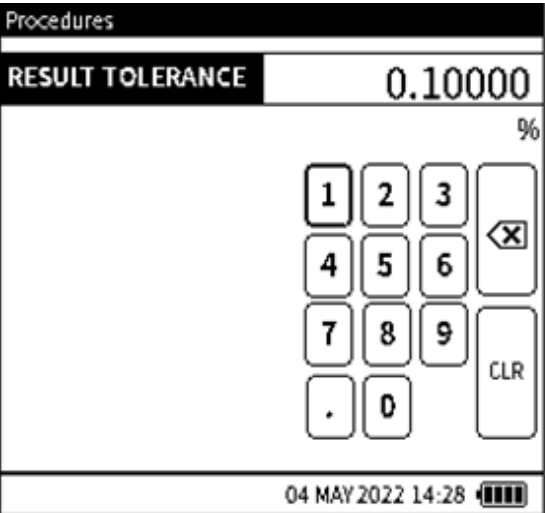
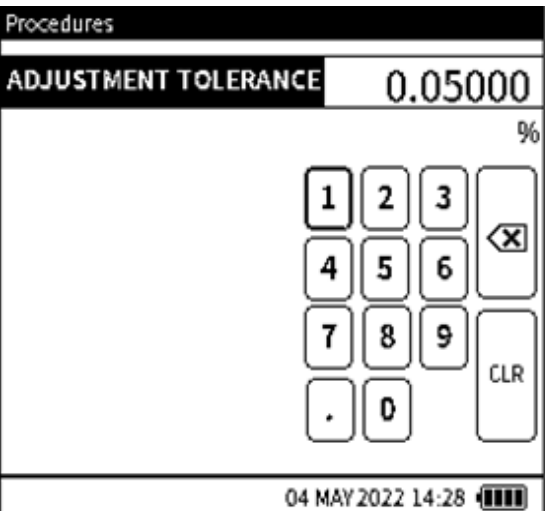
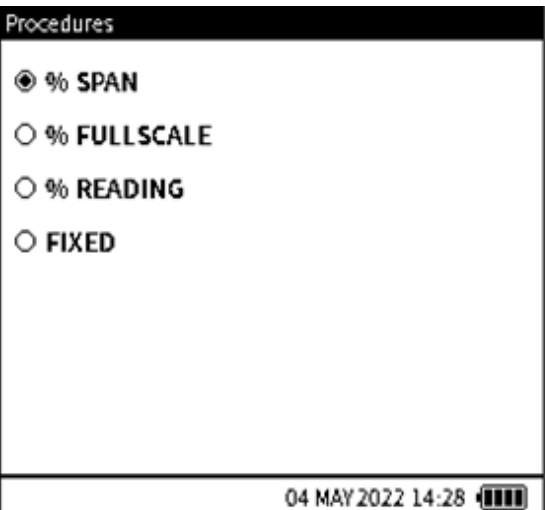
		<p>ADJUSTMENT (Tolerance): This sets the maximum deviation within the PASS/FAIL tolerance which indicates that the Device Under Test (DUT) is close to out of specification limits. Hence the ADJUSTMENT tolerance value must be less than the PASS/FAIL tolerance value to be captured. If an ADJUSTMENT tolerance is not required, the adjustment tolerance value can be equal to the PASS/FAIL tolerance. The default value is 0.07% (based on% FS).</p>
<p>Step 4 Cont'd</p>		<p>This screen is for the ADJUSTMENT value in the Procedure: PT_1/Tolerance screen on the previous page.</p>
		<p>Use this screen to set the way the maximum deviation is calculated. The four options for this calculation are given by the graph in the next row.</p>

<p>Step 4 Cont'd</p>		<p>ERROR TYPE (Tolerance): this specifies the way the maximum deviation is calculated and expressed. Options include:</p> <ul style="list-style-type: none"> • %FS (Percent of Full-scale) • %Span (Percent of Span) • %Percent of reading) • %Fixed (Measurement units). <p>See Section 10.3.3 on page 176 for more details. The default is % Full-scale (%FS).</p>
<p>Step 5</p>		<p>When the details of the test are completed, press the Save softkey to save the procedure. The test procedure after being saved, becomes immediately available for use.</p>

Chapter 11. Documenting

11.2.3 How to start a Test Procedure

Step 1		<p>Once the test procedure has been saved successfully, it is available to be used immediately by selecting the Proceed softkey.</p>
--------	--	---

Step 2		<p>The test procedure can also be selected from the Internal Procedure Files screen. Select a test procedure, for example, File 2, by tapping in the row or using the Navigation pad.</p>
--------	--	---



11.2.4 How to delete a Test Procedure

	<p>Tap or use the Navigation pad buttons to select the row that has the test procedure file name: in this example, File 2. Tap or use the softkey to select the Erase icon, to delete the file name from the list.</p> <p>Note: When a Test Procedure is deleted, any asset data saved as part of the procedure file will also be deleted.</p>
--	---

11.2.5 Additional Data Required

When a test procedure has been created and saved in DPI 610E memory, additional data is required before a test procedure can be activated. This data is the Device Under Test (DUT) details, plus the Environment and User ID details that apply to a specific test procedure.

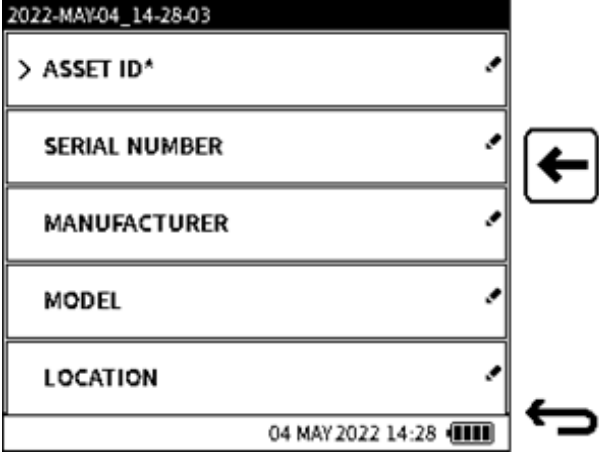
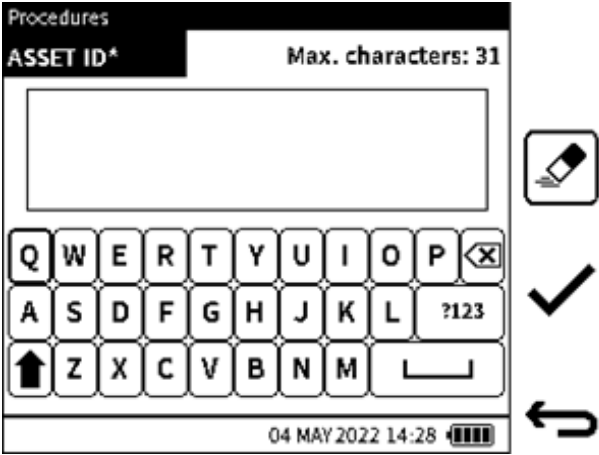
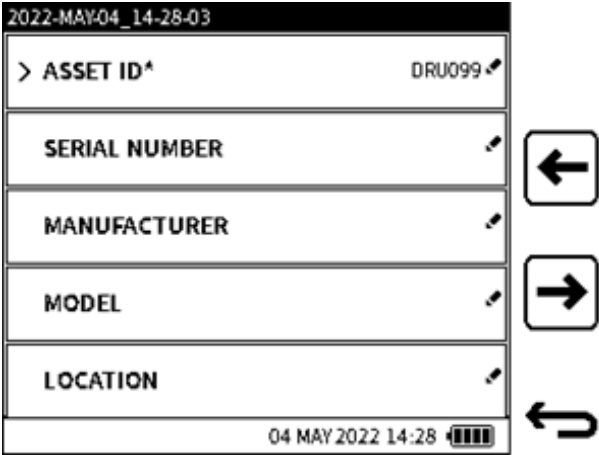
11.2.5.1 DUT data



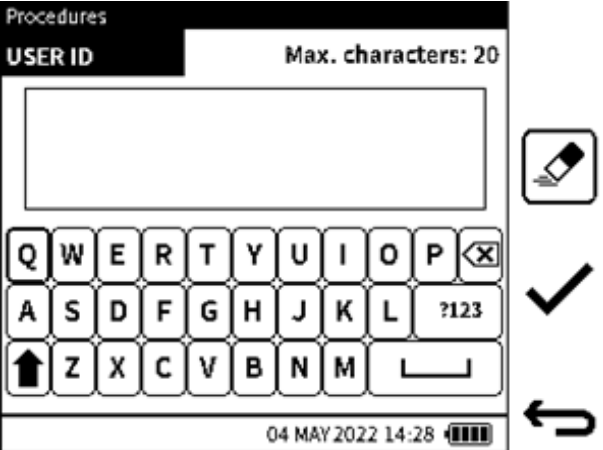

Step 1		<p>Enter additional data into this screen. One row is mandatory the others are optional.</p> <p>ASSET ID (Mandatory) – This is a unique tag or device reference that is given to the asset or DUT. This ID will be used as the default result filename when the calibration is completed. Maximum number of characters: 31.</p> <p>SERIAL NUMBER (Optional) – the serial number of the asset or DUT. Leave blank if not known. Maximum number of characters: 50</p> <p>MANUFACTURER (Optional) – the manufacturer of the asset or DUT. Maximum number of characters: 30.</p> <p>MODEL (Optional) – the model’s name or number of the asset or DUT. Maximum number of characters: 30.</p> <p>LOCATION (Optional) – the physical location of the asset or DUT. Maximum number of characters: 50.</p>
		
		<p>When the required fields have data in them select the Next  screen icon to show the Environment screen.</p>

11.2.5.2 Environment and User ID data

Step 1		<p>If required, enter additional data into this screen.</p> <p>AMBIENT TEMPERATURE – Enter the ambient temperature value where the test is being done. Temperature units available are °C or °F. Use the Toggle softkey to switch between these units. The unit conversion will be done automatically: 20°C is the default ambient temperature value. Any value entered must be between -100 to +100 °C (-148 to 212 °F).</p> <p>AMBIENT PRESSURE – Enter the ambient pressure value (or pressure of the day) where the test is being done. Pressure units available are mbar, psi or in Hg. Use the Toggle softkey to switch between these units. The unit conversion will be done automatically. For DPI610E pneumatic variants, the default ambient pressure value is obtained from the internal barometer sensor. On hydraulic variants, the default ambient pressure value is 1013 mbar. Any value entered must be between 800 to 1200 mbar (11 to 18 psi or 23 to 36 in Hg).</p> <p>AMBIENT HUMIDITY – Enter the ambient humidity value where the test is being done. The default value is 70%. Any value entered must be between 0 and 100%.</p>

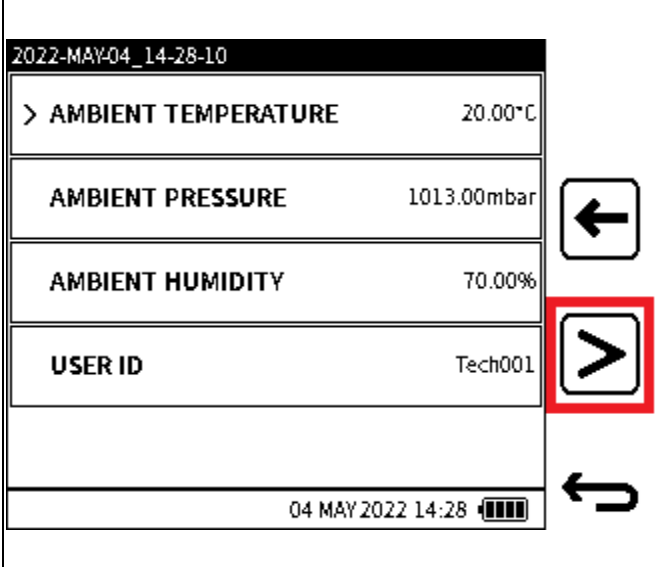
<p>Step 1 Cont'd</p>		<p>USER ID – enter User ID of the person doing the test procedure. Maximum number of characters: 20.</p> <p>When the required fields have data in them select the Back ↩ icon to show the Environment screen.</p>
--------------------------	---	--

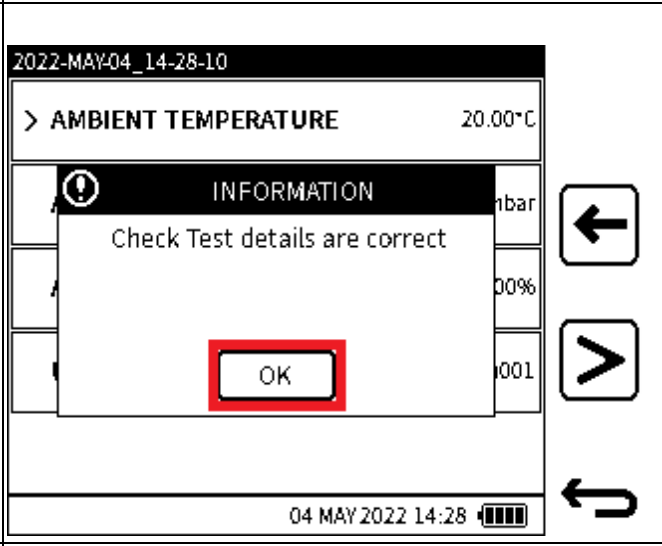
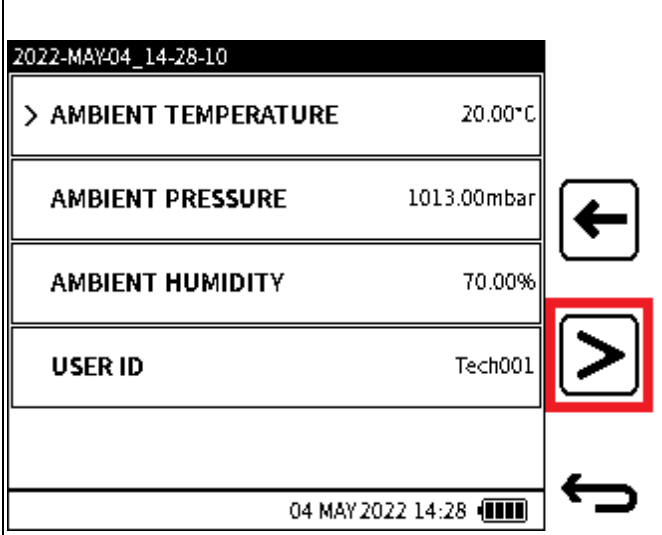
11.2.6 How to proceed after input of additional data

Step 1		<p>After the Environment and User ID data have been entered, select the Proceed  softkey to continue.</p>
Step 2		<p>A popup message will appear to prompt the user to check all the details are correct. Select the OK button to clear the message. This provides a checkpoint where the user may go back and check all the details of the test procedure are correct.</p>
Step 3		<p>When ready to start the test, press the Proceed  softkey to continue.</p>

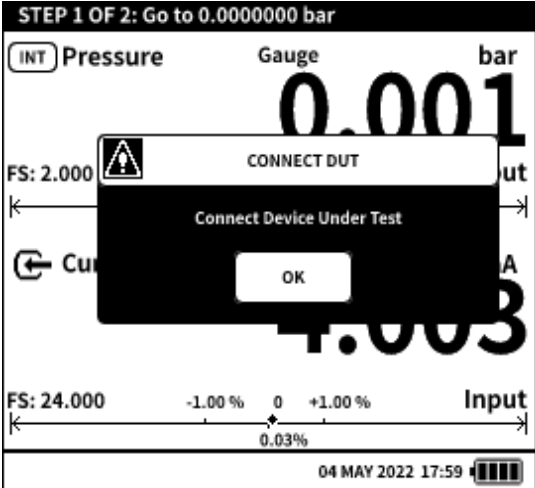
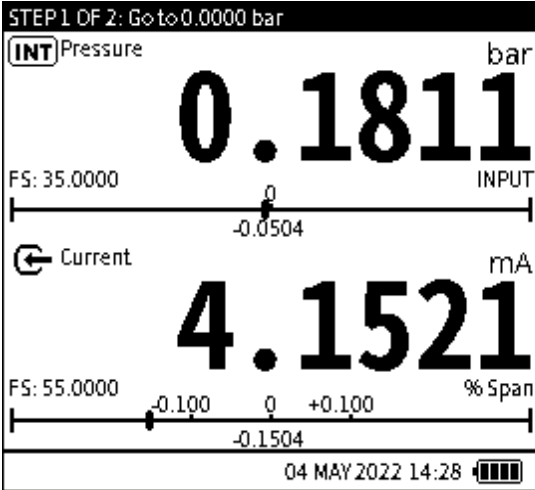



<p>Step 4</p>		<p>When the test configuration is complete, connect the Device Under Test (DUT) if not done already. A popup message will appear, to prompt the user. Select OK only when the DUT has been connected successfully. The screen in Step 5 will appear.</p>
<p>Step 5</p>		<p>The DPI 610E performs a verification check to make sure the test requirements and the DUT connected match. At this stage any discrepancies will be flagged with the relevant popup message displayed. For example, if a pressure sensor (DUT) is connected which is a different sensor type to that which the test specifies. Another example is if the DUT connected has an incompatible pressure range to that which is specified for the test.</p>

The next section describes the components of the **Documenting Main** screen.

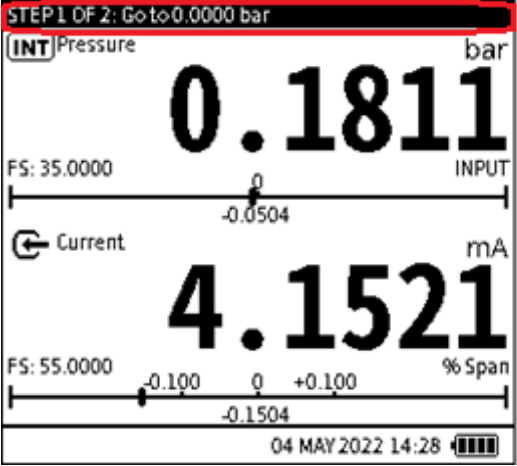
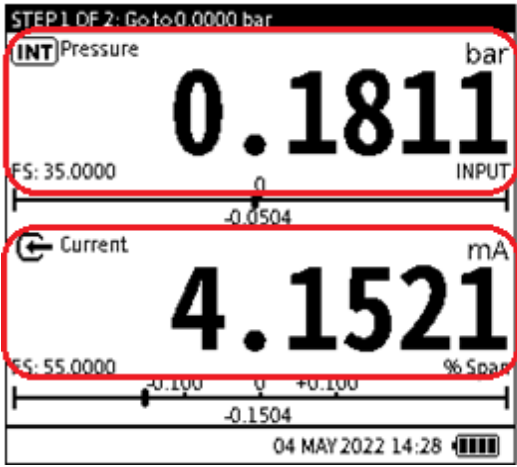
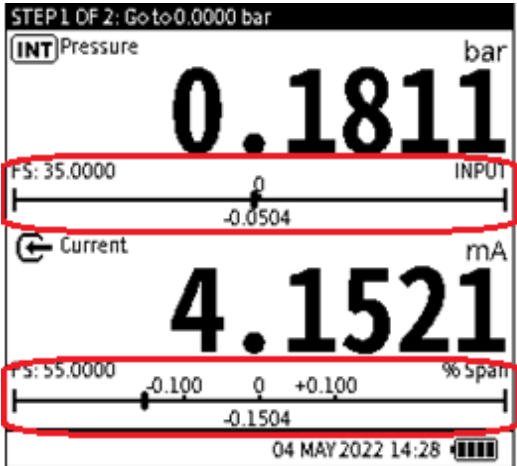

11.3 The Documenting Main Screen



This section describes the different elements of the **Documenting Main Screen**.

 <p>The screenshot shows the Documenting Main Screen. At the top, the title bar reads "STEP 1 OF 2: Go to 0.0000 bar". Below this, the input channel is labeled "INT Pressure" and shows a reading of "0.1811 bar". The full scale (FS) is "35.0000". Below the input channel, the output channel is labeled "Current" and shows a reading of "4.1521 mA". The full scale (FS) is "55.0000" and the error type is "% Span". The error and tolerance indicator shows a zero mark with "-0.100" on the left and "+0.100" on the right, and a calculated live error of "-0.1504" below the zero mark. The date and time "04 MAY 2022 14:28" and a battery icon are at the bottom. On the right side, there are icons for a clipboard, a pause button, a wrench, and a refresh button.</p>	<p>The title bar contains information about:</p> <ul style="list-style-type: none"> • Number of steps the test requires and what the current step is e.g., Step 1 of 2. • The input test point value to apply e.g., Go to 0.000 bar • Completion status at the end of the test.
 <p>The screenshot is identical to the one above, but with red boxes highlighting the input channel (0.1811 bar) and the output channel (4.1521 mA).</p>	<p>The sensor information and readings for Input and Output. The top channel displays the Input information and the bottom channel, the Output. In the output section, the Error Type is displayed below the reading on the right side of the window.</p>
 <p>The screenshot is identical to the one above, but with red boxes highlighting the error and tolerance indicators for both the input and output channels.</p>	<p>Error and tolerance indicator is displayed for both the input and the output. The specified tolerance value is displayed on either side of the zero mark. This value is based on the Error Type and hence is expressed as a % unless the Fixed units Error type is selected in which case is expressed as the Output measurement units. The calculated live error is displayed below the zero mark both input and output channels. A marker is also displayed to indicate the approximate error value point with respect to the specified tolerance and tolerance line.</p> <p>Note: if the marker is not visible, check the error value as it most likely means the error is too large to be visible on the error and tolerance indicator.</p>

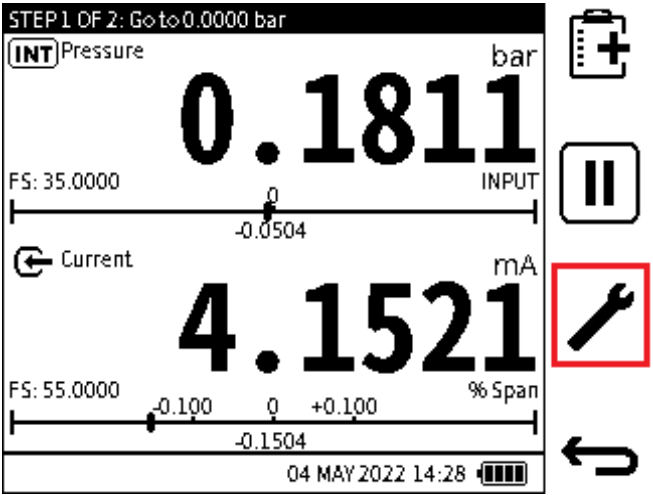
<p>STEP1 DF 2: Go to 0.0000 bar</p> <p>INT Pressure bar</p> <p>0.1811</p> <p>FS: 35.0000 INPUT</p> <p>-0.0504</p> <p>← Current mA</p> <p>4.1521</p> <p>FS: 55.0000 % Span</p> <p>-0.100 0 +0.100</p> <p>-0.1504</p> <p>04 MAY 2022 14:28</p>	   	<p>Select the Add Test Point  softkey to capture the datapoint.</p>
--	--	---

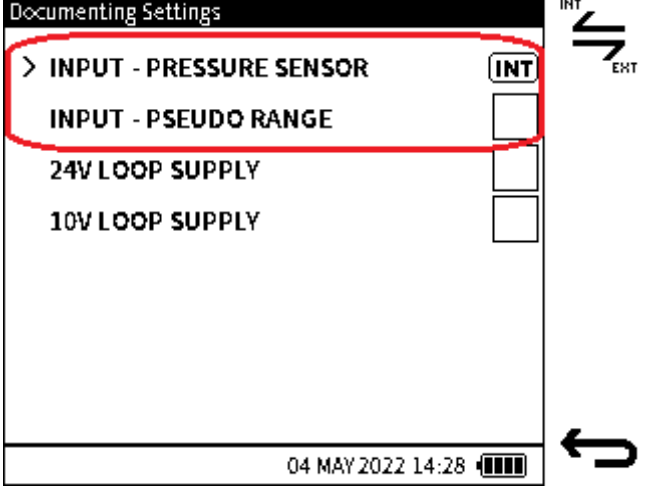
11.4 Documenting Settings

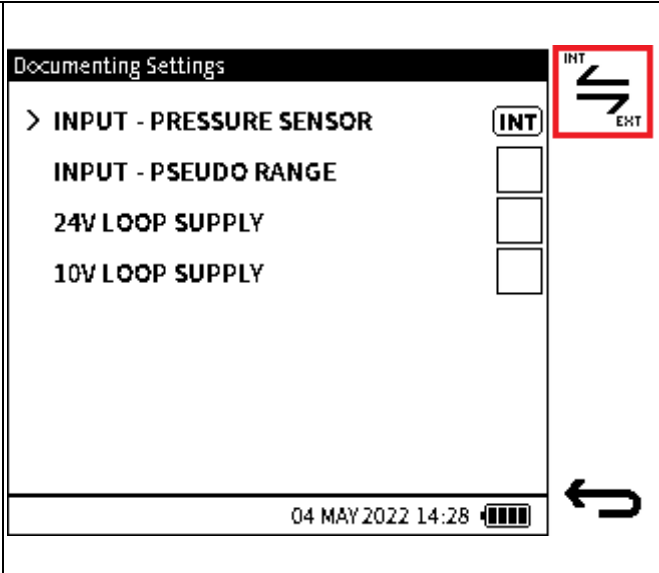
<p>Step 1</p>		<p>If additional test procedure setup is required before documenting begins, select the Setup  softkey.</p>
<p>Step 2</p>		<p>Pressure Sensor Type For pressure calibrations, if a different pressure sensor type is to be used from that which was used to create the test procedure, it is possible to change the sensor configuration to match. Note: This applies to the INT and EXT Pressure functions used as the Input or/and Output only. For example, if a gauge pressure sensor is specified in the test procedure and the available pressure sensor is an absolute pressure sensor, the absolute pressure sensor can be configured to pseudo gauge (pneumatic variants only) or sealed gauge (hydraulic variants only). To use PSEUDO RANGE, select the relevant pseudo-range option from the settings screen. The tick-box is ticked when enabled and unticked when disabled.</p>

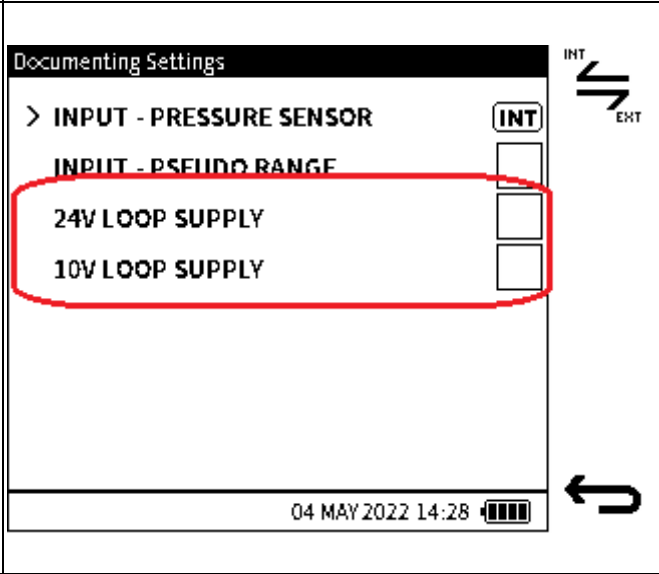

<p>Step 3</p>		<p>Pressure Sensor Function For pressure-to-pressure calibrations i.e., INT pressure and EXT pressure, the option to swap the assignments of the sensors as Input and Output using the Toggle  softkey. Care must be taken to make sure the sensor type and range are compatible with that specified in the test.</p>
<p>Step 4</p>		<p>10 V/24 V Power The option to enable the internal 10 V or 24 V power is also available in the Calibrator Tasks chapter (see Section 6.2.9 on page 88 menu). Select the required option from the settings screen. The tick-box is ticked when enabled and unticked when disabled.</p>

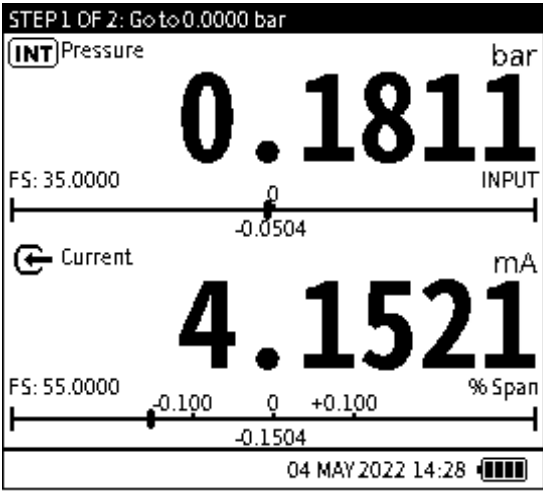
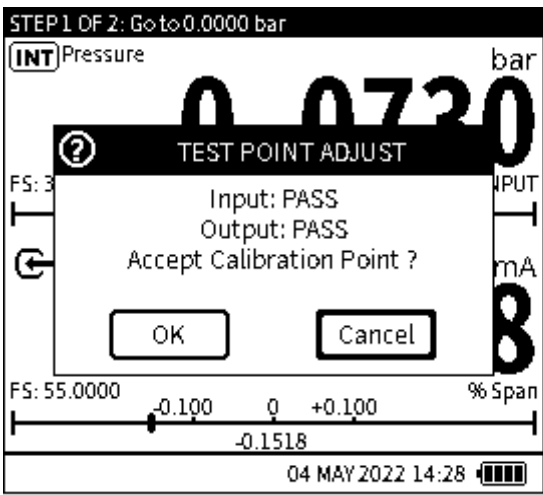
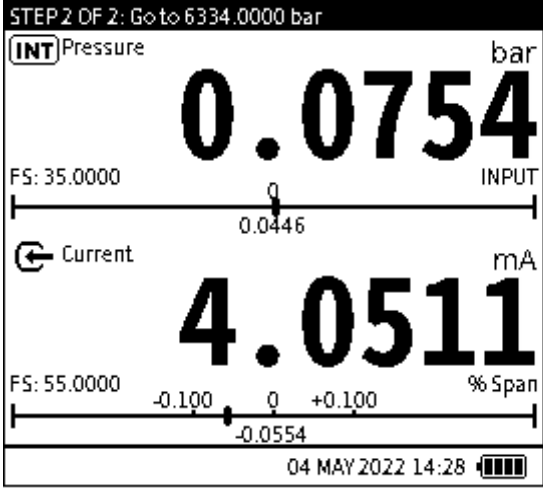
11.5 Example Testing Session

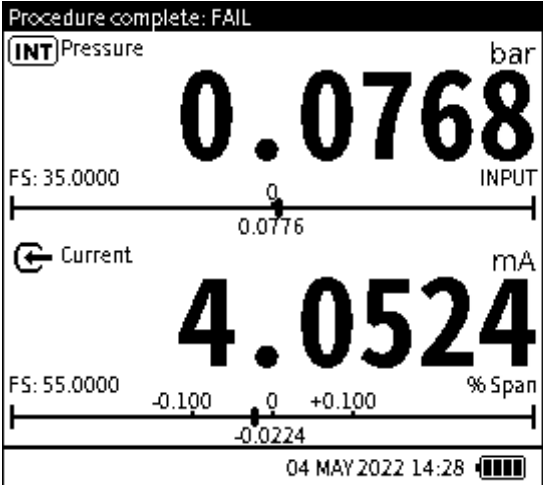
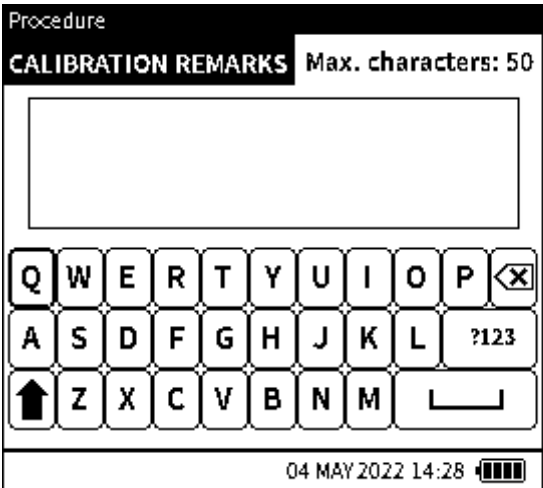
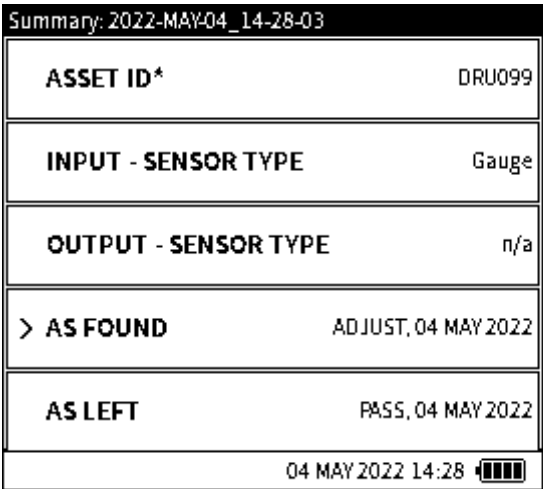



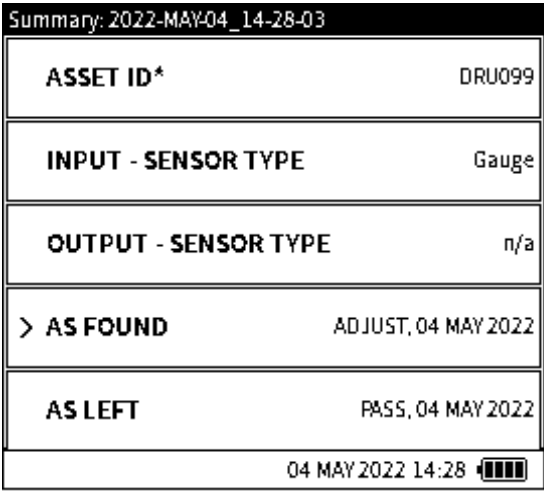
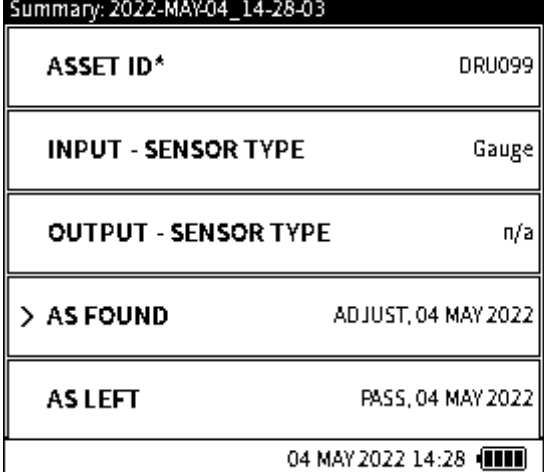

<p>Step 1</p>		<p>Using the step instructions in the title bar, go to (or input) the Step 1 setpoint value displayed. In this example, apply 0.0000 bar using the DPI 610E pump and/or volume adjuster. When the value is within the test point tolerance limits, select the Add Test Point softkey to capture the datapoint.</p>
<p>Step 2</p>		<p>A popup message window appears which shows the Pass/Fail status of both the input (test point) and the output (result) and requires confirmation to log the calibration data point. Select OK to accept and log the reading or Cancel to abort.</p>
<p>Step 3</p>		<p>Go to the next step setpoint as shown in the title bar and repeat the previous step. Repeat until all steps have been completed and logged.</p>

<p>Step 4</p>		<p>After the last calibration data point has been logged, the Tick softkey will replace the Add Test point softkey. The title bar will show Procedure complete. Select the Tick softkey to confirm completion of the calibration.</p>
<p>Step 5</p>		<p>The following screen is the CALIBRATION REMARKS screen. Enter any comments worth noting relating to the calibration procedure just completed. This step is optional, and the CALIBRATION REMARKS field can be left blank. Maximum number of characters: 50.</p> <p>Select the Save softkey to save the CALIBRATION REMARKS and continue.</p>
<p>Step 6</p>		<p>The next screen is the Procedure result summary screen. Details of the test procedure just completed are given.</p>

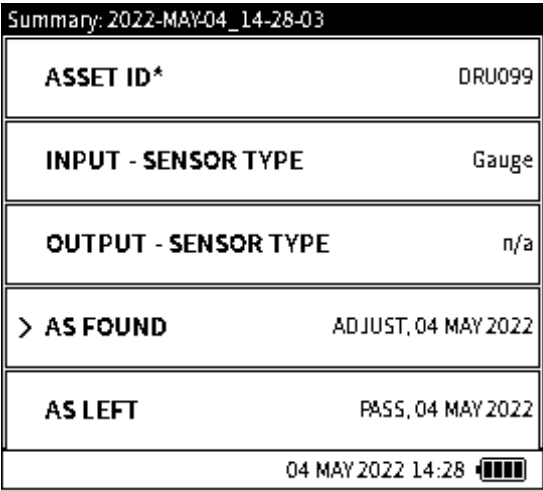
11.6 Post Examination of Test Procedure Results

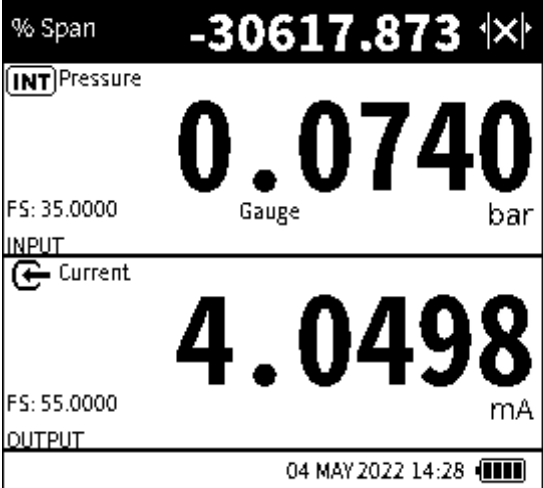

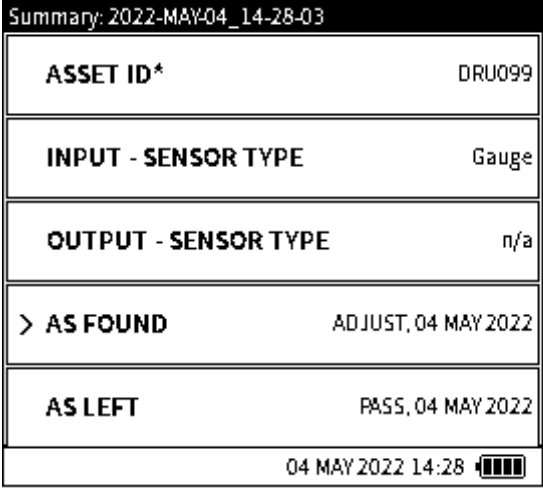

<p>Step 1</p>		<p>Note: When a test procedure is done on a new Asset for the first time, there will be no As-Found or As-Left results. When no As-Found or As-Left results are detected for a particular asset, the calibration data will be automatically saved as As-Found. If As-Found or As-Left results file is detected, then at the end of the test procedure there is the option to save the results as As-Found or As-Left. Selecting As-Found will overwrite any existing As-Found data. If no As-Left data is detected, and save as As-Left is selected, then a new As-Left results file is saved. If As-Left data file exists already, then the file is overwritten if As-Left option is selected.</p>
<p>Step 2</p>		<p>On the Test Procedure Summary screen, the option to re-run the test procedure using the same test details and device under test (DUT) details is provided by using the Play  softkey.</p> <p>If you wish to exit, use the Back softkey to return to the Internal Files Procedure menu.</p>

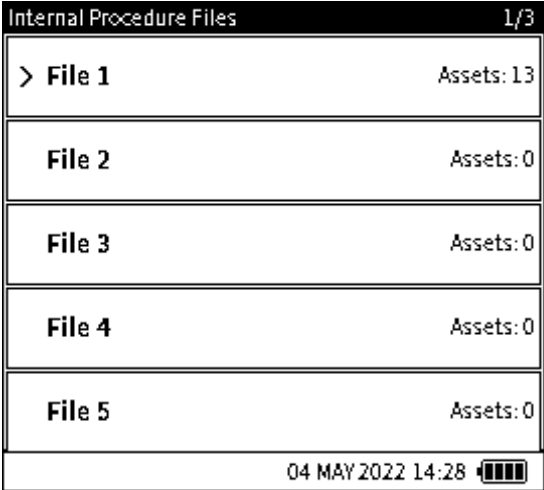
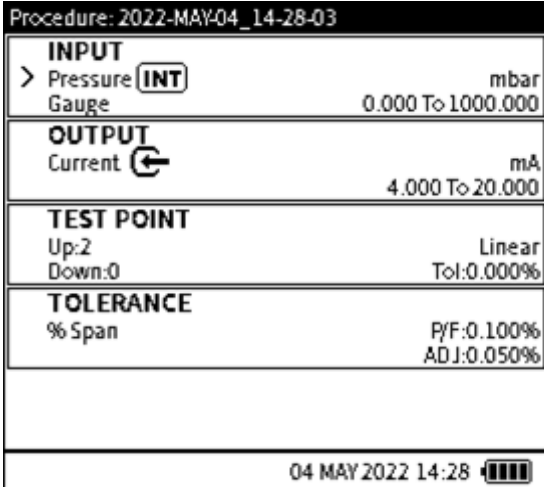

11.7 Making an adjustment on the Device Under Test (DUT)

<p>Step 1</p>		<p>If at the end of the test procedure, an adjustment is required. For example, if the end result of the test procedure is a Fail. Then it is possible to perform and verify an adjustment using the Analysis  softkey.</p>
<p>Step 2</p>		<p>Make the necessary adjustment to the DEVICE UNDER TEST (DUT) and check the output signal through its entire calibration range to ensure it is within spec before repeating the calibration test procedure. When the adjustment is complete, select the Back  softkey to return to the Procedure Summary screen.</p>
<p>Step 3</p>		<p>The test procedure may now be done again after adjustment. Select the Play  softkey or icon to do this.</p>

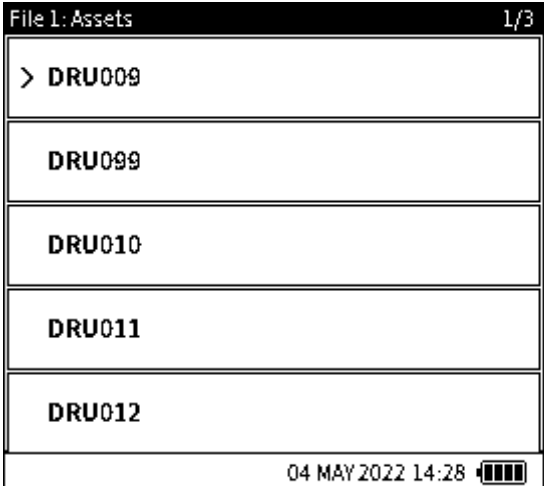

11.8 How to redo a Test Procedure

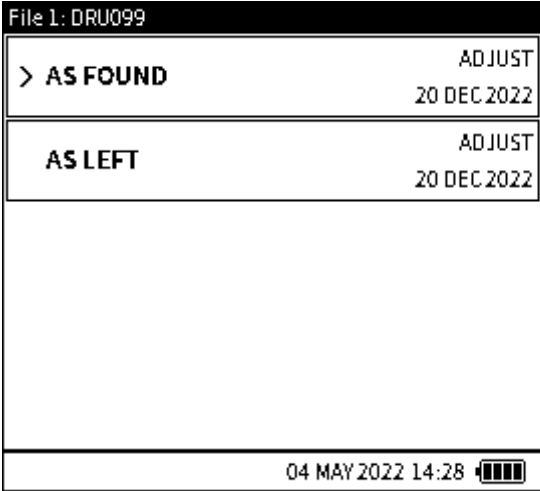
The instructions in this section relate to doing a Test Procedure again for an existing asset or Device Under Test (DUT).

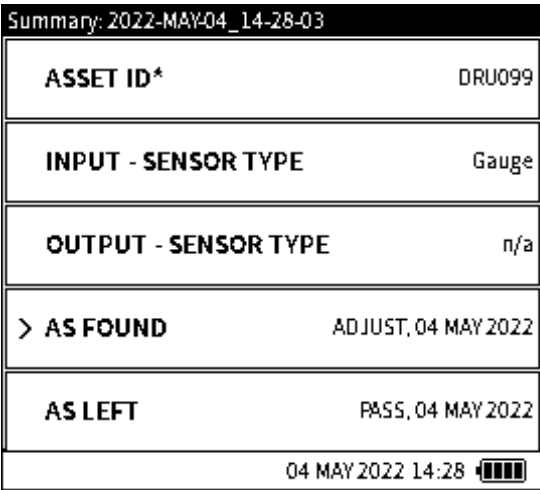

<p>Step 1</p>		<p>Select the desired test procedure file from the list in the Internal Procedures Files screen.</p>
<p>Step 2</p>		<p>Select the Briefcase (Assets)  softkey to view the asset details which the test procedure has been done on.</p>
<p>Step 3</p>		<p>On the Assets screen, view all assets that this specific test procedure has been done on and logged. Note: Up to 25 Assets and results can be saved for each calibration test procedure. To redo the test procedure on the selected asset or Device Under Test (DUT). Select the Play  softkey from this menu screen.</p>

Step 4	 <p>File 1: DRU099</p> <table border="1"> <tr> <td>> AS FOUND</td> <td>ADJUST 20 DEC 2022</td> </tr> <tr> <td>AS LEFT</td> <td>ADJUST 20 DEC 2022</td> </tr> </table> <p>04 MAY 2022 14:28 </p>	> AS FOUND	ADJUST 20 DEC 2022	AS LEFT	ADJUST 20 DEC 2022		<p>To view As-Found or/and As-Left calibration results, select the desired Asset filename by tapping once to select and a second time to open. Any available results associated with that test procedure and asset will appear on the screen.</p>
	> AS FOUND	ADJUST 20 DEC 2022					
AS LEFT	ADJUST 20 DEC 2022						

11.9 How to View Test Results.

Step 1	 <p>Summary: 2022-MAY-04_14-28-03</p> <table border="1"> <tr> <td>ASSET ID*</td> <td>DRU099</td> </tr> <tr> <td>INPUT - SENSOR TYPE</td> <td>Gauge</td> </tr> <tr> <td>OUTPUT - SENSOR TYPE</td> <td>n/a</td> </tr> <tr> <td>> AS FOUND</td> <td>ADJUST, 04 MAY 2022</td> </tr> <tr> <td>AS LEFT</td> <td>PASS, 04 MAY 2022</td> </tr> </table> <p>04 MAY 2022 14:28 </p>	ASSET ID*	DRU099	INPUT - SENSOR TYPE	Gauge	OUTPUT - SENSOR TYPE	n/a	> AS FOUND	ADJUST, 04 MAY 2022	AS LEFT	PASS, 04 MAY 2022		<p>Results can be viewed immediately after the test procedure is complete, by tapping on the required result (i.e., As-Found or As-Left) from the procedure SUMMARY screen.</p>
	ASSET ID*	DRU099											
INPUT - SENSOR TYPE	Gauge												
OUTPUT - SENSOR TYPE	n/a												
> AS FOUND	ADJUST, 04 MAY 2022												
AS LEFT	PASS, 04 MAY 2022												

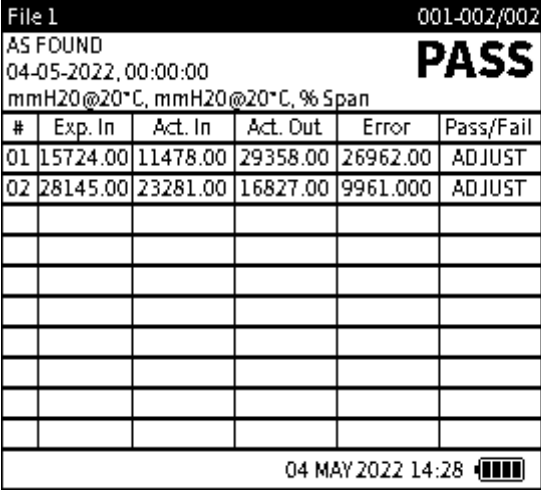
Chapter 11. Documenting

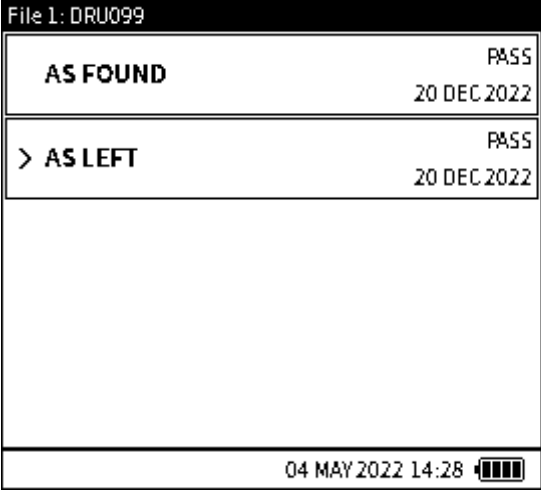
<p>Step 2</p>	 	<p>The calibration test procedure results show the following:</p> <ul style="list-style-type: none"> • Result type – As-Found or As-Left • Date/Time – the date and time stamp the calibration procedure was completed • Details of the input and output function i.e. Function name and measurement units • Data details including: <ul style="list-style-type: none"> • Input Expected • Input (Actual) • Output • Calculated Error • Pass or Fail status for each test point • Pass or Fail Status overall. <p>To view Calibration remarks relating to the test, select the Clipboard  softkey.</p>
<p>Step 3</p>		<p>Results can also be viewed when the test procedure is selected, the device under test is selected and then the relevant test result i.e. As-Found or As-Left.</p>

11.10 Deleting Asset Data

Step 1		<p>Select the required test procedure. Select the required asset to be deleted.</p> <p>Select the Delete softkey.</p> <p>Note: All asset data will be deleted.</p>
	<p>04 MAY 2022 14:28 </p>	<p></p> <p></p> <p></p> <p></p>

11.11 How to use the Calibration Certificate Wizard

Step 1	<table border="1"> <thead> <tr> <th>#</th> <th>Exp. In</th> <th>Act. In</th> <th>Act. Out</th> <th>Error</th> <th>Pass/Fail</th> </tr> </thead> <tbody> <tr> <td>01</td> <td>15724.00</td> <td>11478.00</td> <td>29358.00</td> <td>26962.00</td> <td>ADJUST</td> </tr> <tr> <td>02</td> <td>28145.00</td> <td>23281.00</td> <td>16827.00</td> <td>9961.000</td> <td>ADJUST</td> </tr> </tbody> </table>	#	Exp. In	Act. In	Act. Out	Error	Pass/Fail	01	15724.00	11478.00	29358.00	26962.00	ADJUST	02	28145.00	23281.00	16827.00	9961.000	ADJUST	<p>When an As-Found or As-Left asset or Device Under Test (DUT) result is viewed, it is possible to create a certificate document, using the calibration and test procedure details.</p> <p>Select the QR code softkey to access the QR code for the calibration certificate template.</p> <p>This template transforms the raw calibration procedure result data to a formatted calibration certificate document.</p>
	#	Exp. In	Act. In	Act. Out	Error	Pass/Fail														
01	15724.00	11478.00	29358.00	26962.00	ADJUST															
02	28145.00	23281.00	16827.00	9961.000	ADJUST															
Step 2	<p>DPI610E CERTIFICATE TEMPLATE</p> <p>For information on how to create a calibration certificate, please use QR code or visit druck.com/DPI610E to download DPI610E-CERTIFICATE-TEMPLATE.xls</p>	<p>Download the certificate template either using the URL or QR code provided.</p>																		

Chapter 11. Documenting

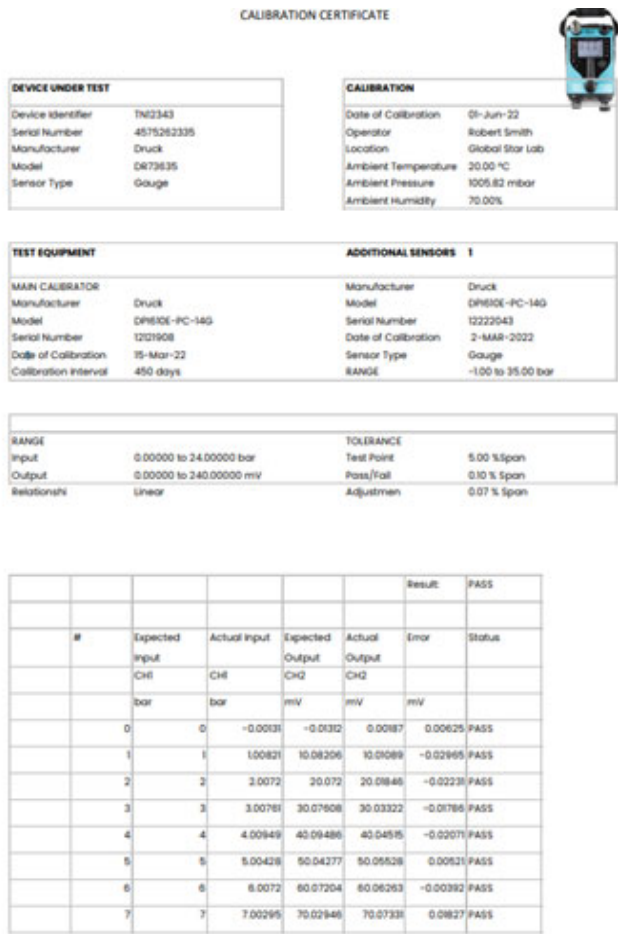
<p>Step 3</p>		<p>Connect the DPI 610E to a PC using a compatible data micro-USB cable. Note: Make sure the USB setting is in Storage mode (See Section 4.3 on page 45). Open the Calibration Certificate Template file and click on the Select CSV cell. Select the required asset result file from the DocData folder in the DPI 610E mass storage drive in File Explorer and select Open. The calibration data and test procedure data will be populated in the template format. To add a logo, select the Add Logo cell, and select the desired logo image and select OK to use.</p>
<p>Step 4</p>		<p>When the calibration certificate document has been formatted and edited to suit the user requirements, it can then be exported as a PDF file using the Export button on the template CSV and selecting a destination file path for it to be saved.</p>

12. HART

12.1 HART® Connection

The DPI 610E supports the HART® (Highway Addressable Remote Transducer) communication protocol and allows basic HART operation and configuration on HART supported devices. The HART bi-directional communications technology works as a master/slave protocol and when connecting the DPI 610E to the HART device, the DPI 610E acts as the master and the HART device, the slave. The DPI 610E supports commonly used functions from the Universal and Common Practice commands specified in HART revision 5, 6 and 7.

The HART function is only available on **CH2**. The function uses the current loop signal for its communication: the DPI 610E can provide 10 V/24 V loop power supply to the HART Device if required. The DPI 610E also offers an optional 250-ohm resistor that provides the voltage drop required for the HART communication when an external HART resistor is not available.

The DPI 610E can be used to communicate with HART devices as a:





Primary Master - the DPI 610E starts and controls all communications. The field device (slave) uses each command from the master device to make a change and/or send data back.

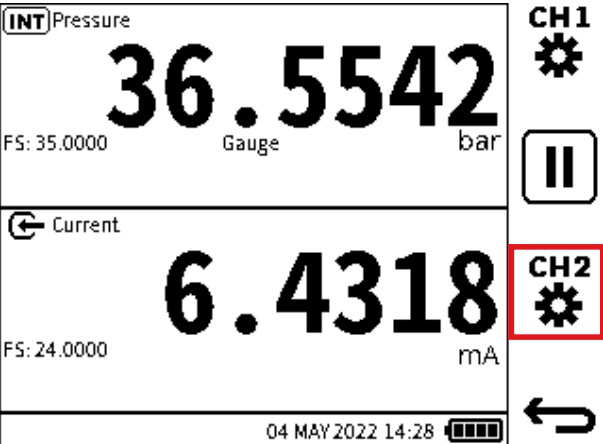
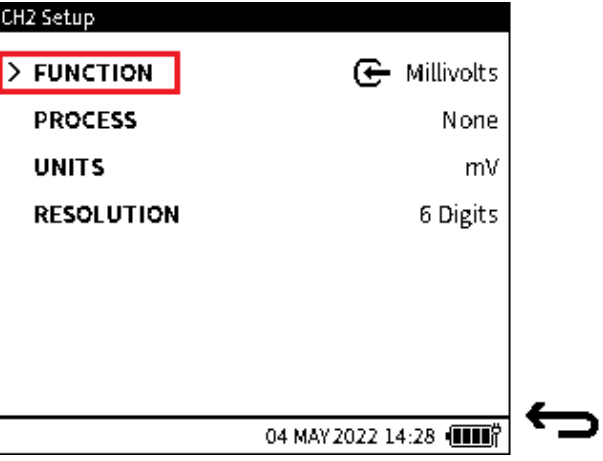

Secondary Master - the DPI 610E connects to an existing HART communications network. The Secondary Master communicates with the field device between Primary Master messages.

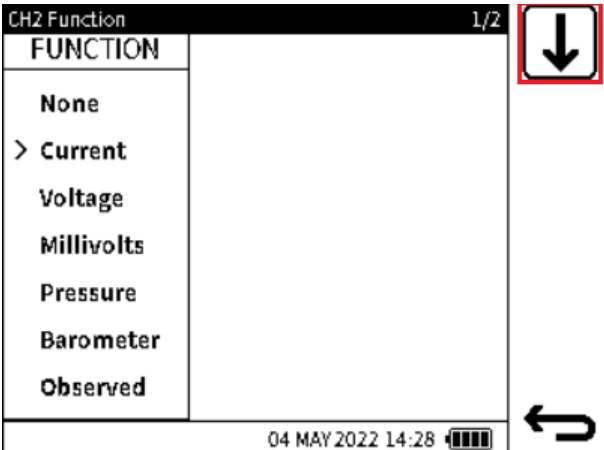
12.1.1 Starting the HART application (1st Method)

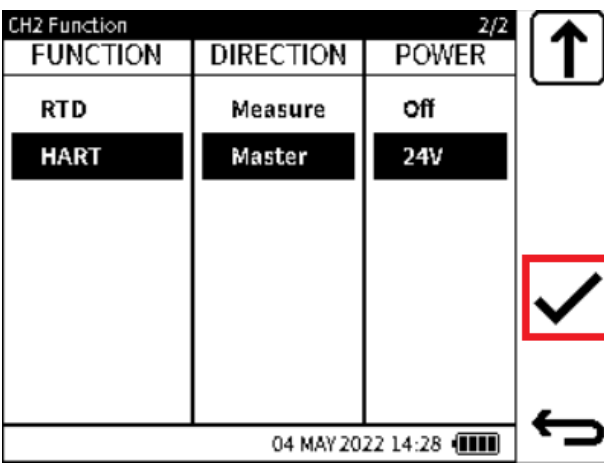

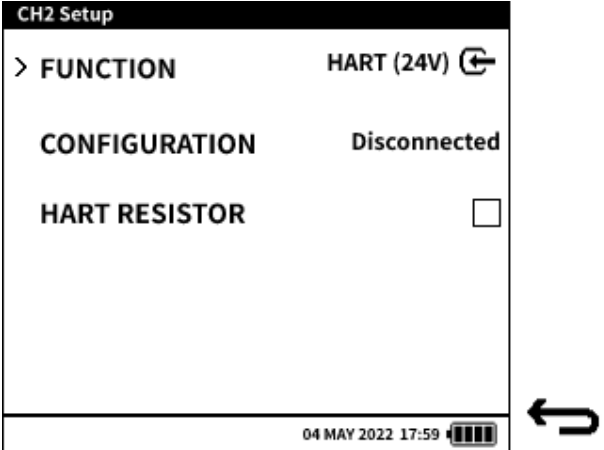
<p>Step 1</p>		<p>From the Calibrator screen: select the channel 2 Setup (either tap the screen icon or press the softkey.) Note: The HART function is only available on CH2.</p>
<p>Step 2</p>		<p>Select FUNCTION from the CH2 Setup screen.</p>

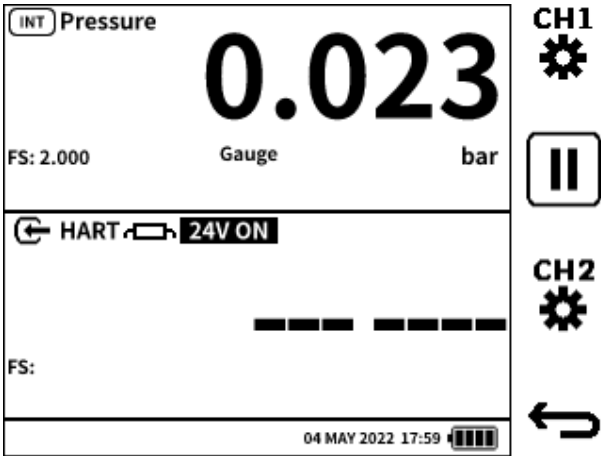
Chapter 12. HART

<p>Step 3</p>		<p>Select the Page Down  softkey to view the second page of CH2 functions.</p>
<p>Step 4</p>		<p>Select HART in the FUNCTION column. Choose the desired DIRECTION (Measure or Master). Select the loop power option (Off to use an external power supply or 24 V to use the DPI 610E internal power supply).</p> <p>Select the Tick  icon to confirm the selection and configure the instrument.</p>
<p>Step 5</p>		<p>In the CH2 Setup screen, the HART function is displayed. The configuration status is also shown (i.e. HART device connected or disconnected). See Section 12.2 on page 209 for Configuration details. The 250-ohm HART resistor option allows the DPI 610E provide the resistor when enabled (checkbox ticked). If the instrument is connected directly to a network, there must be a 250-ohm resistor connected in series with the loop power supply and the HART device. Here the HART resistor should be disabled in the setup (checkbox unticked).</p>

<p>Step 6</p>		<p>Note: the 250-ohm HART resistor is important in allowing communication with the HART device, as it provides enough impedance in the signal loop for the HART signal to develop.</p> <p>Select the Back  softkey to return to the Calibrator screen.</p> <p>HART is configured in CH2.</p>
---------------	---	---

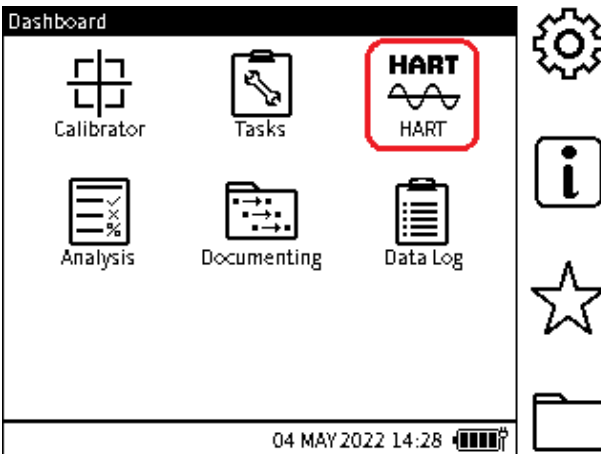
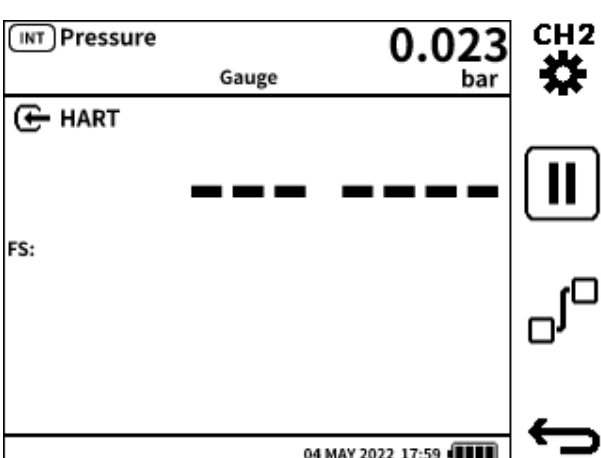
12.1.2 Starting the HART application (2nd Method)

<p>Step 1</p>		<p>From the Dashboard select the HART icon (either tap the screen icon or press the softkey.)</p>
<p>Step 2</p>		<p>Tap in the HART bottom screen area to enlarge the window and show the CH2 icon. Select this icon to show the CH2 Setup screen.</p> <p>You can follow the procedure in Section 12.1.1 on page 205 from step 2 forward to configure the HART function.</p> <p>To establish communication between the instrument and the HART device, select the Configuration  softkey.</p>







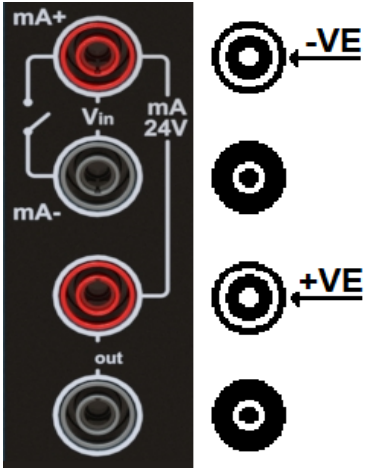
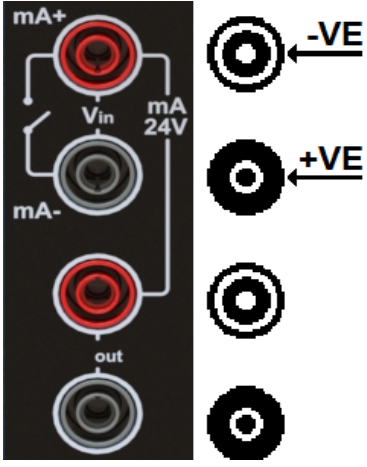

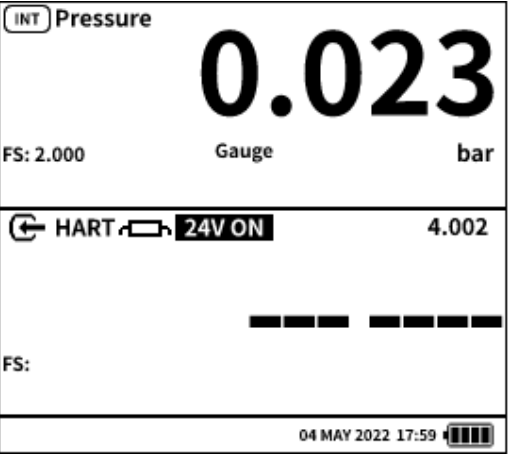

Chapter 12. HART

12.1.3 HART device electrical connection

Use the electrical connection locations as shown below.

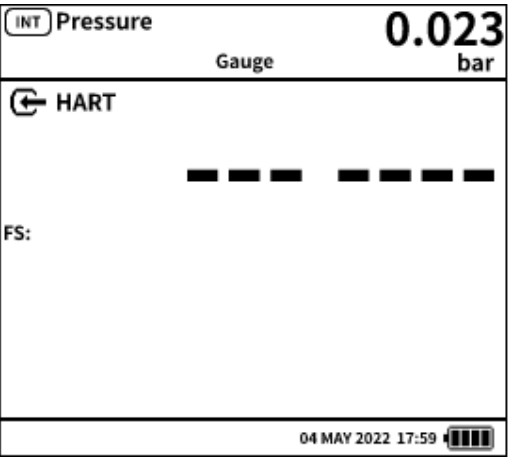
 <p>The diagram shows a vertical terminal block with five terminals. From top to bottom: a red terminal labeled 'mA+', a terminal labeled 'Vin' with a switch, a terminal labeled 'mA-', a red terminal labeled 'out', and a terminal labeled 'out'. To the right of the terminal block are four circular terminals. The top terminal is labeled '-VE' with an arrow pointing to it. The second terminal is empty. The third terminal is labeled '+VE' with an arrow pointing to it. The fourth terminal is empty.</p>	<p>HART with internal 24 V loop power enabled</p>
 <p>The diagram shows a vertical terminal block with five terminals. From top to bottom: a red terminal labeled 'mA+', a terminal labeled 'Vin' with a switch, a terminal labeled 'mA-', a red terminal labeled 'out', and a terminal labeled 'out'. To the right of the terminal block are four circular terminals. The top terminal is labeled '-VE' with an arrow pointing to it. The second terminal is labeled '+VE' with an arrow pointing to it. The third terminal is empty. The fourth terminal is empty.</p>	<p>HART with external loop power (internal loop power disabled).</p>

12.2 HART Device Configuration

<p>Step 1</p>		<p>CH1</p>    	<p>When the HART device has been physically connected to the DPI 610E (electrical connection and/or pressure connection), the loop current measured by the DPI 610E is displayed as the secondary reading in the CH2 window. To establish communication between the instrument and the HART device, select the Configuration  softkey. Note: When the HART device has no communication with the DPI 610E, an animated set of dashed lines (-----) appears in the primary reading area.</p>
<p>Step 2</p>		<p>CH2</p>    	<p>Alternatively, the Configuration menu can be accessed from the CH2 Setup screen. Note: if the HART application is already running, maximize the CH2 window to access the CH2 Setup softkey.</p>
<p>Procedure continues with Step 3 on next page</p>			

Step 3

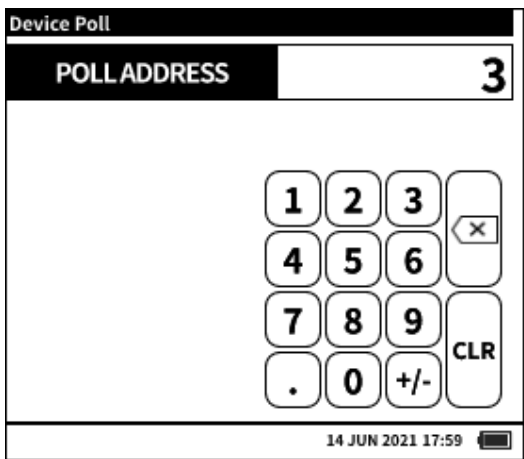
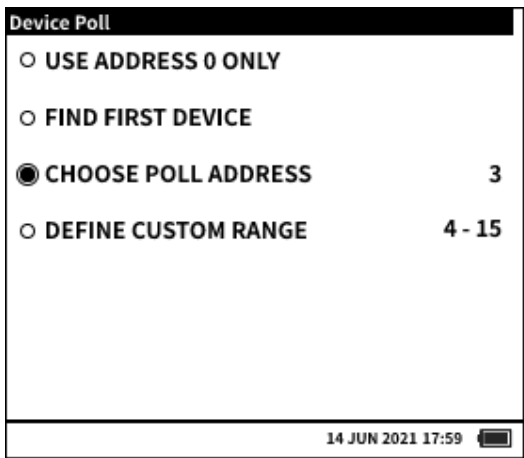
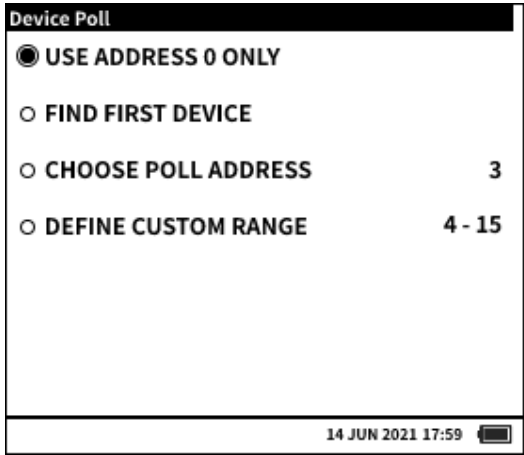



The connected **HART** device can be configured with its unique Poll Address. The configuration screen provides options for the **HART** device polling. Select one of the following Device Poll methods to use:

The connected HART device can be configured with its unique Poll Address. The configuration screen provides options for the HART device polling. Select one of the following Device Poll methods to use:

1. **USE ADDRESS 0 ONLY** - Searches for any connected devices with Poll Address 0 only.
2. **FIND FIRST DEVICE** – Searches the full Poll Address range (0 to 63) and identifies the first device found.
3. **CHOOSE POLL ADDRESS** – Searches a single user specified Poll Address.
4. **DEFINE CUSTOM RANGE** – Searches a user specified Poll Address range.

When the **CHOOSE POLL ADDRESS** is selected, the Poll Address number to search must be entered. The default is 0.

To edit the Address value, select the **Edit**  softkey and enter the desired value. Press the **Tick**  softkey to accept and the **Back**  softkey to return to the **Device Poll** screen.



Note: Valid Poll Address value must be between 0 and 63).

Step 3 procedure continues on next page

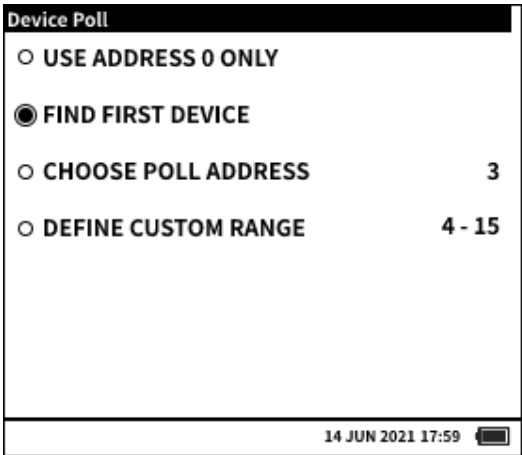
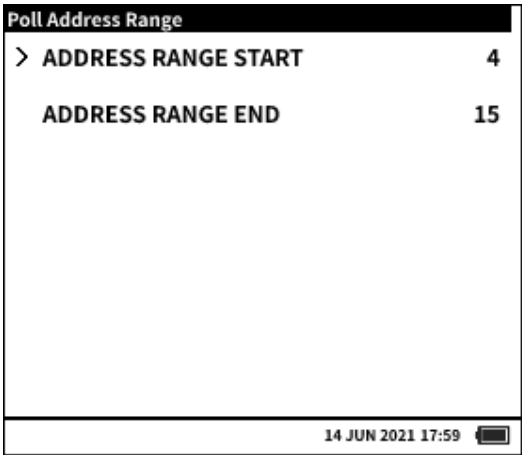
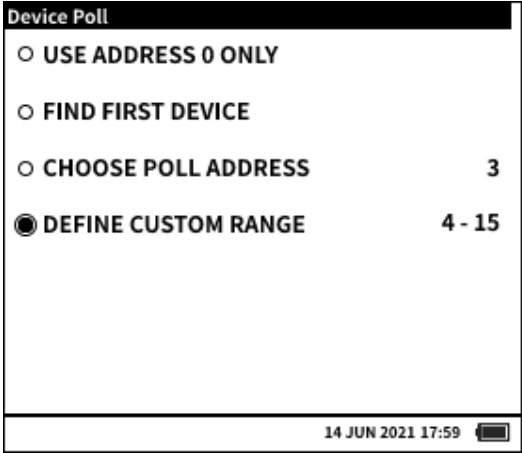
Step 3
Cont'd







When the **DEFINE CUSTOM RANGE** option is selected, the Poll Address range must be specified. The default is 0 to 63.

To edit the Address range, select the **Edit**  softkey and enter the desired **START** and **END** value. Press the **Tick**  softkey to accept and the **Back**  softkey to return to the **Device Poll** menu. **Note:** Valid Poll Address range must be between 0 and 63.

Once the desired Poll method has been set up, select the **Search**  softkey to begin.

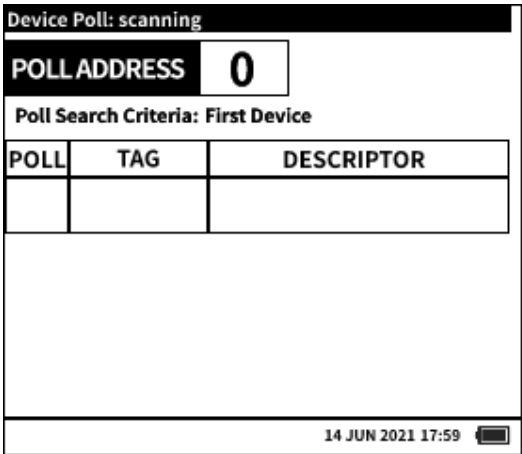
Step 3 procedure continues on next page

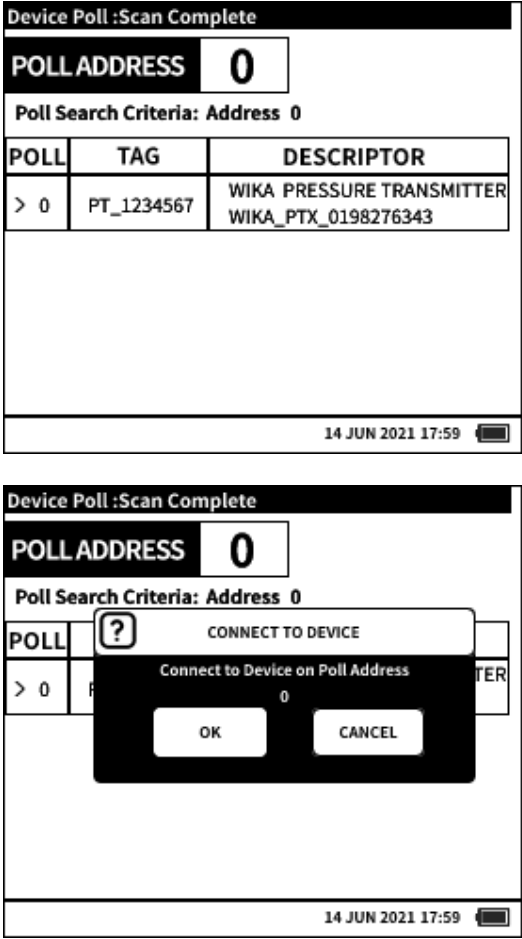
Chapter 12. HART

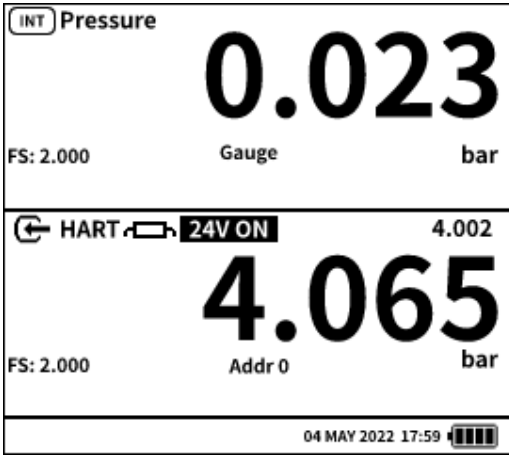

<p>Step 3 Cont'd</p>		<p>In the Device Poll screen the following information is available:</p> <ol style="list-style-type: none"> 1. In the Title bar, the Device Poll status is provided i.e., Scanning or Scan Complete. 2. Poll Address being currently searched. 3. Poll Search method or criteria. 4. Search result table which displays the Poll Address, Tag and Descriptor of the device when successfully found. It can display up to four found devices. <p>The scan can be aborted at any time if necessary, by using the Stop  softkey. Restart the scan by selecting the Search  softkey.</p>
<p>Step 4</p>		<p>When the scan is complete or when the scan is aborted, any detected HART device(s) will be displayed in the table. If more than one device is displayed, select the desired device to connect to, by tapping the device details or using the navigation keypad.</p> <p>Select the Tick  softkey to connect to the selected device.</p> <p>Select OK to connect to the selected device and return to the Calibrator screen or CANCEL to return to the Device Poll configuration screen.</p>
<p>Step 4 continues on next page</p>		

Step 4
Cont'd

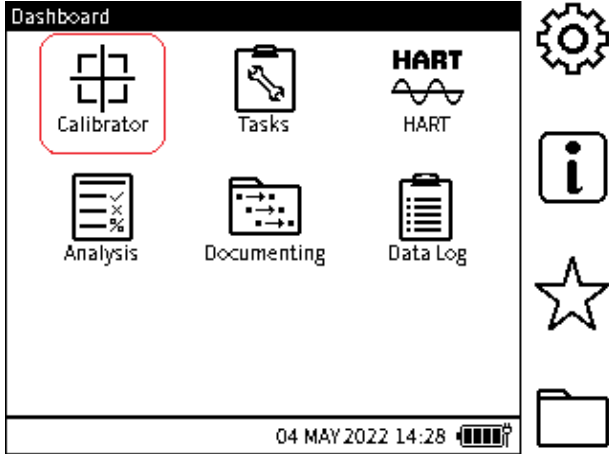
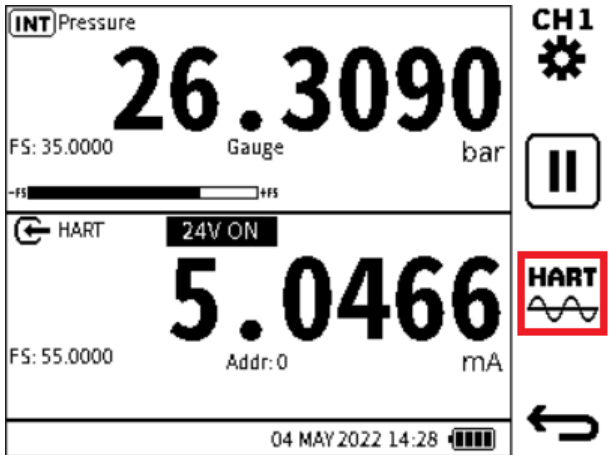

The **HART** device is now connected, and the Primary reading displays the Primary Variable reading from the **HART** device. The device Poll Address is displayed as well as its full-scale value.

12.3 HART Dashboard

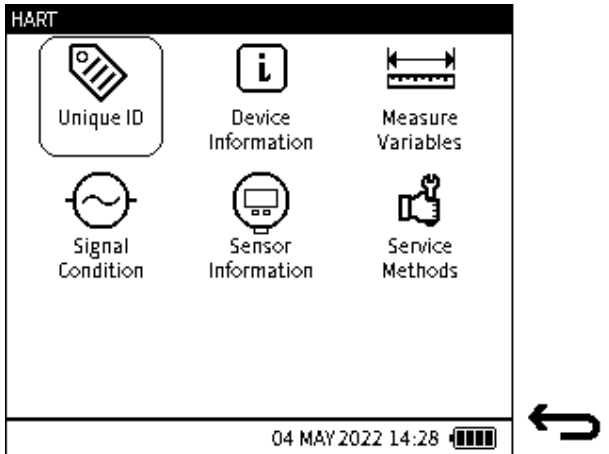
<p>Step 1</p>		<p>From the Dashboard: select the Calibrator icon. The Calibration screen will appear: the CH2 is replaced by the HART icon. Note: for the HART softkey to appear in the next screen, the HART device must be connected successfully to the DPI 610E. See previous section.</p>
<p>Step 2</p>		<p>From the Calibrator screen: select the HART channel  icon (either tap the screen icon or press the softkey.)</p>
<p>Step 3</p>		<p>A screen of HART options appears. These options are described in the rest of this chapter.</p>

12.3.1 Unique ID

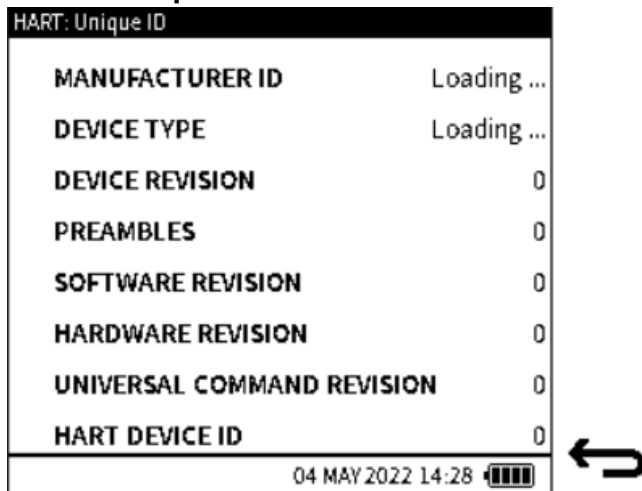

Figure 12-1: Unique ID screen

The **Unique ID** screen gives identity information about the connected **HART** device. This **HART** command gets the long address of the device plus other manufacturer information available.

The **PREAMBLES** data relates to the code that identifies the start and end of a data packet.

Note: this is a read-only screen.

12.3.2 Device Information



Figure 12-2: Device Information screen

The **HART: Device Information** screen displays editable information about the device. The information options available are shown in the Figure 12-2 above. To edit any of the device

information, select the option and enter the desired value or text. Select the **Tick** ✓ softkey to confirm and write this new change to the device.

The **PREAMBLES** data relates to the code that identifies the start and end of a data packet.

Note: The Device Information screen options are all user editable as indicated by the mini-pencil

✎ icon at the end of each option line.

12.3.3 Measure Variables

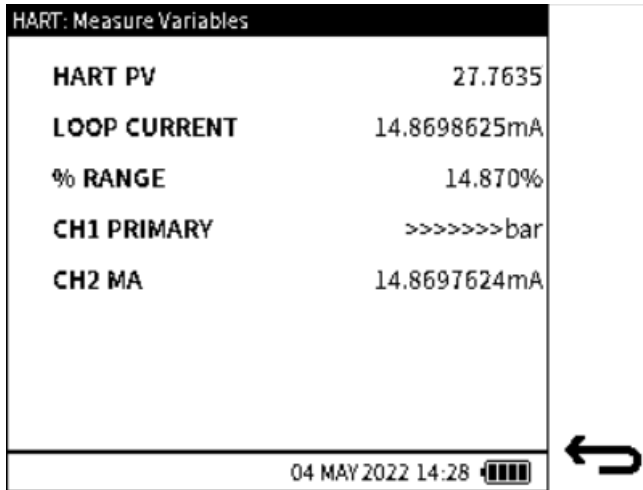

Figure 12-3: Measure Variables screen

This screen shows the following variables:

- HART PV (Primary variable)
- Loop Current (Measured by HART device)
- % Range (Percentage - the current PV reading of the PV range)
- CH1 Primary (Primary reading on CH1)
- CH2 MA (Loop current measured by the DPI 610E).

12.3.4 Signal Condition

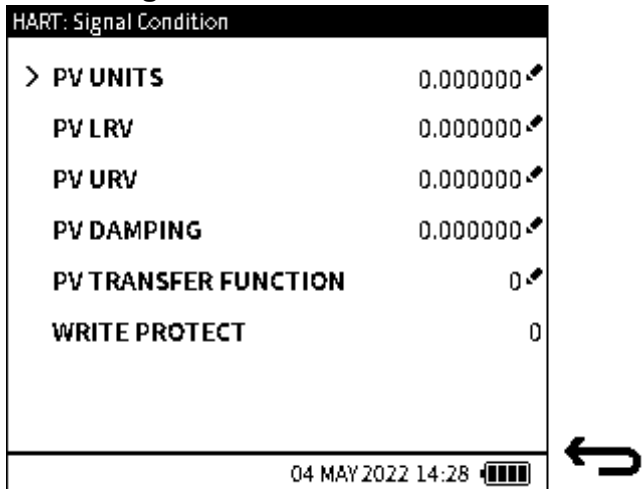
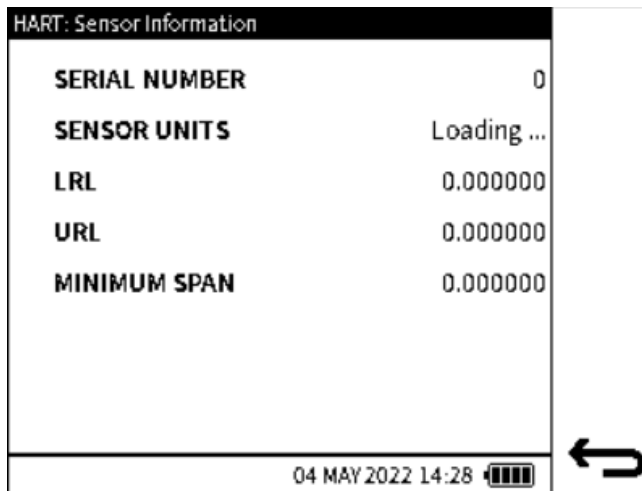

Figure 12-4: Signal Condition screen

This screen shows the following variables (variables with a pen icon can be edited):

- PV Units (Measurement units the primary variable is displayed)
- PV LRV (Primary variable Lower Range Value)
- PV URV (Primary variable Upper Range Value)
- PV Damping (Primary variable damping value in seconds)
- PV Transfer Function (Primary function transfer function selection code)
- Write Protect (Write protect code).

12.3.5 Sensor Information



HART: Sensor Information	
SERIAL NUMBER	0
SENSOR UNITS	Loading ...
LRL	0.000000
URL	0.000000
MINIMUM SPAN	0.000000

04 MAY 2022 14:28 

Figure 12-5: Sensor Information screen

This screen shows the following variables:

- Serial Number
- Sensor Units
- LRL (Lower Range Limit)
- URL (Upper Range Limit)
- Minimum Span.

Note: This is a read-only screen.

12.4 HART Service Methods

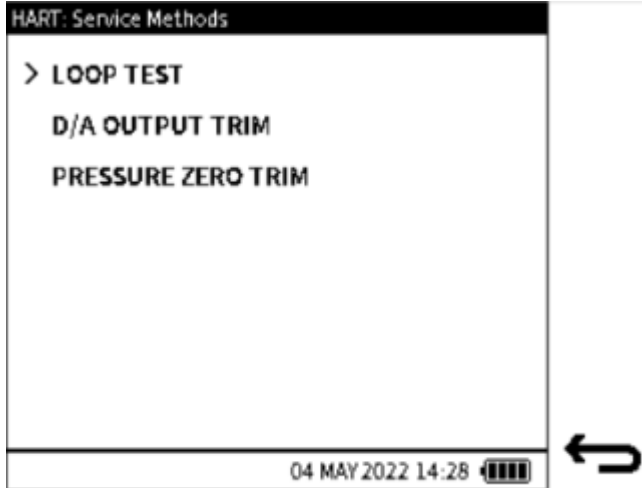

Figure 12-6: Service Methods screen

The Service Methods available on the DPI 610E are:



1. **LOOP TEST**
2. **D/A OUTPUT TRIM** (page 220)
3. **PRESSURE ZERO TRIM** (page 224).

12.4.1 LOOP TEST

The method is used to set the output of the **HART** device at a user specified analog (current) value. It is useful in testing the integrity of the current loop and ensures the system is functioning correctly. With the DPI 610E Loop test method, the user can force an output current between 4 and 20 mA for normal transmitter operation or <3.6 mA and >21 mA to verify failure alarm indication in the device.

To output a current:

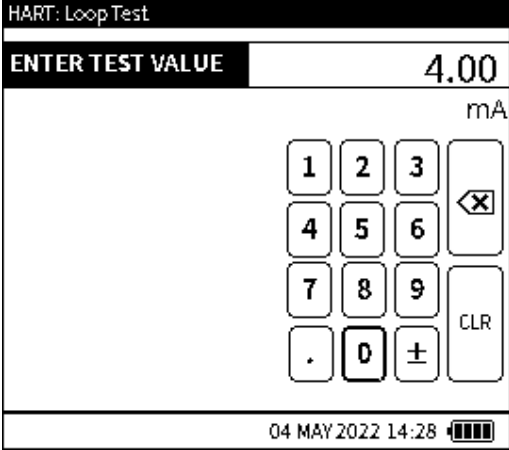
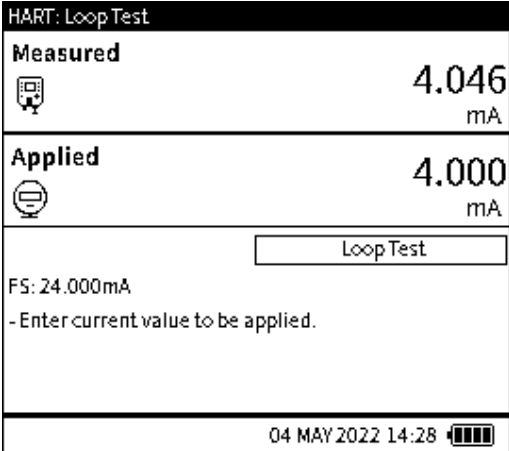
Step 1		<p>Select Loop Test from the Service Methods screen.</p> <p>In the Loop Test screen, select the Edit softkey.</p>
--------	--	--

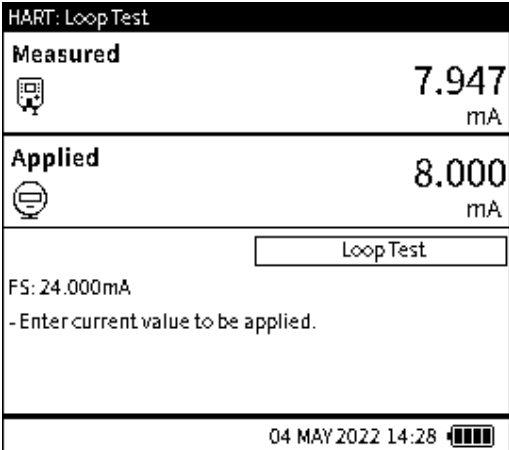







<p>Step 2</p>		<p>Enter the required output value and select the Tick ✓ softkey.</p>
<p>Step 3</p>		<p>On this screen, the current measured by the DPI 610E will be displayed as the result of the forced current output from the HART device. Note: The signal measured by the DPI610E is indicated by the , while that measured by the HART device is indicated by the  icon.</p>
<p>Step 4</p>		<p>Repeat as required with all the desired current output values and check the measured current value. To exit the loop test, select the Back ↶ softkey.</p>

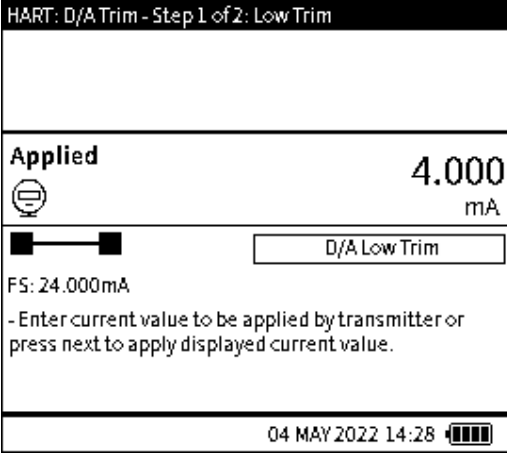

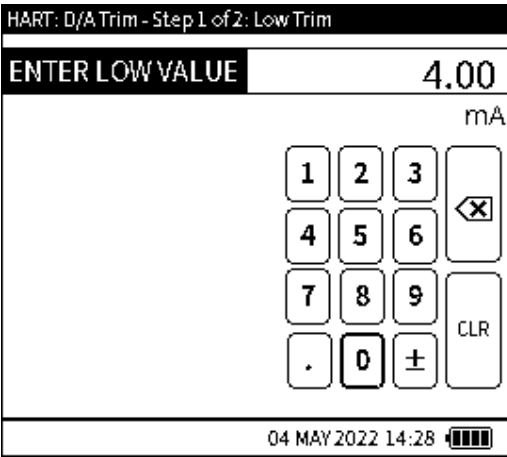

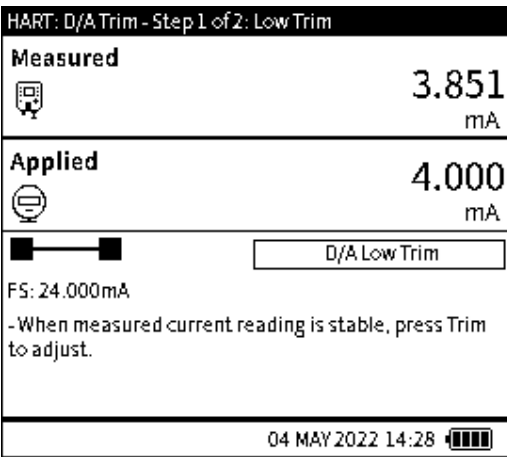
Chapter 12. HART

12.4.2 D/A OUTPUT TRIM



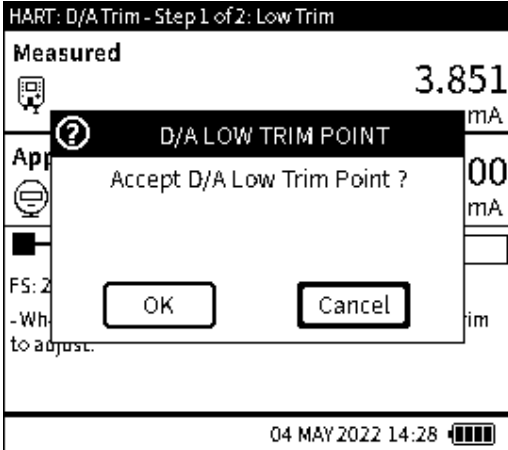
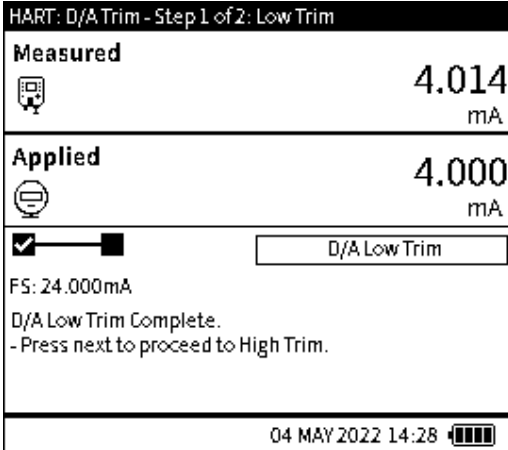

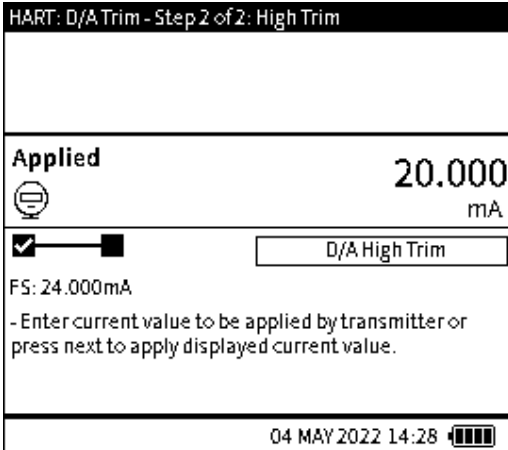
The D/A Output trim involves setting the HART device at the analog signal output of 4 and 20 mA to test that it matches an external standard. If required, a trim is performed at the low value point and/or the high value point which adjusts the transmitters digital to analog converter.

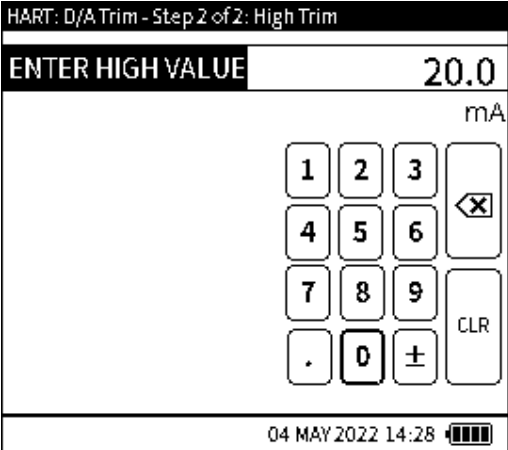
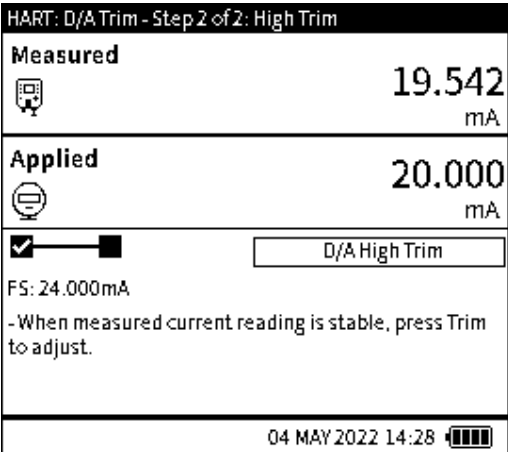

To perform a D/A Trim:

<p>Step 1</p>		<p>Select D/A OUTPUT TRIM from the HART: Service Methods screen (See Figure 12-6 on page 218.) The screen on the left is the first part of the D/A trim procedure which focuses on the Low (value) trim. The default Low Trim value is 4 mA. This value can be edited if required by selecting the Edit  softkey (Step 2). If no change is required, select the Next  softkey to proceed (Step 3).</p>
<p>Step 2</p>		<p>Enter the required Low Trim value and select the Tick  softkey to confirm this value.</p>
<p>Step 3</p>		<p>The Low Trim value has been applied and the measured value now appears. Note: The signal measured by the DPI 610E is indicated by the icon , while that measured by the HART device is indicated by . Make sure that the reading is stable. To perform the trim at this point, select the Trim  softkey.</p>
<p>Step 3 continues on next page</p>		

<p>Step 3 Cont'd</p>		<p>Select OK in the popup message window to accept the Trim. Or select CANCEL to return to the previous step.</p>
<p>Step 4</p>		<p>When the Low trim is complete, select the Next  softkey to proceed to the High Trim procedure or select the Back  softkey to exit.</p>
<p>Step 5</p>		<p>The second part of the D/A trim procedure focuses on the High (value) trim. The default High Trim value is 20 mA. This value can be edited if required by selecting the Edit  softkey (Step 6). If no change is required, select the Next  softkey to proceed (Step 7).</p>
<p>Procedure continues on next page</p>		

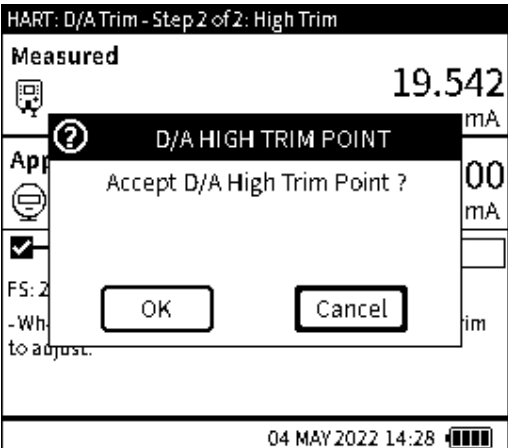
Chapter 12. HART

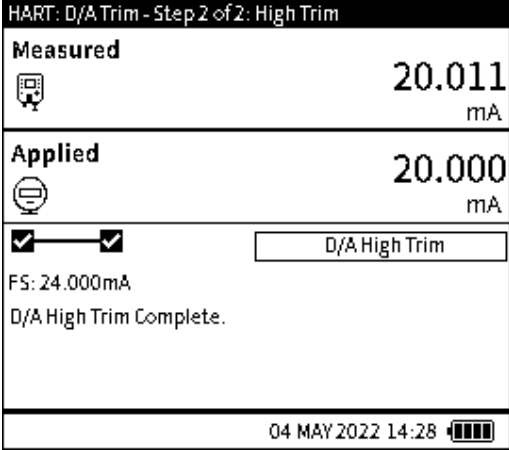
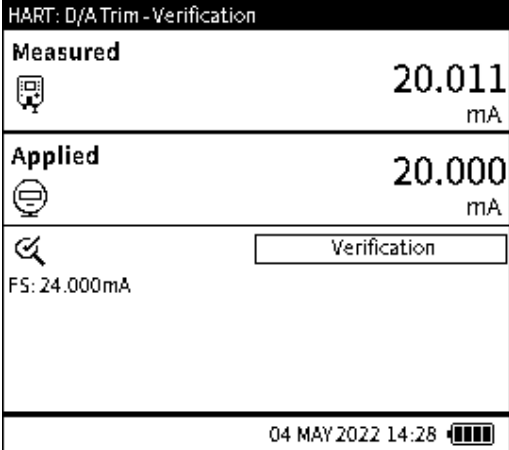
<p>Step 6</p>		<p>Enter the required High Trim value and select the Tick ✓ softkey to confirm.</p>
<p>Step 7</p>		<p>The High Trim value has been applied and the measured value is now displayed. Note: the signal measured by the DPI 610E is denoted by the icon , while that measured by the HART device is denoted by . Make sure that the reading is stable. To perform the trim at this point, select the Trim  softkey.</p>
<p>Step 8</p>		<p>Select OK in the popup message window to accept the Trim. Or select CANCEL to return to the previous step. The High Trim is complete which finishes this stage of the D/A trim procedure. The final step of the procedure is to verify that the D/A trim adjustment is sufficient.</p>
<p>Procedure continues on next page</p>		







<p>Step 9</p>		<p>Select the Verification softkey to test if the adjustment has been sufficient.</p>
<p>Step 10</p>		<p>In the Verification screen, use the Edit  softkey to enter test current output values between 0 and 24 mA and check the measured values at each point.</p> <p>To exit the Verification screen, use the Back  softkey.</p>

Chapter 12. HART

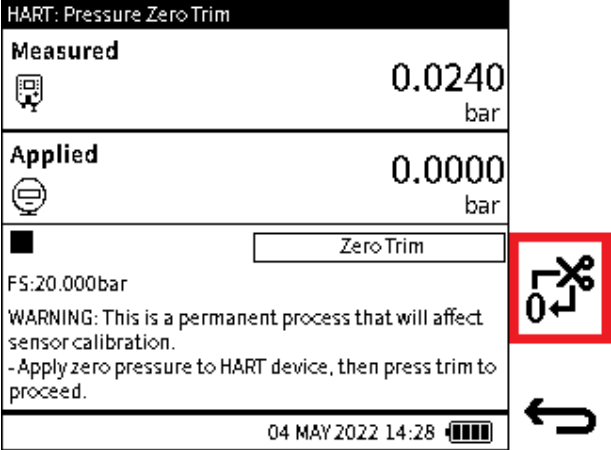
12.4.3 PRESSURE ZERO TRIM

A Zero Trim is a method used to cancel out zero-shift that could arise from sensor zero drift or change in installation orientation. It allows for the characterization data to be adjusted by correcting the zero (pressure) value when a “zero” input is applied.

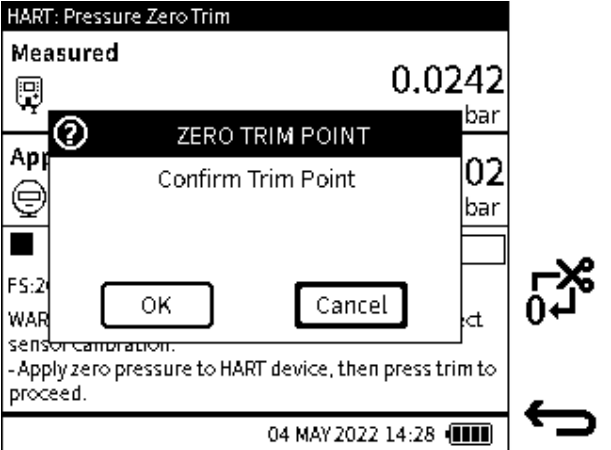
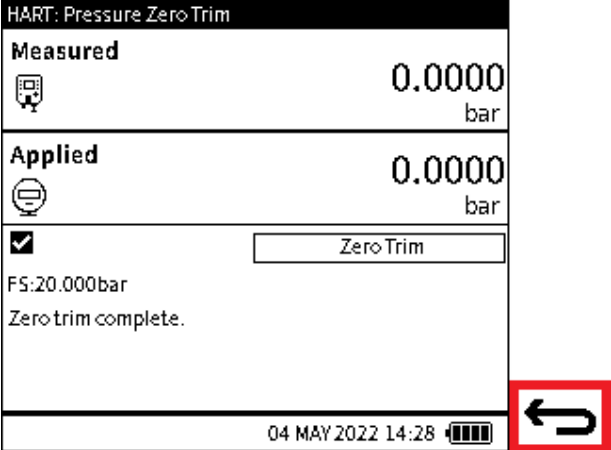
Note: Zero trim should only ever be applied to Gauge or Differential pressure sensors.

<p>Step 1</p>		<p>Select PRESSURE ZERO TRIM from the HART: Service Methods screen (See Figure 12-6 on page 218). Make sure the HART device has a secure process connection to the DPI 610E. Apply 0 pressure using the pump/volume adjuster on the instrument or vent the system. Wait and make sure the reading is stable. Note: the signal measured by the DPI 610E is denoted by the icon , while that measured by the HART device is denoted by . Select the Trim  softkey.</p>
<p>Step 2</p>		<p>Select OK in the popup message window to accept the Trim. Or select CANCEL to return to the previous step.</p>
<p>Step 3</p>		<p>When the Zero Trim is complete, use the Back  softkey to exit or repeat the Trim if required.</p>





12.5 HART Error and Message Codes

Error Code	Description
0	Success
1	Undefined Error
2	Invalid Selection
3	Passed Parameter Too Large
4	Passed Parameter Too Large
5	Too few data bytes received
6	Device-specific Command Error
7	In Write Protect Mode
8-14	Multiple Meaning Warning
16	Access Restricted
17	Invalid Device Variable Index
18	Invalid Unit Code
19	Device Variable Index Not Allowed
20	Invalid Extended Command Number
21	Invalid I/O Card Number
22	Invalid Channel Number
23	Sub-device Response Too Long
24-27	Reserved Warning
28	Multiple Meanings Error
32	Device is Busy
33	Delayed Response Initiated
34	Delayed Response Running
35	Delayed Response Dead
36	Delayed Response Conflict
37-59	Reserved Error
60	Payload too Long
61	No Buffer Available
62	No Alarm/Event Buffers Available
63	Priority too low
64	Command Not Implemented
65-72	Multiple Meanings Error
96-111	Reserved Warning

Table 12-1: HART Error Codes

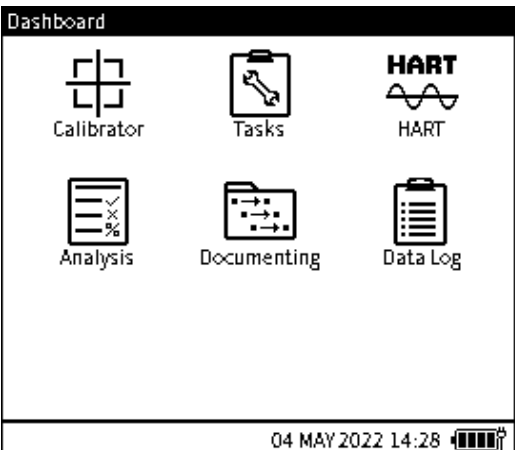
13. Instrument Calibration

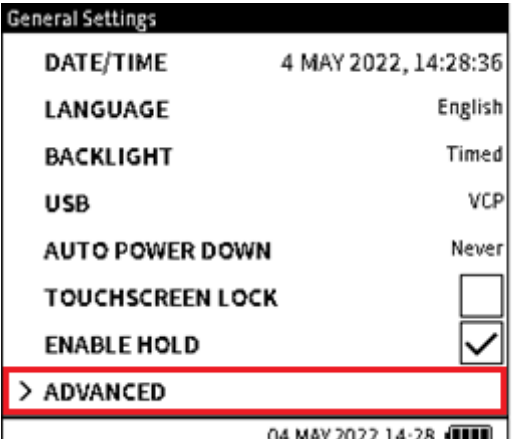
13.1 How to show the Instrument Calibration screen

<p>Step 1</p>		<p>Select the Settings icon  on the Dashboard. Tap on the icon or press the softkey on the right of icon.</p>
<p>Step 2</p>		<p>Select ADVANCED at the bottom of the General Settings screen. Tap on ADVANCED or use the Navigation Pad to move to bottom row and press the Pad's Enter  key to select.</p>

How to show the Instrument Calibration screen

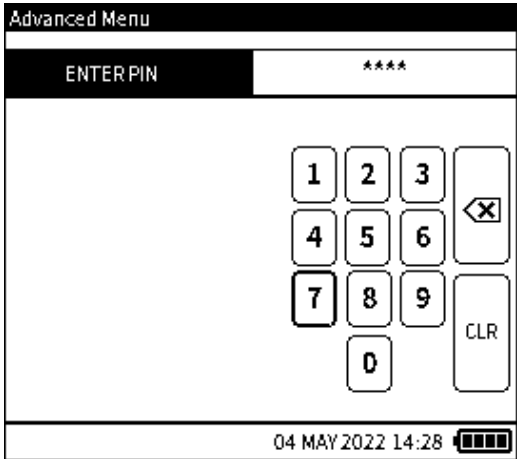
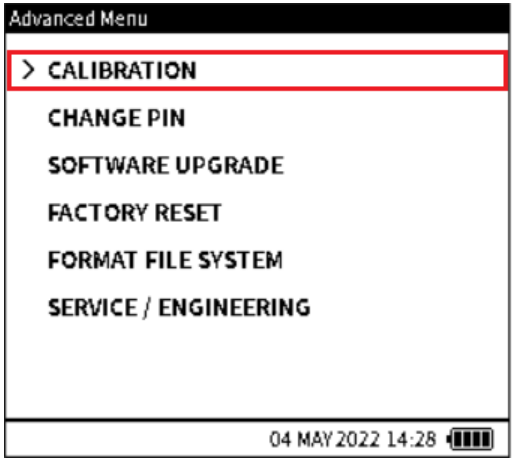
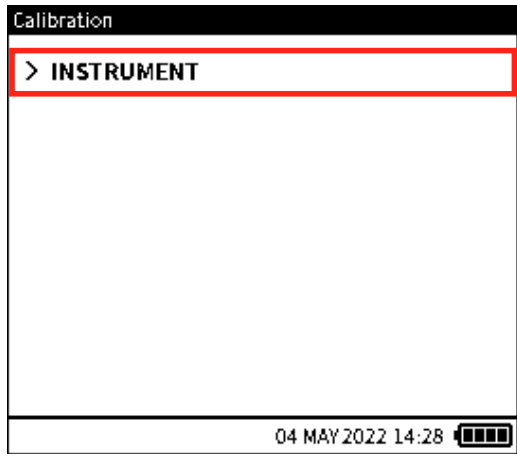
Step 3	 <p>Advanced Menu</p> <p>ENTER PIN *****</p> <p>1 2 3 4 5 6 7 8 9 0</p> <p>✓</p> <p>CLR</p> <p>04 MAY 2022 14:28</p>	<p>Use the onscreen keypad in the Advanced Menu screen to enter the PIN number 4321 and then select the tick ✓ icon.</p>
Step 4	 <p>Advanced Menu</p> <p>> CALIBRATION</p> <p>CHANGE PIN</p> <p>SOFTWARE UPGRADE</p> <p>FACTORY RESET</p> <p>FORMAT FILE SYSTEM</p> <p>SERVICE / ENGINEERING</p> <p>04 MAY 2022 14:28</p>	<p>In the Advanced Menu screen, select CALIBRATION. Refer to Chapter 5, “Advanced Menu” on page 52, for instructions on how to use the other Advanced Menu options.</p>
Step 5	 <p>Calibration</p> <p>> INSTRUMENT</p> <p>04 MAY 2022 14:28</p>	<p>Select INSTRUMENT in the Calibration screen to show the Instrument Calibration menu.</p>

Chapter 13. Instrument Calibration

Step 6		The different Instrument Calibration options are now available.
--------	---	--

13.1.1 The Instrument Calibration screen options

Option	Description
PERFORM CALIBRATION	Calibrate the instrument
INTERNAL PRESSURE SENSOR STATUS	View internal pressure sensor details
SET CALIBRATION DATE & INTERVAL	Set instrument date and interval
BACKUP CALIBRATION	Back up current calibration status
RESTORE CALIBRATION	Restore instrument to a previous calibration status
RESTORE FACTORY CALIBRATION	Return to the factory (default) calibration status

Note: The information in this chapter is for calibrating Internal and External sensors. The configuration of external sensors, to enable the DPI 610E to recognise and use external sensors, is explained in Chapter 8, “External Sensors” on page 141.

13.2 PERFORM CALIBRATION

The following functions are available in the **Perform Calibration** screen:

Function	Direction	Range
Current	Measure	20 mA 55 mA
	Source	24 mA
Voltage	Measure	20 V 30 V
	Source	10 V
Millivolts	Measure	200 mV 2000 mV
Pressure	Measure	Dependent on sensor fitted
Barometer	Measure	750 to 1150 mbar

Note: To access the **Perform Calibration** screen (Figure 13-1), select **PERFORM CALIBRATION** from the **Instrument Calibration** screen.

Note: The **Filter** process option must be **ON** for sensor calibration, see Section 6.3.3 on page 115 for the procedure.

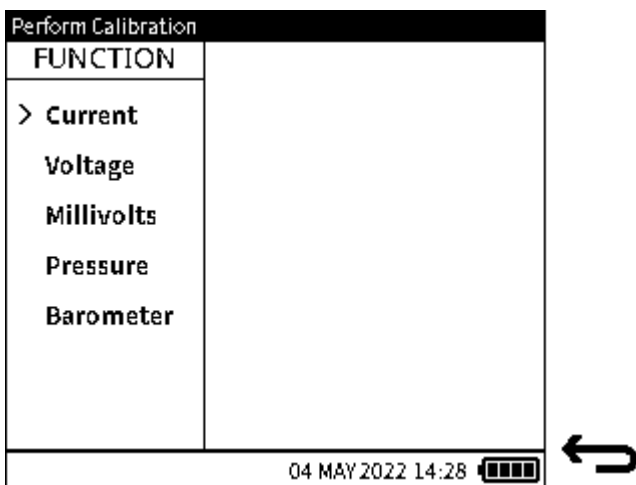

Figure 13-1: Perform Calibration screen

13.2.1 Calibration - Electrical Functions

The editing of **Current**, **Voltage** and **Millivolts** options is similar in procedure. Therefore, on the following pages the procedure used for editing Current variables is the same as for Voltage and Millivolts. The **Pressure** and **Barometer** options are described separately.

Chapter 13. Instrument Calibration



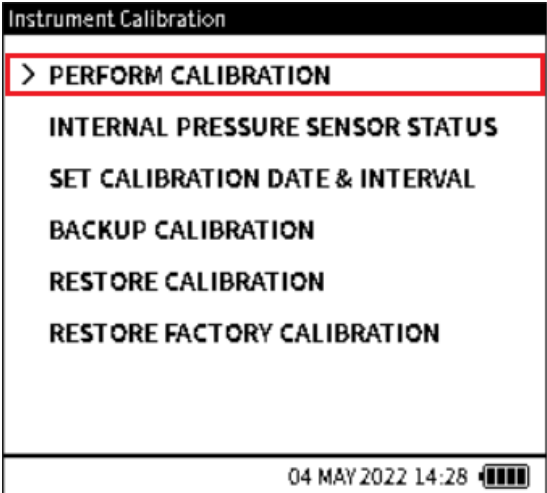
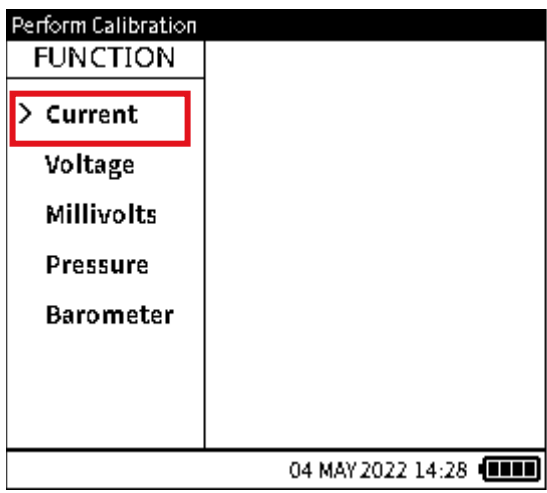
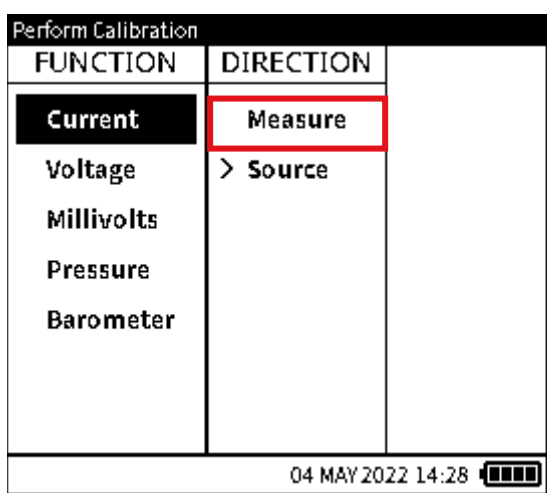

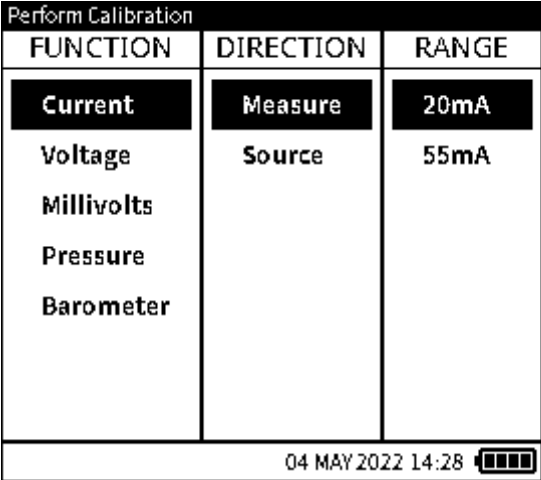
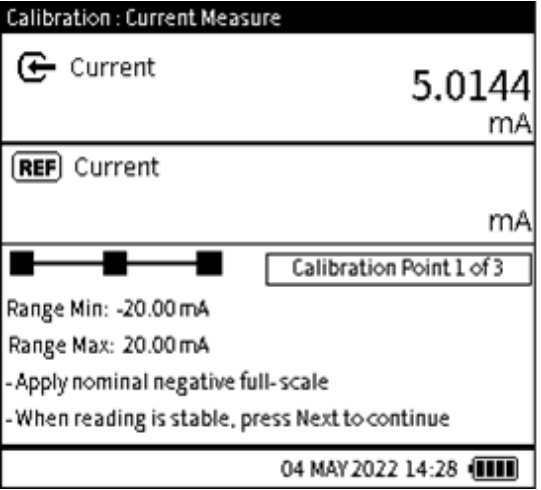
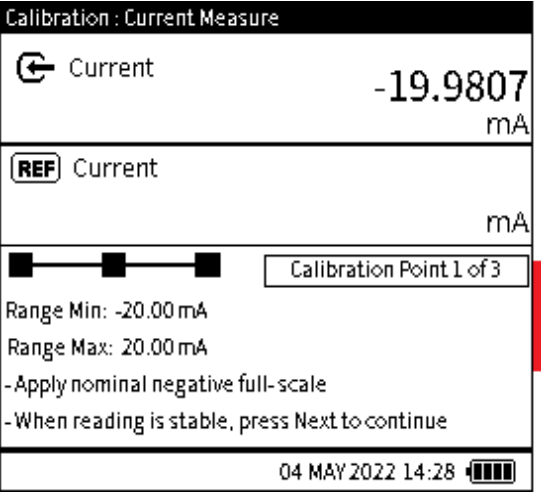

To calibrate an electrical function (Current Measure is used in this example), make sure the electrical connection between the DPI 610E and the external calibrated equipment is correct (See Section 6.2.9 on page 88 for Current Measure electrical connection diagram).

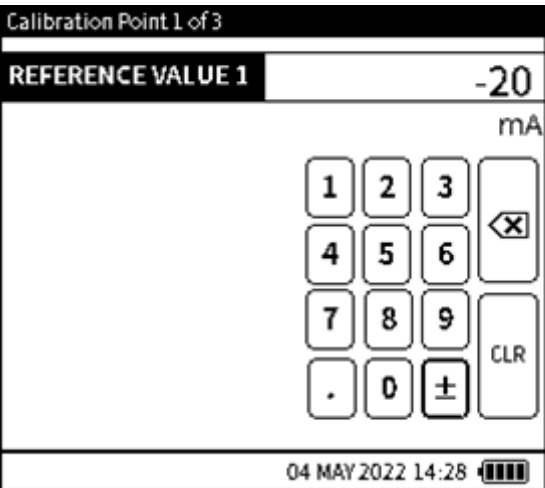
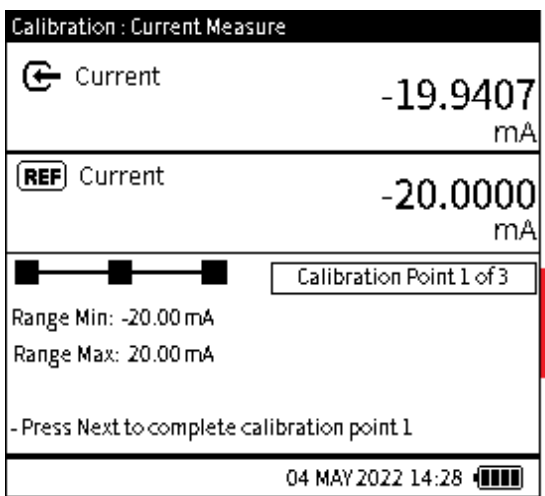
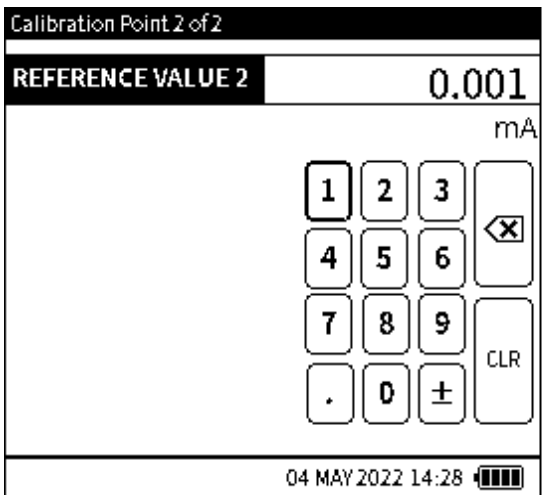
<p>Step 1</p>	 <p>The screenshot shows the 'Instrument Calibration' menu. The option '> PERFORM CALIBRATION' is highlighted with a red box. Other options include 'INTERNAL PRESSURE SENSOR STATUS', 'SET CALIBRATION DATE & INTERVAL', 'BACKUP CALIBRATION', 'RESTORE CALIBRATION', and 'RESTORE FACTORY CALIBRATION'. The status bar at the bottom shows '04 MAY 2022 14:28' and a battery icon. A red arrow points to the right.</p>	<p>Select PERFORM CALIBRATION from the Instrument Calibration menu.</p>												
<p>Step 2</p>	 <p>The screenshot shows the 'Perform Calibration' menu. The option '> Current' is highlighted with a red box. Other options include 'Voltage', 'Millivolts', 'Pressure', and 'Barometer'. The status bar at the bottom shows '04 MAY 2022 14:28' and a battery icon. A red arrow points to the right.</p>	<p>Select a FUNCTION option (e.g., Current).</p>												
<p>Step 3</p>	 <p>The screenshot shows the 'Perform Calibration' menu with a table structure. The 'FUNCTION' column has 'Current' selected (highlighted in black). The 'DIRECTION' column has 'Measure' highlighted with a red box. Other options in the 'FUNCTION' column include 'Voltage', 'Millivolts', 'Pressure', and 'Barometer'. Under 'Measure', there is an option '> Source'. The status bar at the bottom shows '04 MAY 2022 14:28' and a battery icon. A red arrow points to the right.</p> <table border="1" data-bbox="229 1415 778 1906"> <thead> <tr> <th>FUNCTION</th> <th>DIRECTION</th> </tr> </thead> <tbody> <tr> <td>Current</td> <td>Measure</td> </tr> <tr> <td>Voltage</td> <td>> Source</td> </tr> <tr> <td>Millivolts</td> <td></td> </tr> <tr> <td>Pressure</td> <td></td> </tr> <tr> <td>Barometer</td> <td></td> </tr> </tbody> </table>	FUNCTION	DIRECTION	Current	Measure	Voltage	> Source	Millivolts		Pressure		Barometer		<p>Select a DIRECTION option if applicable (e.g., Measure).</p>
FUNCTION	DIRECTION													
Current	Measure													
Voltage	> Source													
Millivolts														
Pressure														
Barometer														

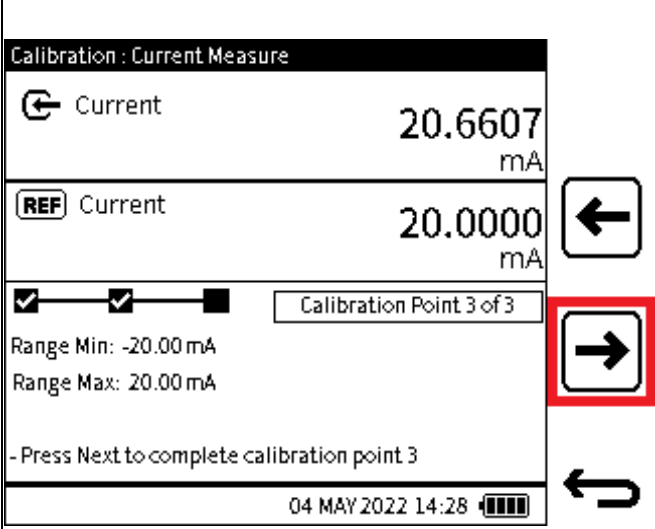
<p>Step 4</p>		<p>Select a RANGE option if applicable (e.g., 20 mA).</p> <p>Select ✓ to confirm.</p>
<p>Step 5</p>		<p>This screen has three sections. The top two sections cover:</p> <ul style="list-style-type: none"> The reference reading from an external calibrated equipment. The measured (or sourced) reading from the DPI 610E. <p>The bottom section provides the following information:</p> <ol style="list-style-type: none"> Function minimum range (or negative full-scale) value. Function maximum range (or positive full-scale) value Calibration procedure step status (visual status boxes and text status) User instructions for each step of the procedure.
<p>Step 6</p>		<p>To start the calibration, apply nominal negative full-scale Current (approximately -20 mA) as per the displayed instruction. This is the Calibration point 1.</p> <p>When the measured Current reading is stable, select the Next → icon to continue.</p> <p>Note:</p> <ul style="list-style-type: none"> All electrical measure functions require a 3-point calibration. Current Source function requires a 2-point calibration. Voltage source function requires a 1-point calibration.

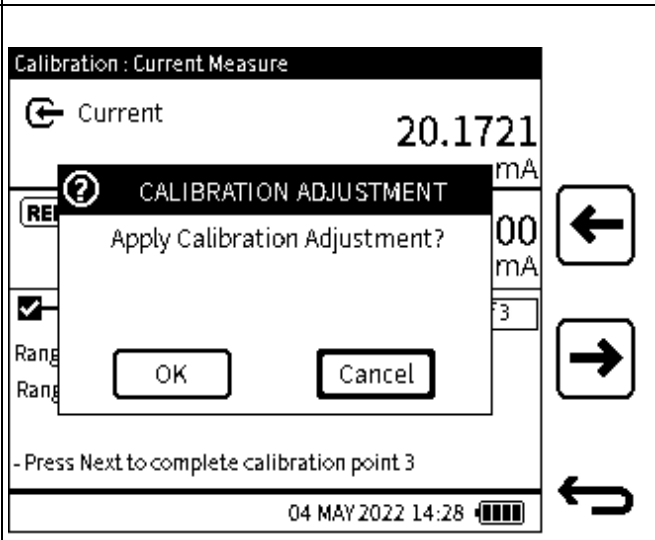
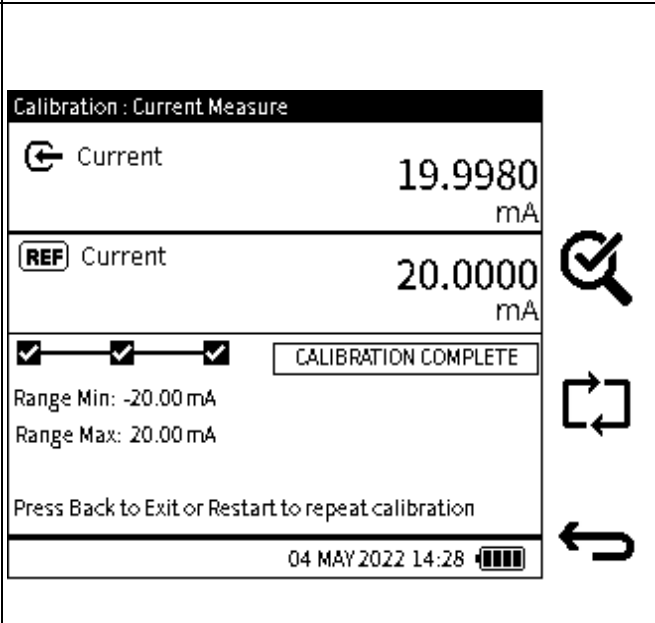
Chapter 13. Instrument Calibration

<p>Step 7</p>		<p>Enter the REFERENCE VALUE 1 value as displayed on the external calibrated equipment. Press the Tick ✓ softkey to confirm and return to the Calibration screen.</p>
<p>Step 8</p>		<p>Press the Next → softkey to complete Calibration point 1 and proceed to Calibration point 2.</p>
<p>Step 9</p>		<p>Apply Steps 6 to 8, but this time begin by applying the nominal zero Current (approximately 0 mA) to the DPI 610E. This completes Calibration point 2.</p>

<p>Step 10</p>		<p>Once again, apply Steps 6 to 8, but this time begin by applying the positive full-scale Current (approximately 20 mA) to the DPI 610E.</p> <p>Press the Next  softkey to complete Calibration point 3.</p>
<p>Step 11</p>		<p>A message window appears, requesting confirmation to perform the calibration adjustment based on the calibration points used in the procedure.</p> <p>Select OK to apply the calibration adjustment.</p> <p>Otherwise, select the Cancel button to return to the Calibration screen.</p>
<p>Step 12</p>		<p>If OK is selected, the CALIBRATION COMPLETE message appears in the status box, to confirm the adjustment has been made.</p> <p>At this stage, there are three icons for three ways to proceed. These are:</p> <ul style="list-style-type: none">  VERIFICATION softkey navigates to the Verification screen (see Step 13).  RESTART softkey allows the calibration procedure to be restarted if a repeat calibration is required.  BACK softkey exits the calibration procedure and returns the user to the Perform Calibration menu screen.

Chapter 13. Instrument Calibration

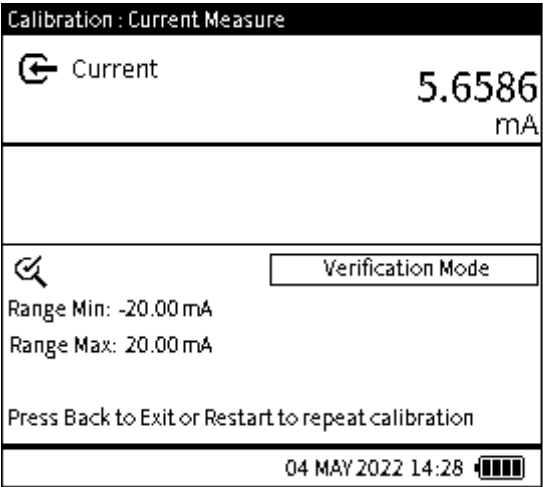
<p>Step 13</p>		<p>The Verification mode shows live reference and measured (or sourced) values. Here, different values or points within the measured (or sourced) range can be checked to verify the adjustment is satisfactory. Once verification is complete, select the Back icon to exit the calibration procedure or select the Restart softkey to repeat the calibration.</p>
----------------	---	--

13.2.2 Calibration - Internal Pressure Sensor



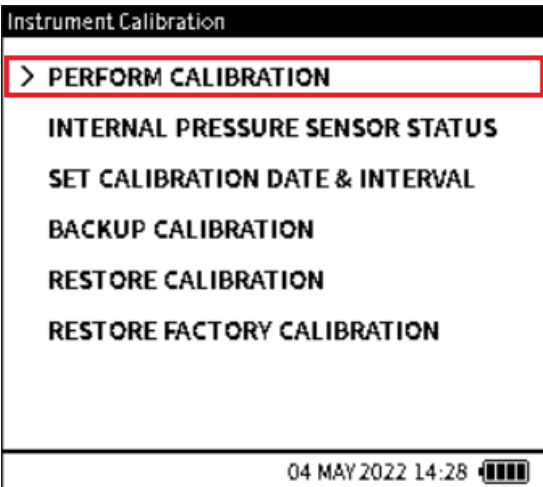
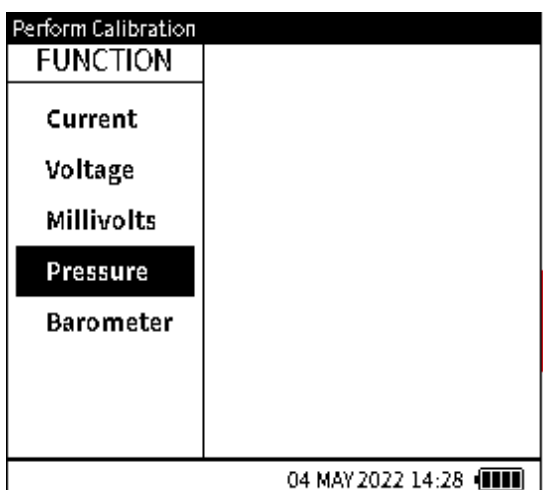

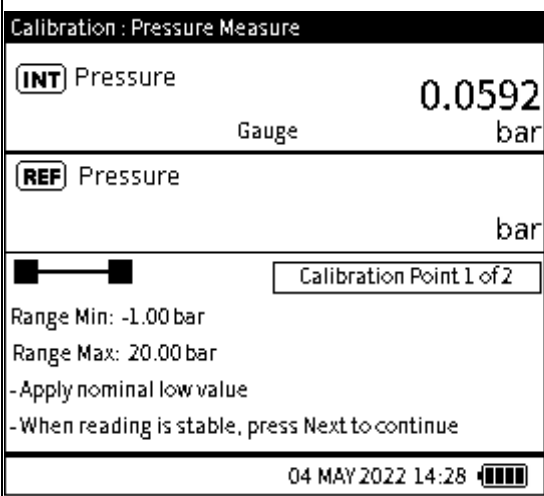
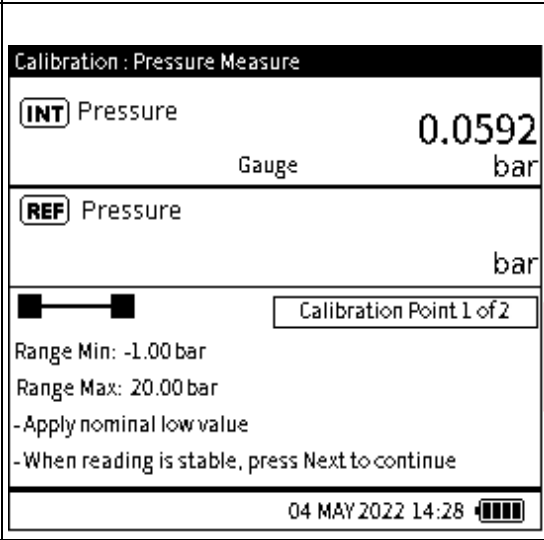
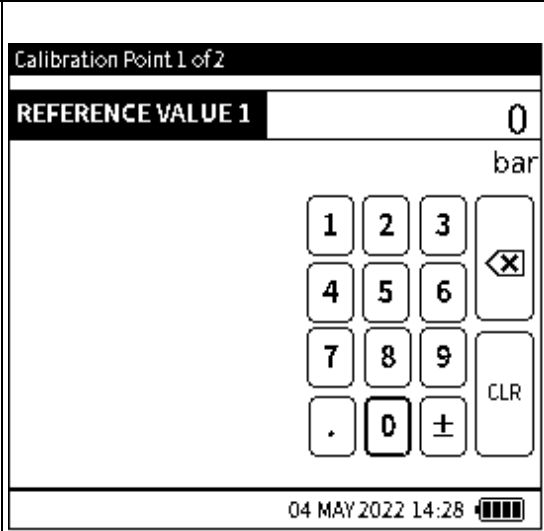

To calibrate the internal pressure sensor of the DPI 610E, make sure the correct pressure connection is made from the test port and the external calibrated pressure source. This sensor calibration should only be done by approved service centres and personnel.

<p>Step 1</p>		<p>Select PERFORM CALIBRATION from the Instrument Calibration menu.</p>
<p>Step 2</p>		<p>Select Pressure function. Select ✓ to confirm.</p>

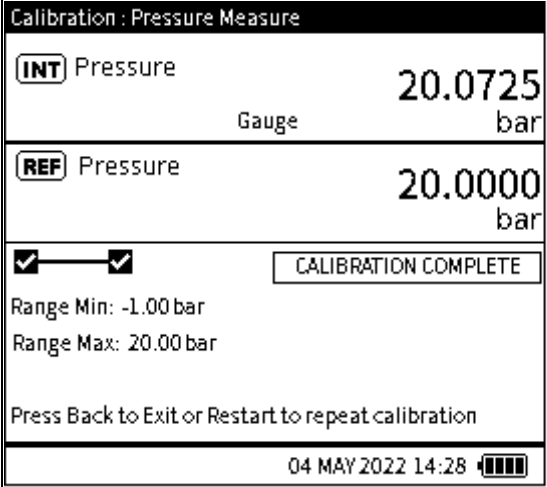
<p>Step 3</p>		<p>This screen has three sections. The top two sections cover:</p> <ul style="list-style-type: none"> • The reference reading from external calibrated equipment. • The measured (or sourced) reading from the DPI 610E. <p>The bottom section provides the following information:</p> <ol style="list-style-type: none"> 1. Function minimum range (or negative full-scale) value. 2. Function maximum range (or positive full-scale) value 3. Calibration procedure step status (visual status boxes and text status) 4. User instructions for each step of the procedure.
<p>Step 4</p>		<p>To start the calibration, apply nominal negative full-scale or zero pressure as per the displayed instruction. This is Calibration point 1. When the measured Pressure reading is stable, select the Next icon to continue. Note: Pressure sensor calibration requires two valid calibration points.</p>
<p>Step 5</p>		<p>Enter REFERENCE VALUE 1 as displayed on the external calibrated equipment. Press the Tick ✓ softkey to confirm and return to the Calibration screen.</p>

Chapter 13. Instrument Calibration

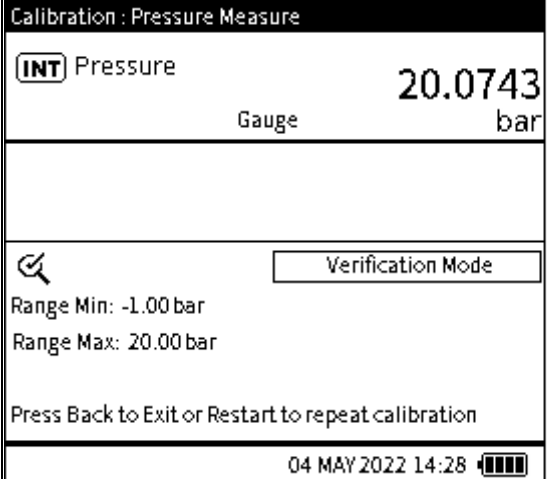
<p>Step 6</p>		<p>Press the Next softkey to complete Calibration point 1 and proceed to Calibration point 2.</p>
<p>Step 7</p>		<p>Apply Steps 4 to 6, but this time begin by applying the nominal positive full-scale pressure to the DPI610E.</p> <p>Press the Next softkey to complete Calibration point 2 and proceed to Calibration point 3.</p>
<p>Step 8</p>		<p>A message window appears, requesting confirmation to perform the calibration adjustment based on the calibration points used in the procedure. Select OK to apply the calibration adjustment. Otherwise, select the Cancel button to return to the Calibration screen.</p>





<p>Step 9</p>	 <p>The screenshot shows the 'Calibration : Pressure Measure' screen. It displays two pressure readings: 'INT Pressure' at 20.0725 bar and 'REF Pressure' at 20.0000 bar. Below the readings, there are two checked checkboxes and a 'CALIBRATION COMPLETE' button. The range is set to 'Range Min: -1.00 bar' and 'Range Max: 20.00 bar'. At the bottom, it says 'Press Back to Exit or Restart to repeat calibration' and shows the date '04 MAY 2022 14:28' with a battery icon.</p>	<p>If OK is selected, the CALIBRATION COMPLETE message appears in the status box, to confirm the adjustment has been made.</p> <p>At this stage, there are three icons for three ways to proceed. These are:</p> <ul style="list-style-type: none">  VERIFICATION softkey navigates to the Verification screen (see Step 13).  RESTART softkey allows the calibration procedure to be restarted if a repeat calibration is required.  BACK softkey exits the calibration procedure and returns the user to the Perform Calibration menu screen.
<p>Step 10</p>	 <p>The screenshot shows the 'Calibration : Pressure Measure' screen in verification mode. It displays 'INT Pressure' at 20.0743 bar. Below the reading, there is a magnifying glass icon and a 'Verification Mode' button. The range is set to 'Range Min: -1.00 bar' and 'Range Max: 20.00 bar'. At the bottom, it says 'Press Back to Exit or Restart to repeat calibration' and shows the date '04 MAY 2022 14:28' with a battery icon.</p>	<p>The Verification mode shows live reference and measured (or sourced) values. Here, different values or points within the measured (or sourced) range can be checked to verify the adjustment is satisfactory.</p> <p>Once verification is complete, select the Back  icon to exit the calibration procedure or select the Restart  softkey to repeat the calibration.</p>

Chapter 13. Instrument Calibration

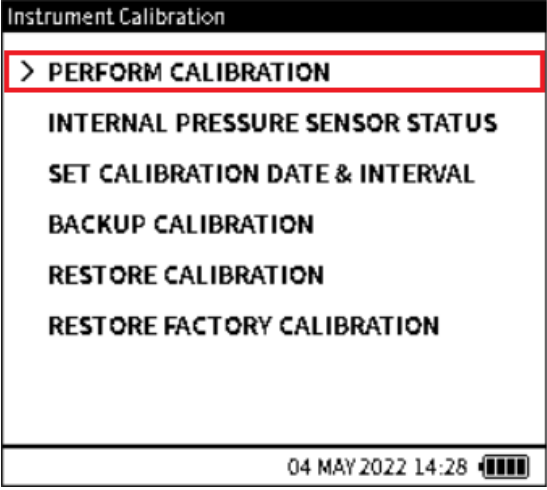
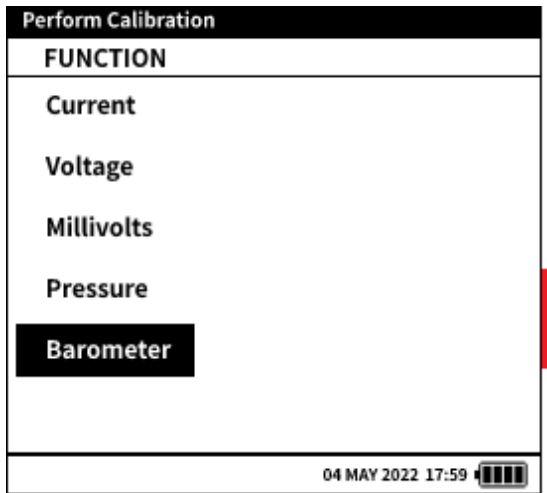

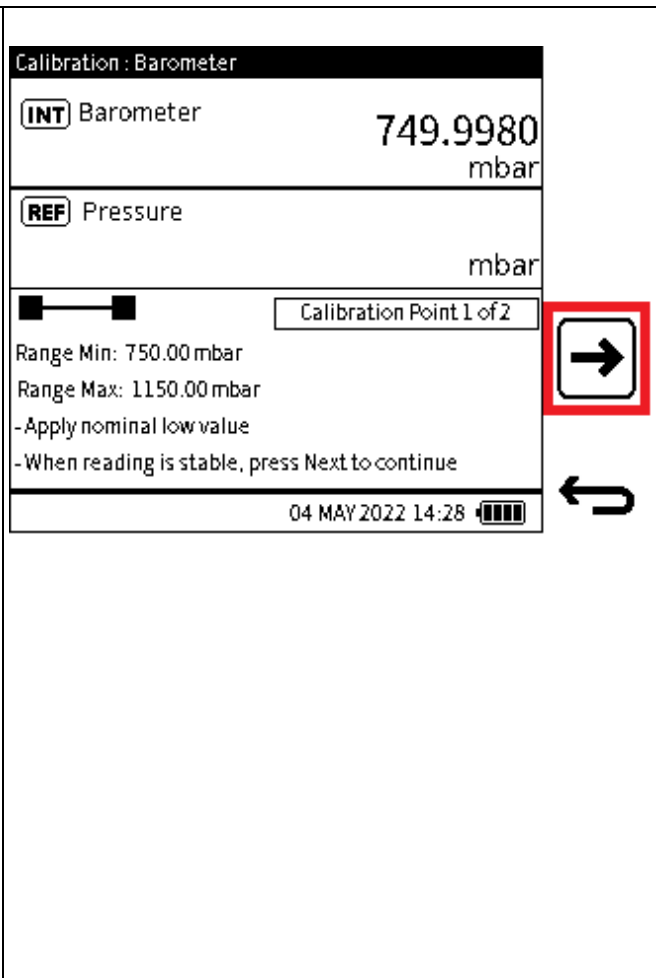
13.2.3 Calibration – Internal Barometer

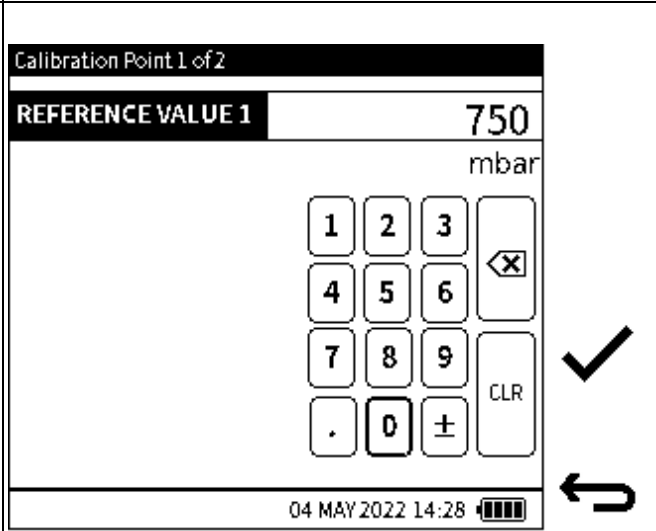
To calibrate the internal barometer sensor of the DPI 610E, make sure the correct pressure connection is made from the barometer port and the external calibrated pressure source. This sensor calibration should only be done by approved service centres and personnel.







Step 1		Select PERFORM CALIBRATION from the Instrument Calibration menu.
Step 2		Select Barometer function. Select ✓ to confirm.

<p>Step 3</p>		<p>The Calibration - Barometer screen has three sections.</p> <p>The top two sections show:</p> <ul style="list-style-type: none"> • The reference reading from external calibrated equipment. • The measured (or sourced) reading from the DPI 610E. <p>The bottom section gives the following information:</p> <ol style="list-style-type: none"> 1. Function minimum range (or negative full-scale) value. 2. Function maximum range (or positive full-scale) value 3. Calibration procedure step status (visual status boxes and text status) 4. User instructions for each step of the procedure. <p>To start the calibration, apply nominal negative full-scale or zero pressure as per the displayed instruction. This is Calibration point 1.</p> <p>When the measured Pressure reading is stable, select the Next  icon to continue.</p> <p>Note: Barometer sensor calibration requires two valid calibration points.</p>
<p>Step 4</p>		<p>Enter REFERENCE VALUE 1 as displayed on the external calibrated equipment. Press the Tick  softkey to confirm and return to the Calibration screen.</p>

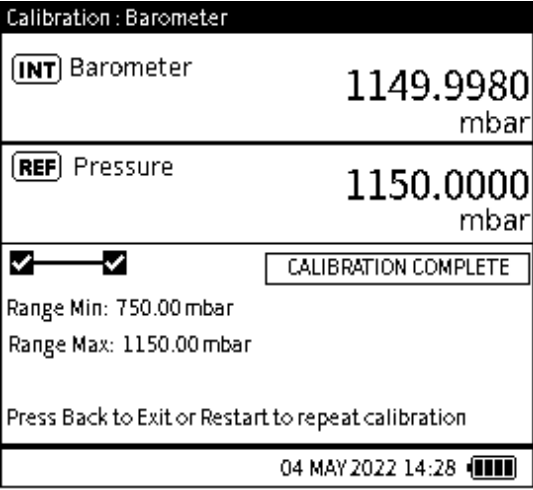
Chapter 13. Instrument Calibration

<p>Step 5</p>		<p>Press the Next  softkey to complete Calibration point 1 and proceed to Calibration point 2.</p>
<p>Step 6</p>		<p>Apply Steps 3 to 5, but this time begin by applying the nominal positive full-scale pressure to the DPI 610E. When the measured Pressure reading is stable, select the Next  icon to continue. This completes Calibration point 2.</p>
<p>Step 7</p>		<p>After pressing Next from the previous step, a message window will appear, requesting confirmation to perform the calibration adjustment based on the calibration points used in the procedure. Select OK to apply the calibration adjustment. Otherwise, select the Cancel button to return to the Calibration screen</p>

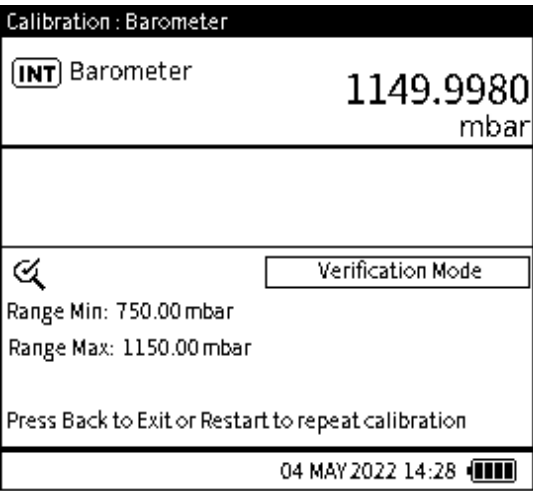
PERFORM CALIBRATION

<p>Step 8</p>	 <p>The screenshot shows the 'Calibration : Barometer' screen. It displays 'INT Barometer' with a value of 1149.9980 mbar and 'REF Pressure' with a value of 1150.0000 mbar. Below these, there are two checkboxes, both of which are checked. A 'CALIBRATION COMPLETE' button is visible. The screen also shows 'Range Min: 750.00 mbar' and 'Range Max: 1150.00 mbar'. At the bottom, it says 'Press Back to Exit or Restart to repeat calibration' and shows the date '04 MAY 2022 14:28' and a battery icon.</p>	<p>If OK is selected, the CALIBRATION COMPLETE message appears in the status box, to confirm the adjustment has been made.</p> <p>At this stage, there are three icons for three ways to proceed. These are:</p> <ul style="list-style-type: none">  VERIFICATION softkey navigates to the Verification screen (see Step 9).  RESTART softkey allows the calibration procedure to be restarted if a repeat calibration is required.  BACK softkey exits the calibration procedure and returns the user to the Perform Calibration menu screen.
<p>Step 9</p>	 <p>The screenshot shows the 'Calibration : Barometer' screen in Verification Mode. It displays 'INT Barometer' with a value of 1149.9980 mbar. Below this, there is a 'Verification Mode' button. The screen also shows 'Range Min: 750.00 mbar' and 'Range Max: 1150.00 mbar'. At the bottom, it says 'Press Back to Exit or Restart to repeat calibration' and shows the date '04 MAY 2022 14:28' and a battery icon.</p>	<p>The Verification mode shows live reference and measured (or sourced) values.</p> <p>Here, different values or points within the measured (or sourced) range can be checked to verify the adjustment is satisfactory.</p> <p>Once verification is complete, select the Back  button to exit the Calibration procedure or select the Restart  softkey to repeat the calibration.</p>

13.3 INTERNAL PRESSURE SENSOR STATUS

The **Internal Pressure Sensor Status** screen (Figure 13-2) provides information about the instrument's internal pressure sensor:

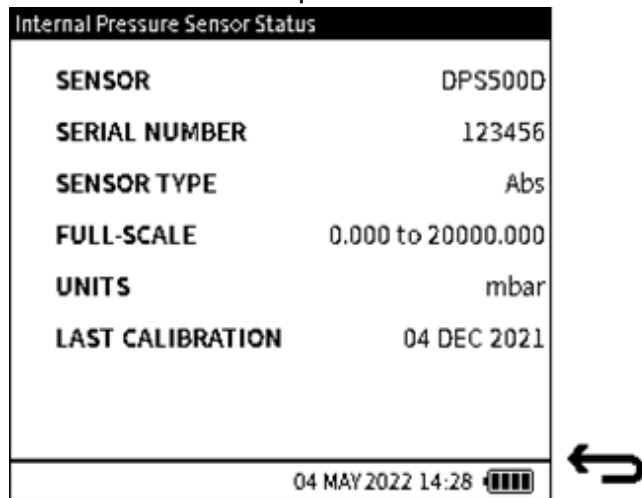
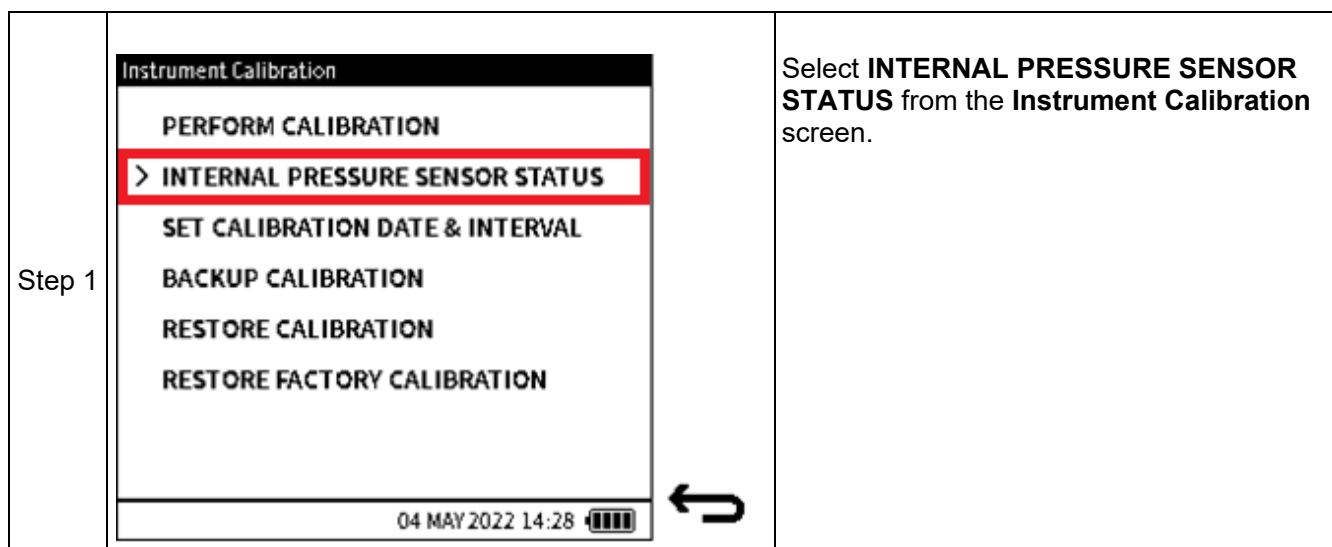

Figure 13-2: Instrument Status screen

To access the **Internal Pressure Sensor Status** screen (Figure 13-2), select **INTERNAL PRESSURE SENSOR STATUS** from the **Instrument Calibration** screen as shown below:



13.4 SET CALIBRATION DATE & INTERVAL

The following options are available in the **Instrument Calibration Date & Interval** screen:

Option	Description
LAST CALIBRATION	Set the date the instrument was last calibrated
CALIBRATION INTERVAL	Enable user notification by setting the number of days between the last calibration and the next scheduled calibration (default is 365 days)
CALIBRATION DUE	Enable user notification by setting a specific date to schedule next calibration (default is based on the date of the last calibration and the specified calibration interval)

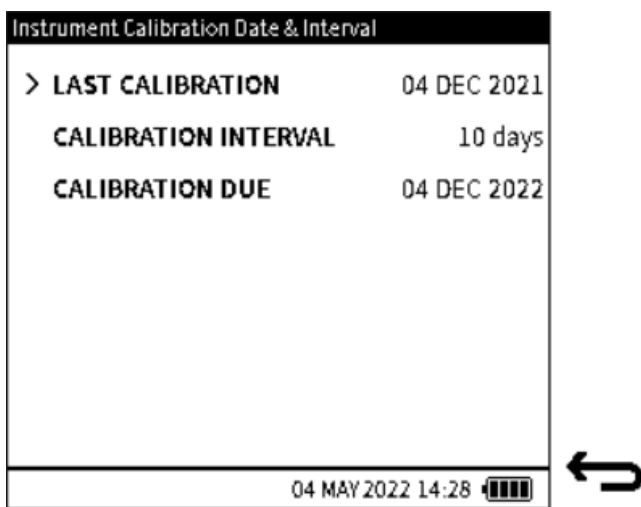
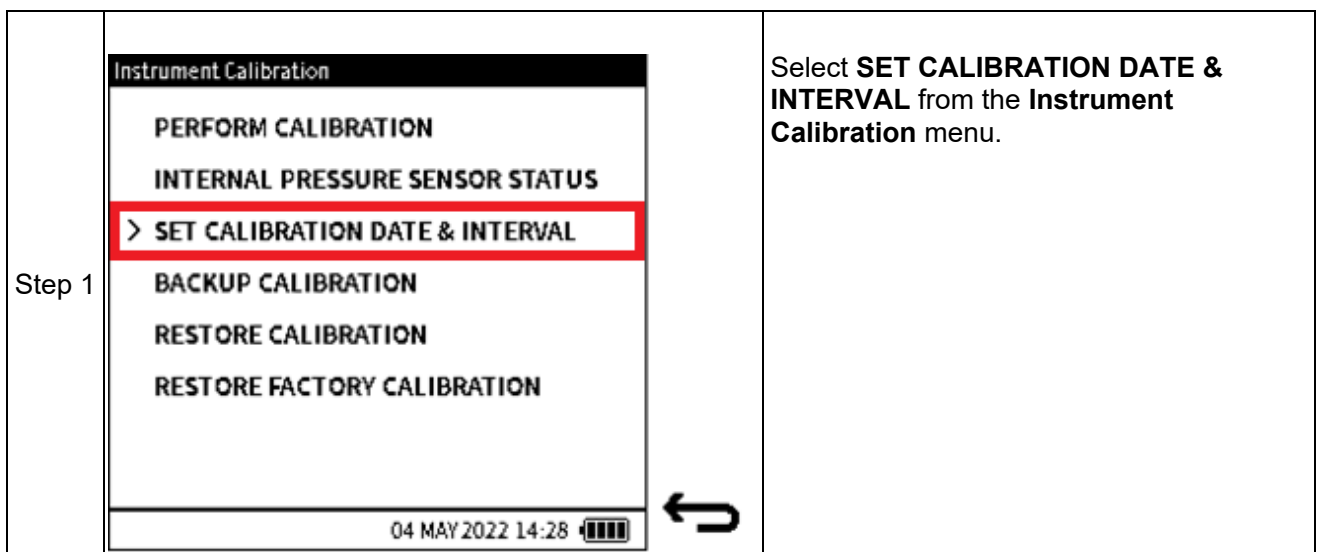

Figure 13-3: Instrument Calibration Date & Interval screen

To access the **Instrument Calibration Date & Interval** screen (Figure 13-3), select **SET CALIBRATION DATE & INTERVAL** from the **Instrument Calibration** menu as shown below:



Chapter 13. Instrument Calibration

13.4.1 Change Last Calibration Date

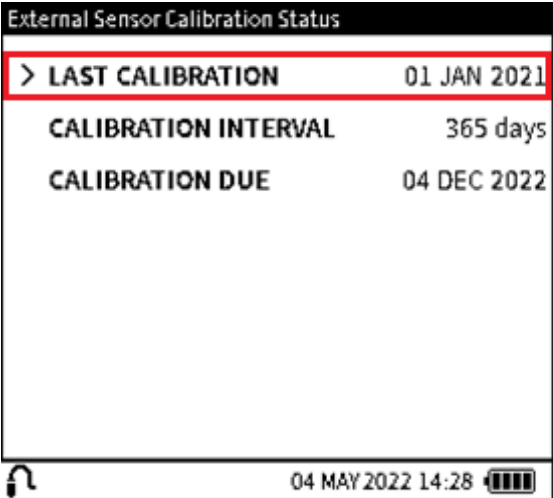
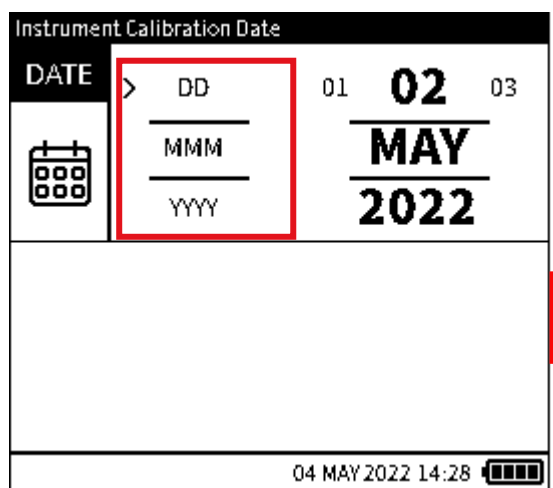
Step 1		Select LAST CALIBRATION from the Instrument Calibration Date & Interval screen.
Step 2		Select the required day, month, and year, as required (see Chapter 1.19.3 on page 25). To change the value, select the row of the variable. Press the value on the left of the current value to decrease the value and the value on the right to increase the value. Repeat pressing of either left or right value decreases or increases the selected current value. Select ✓ to confirm the changes.

SET CALIBRATION DATE & INTERVAL

13.4.2 Change Calibration Interval

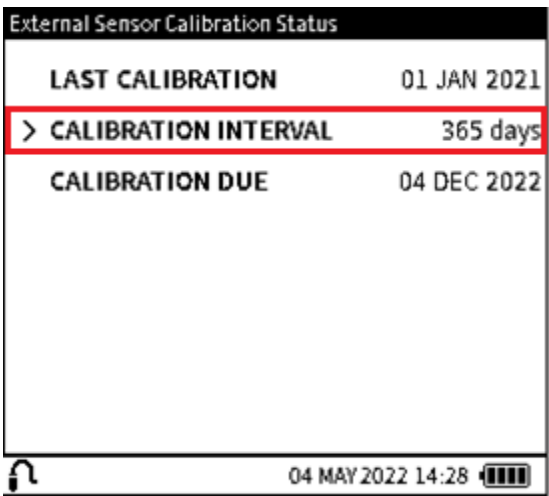
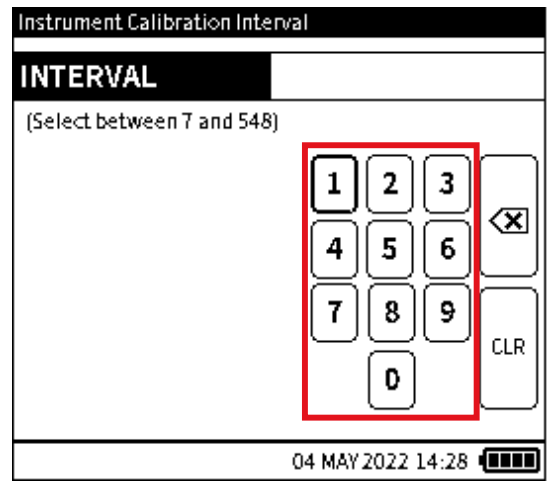
Step 1		Select CALIBRATION INTERVAL from the Instrument Calibration Date & Interval screen.
Step 2		Enter a calibration interval between 7 and 548 (days). Select ✓ to confirm.

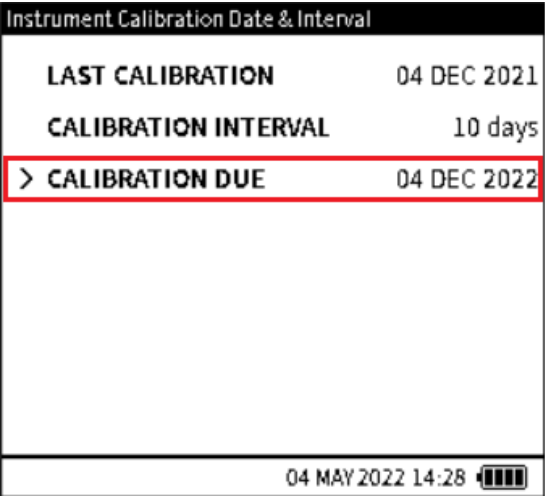
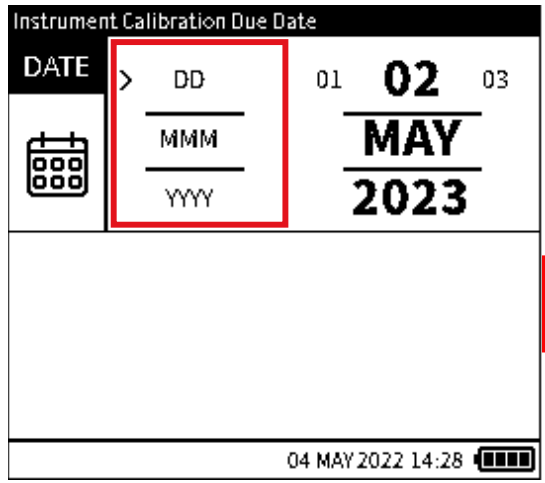

Chapter 13. Instrument Calibration

13.4.3 Change Calibration Due Date

Step 1	 <p>Instrument Calibration Date & Interval</p> <table><tr><td>LAST CALIBRATION</td><td>04 DEC 2021</td></tr><tr><td>CALIBRATION INTERVAL</td><td>10 days</td></tr><tr><td>> CALIBRATION DUE</td><td>04 DEC 2022</td></tr></table> <p>04 MAY 2022 14:28</p>	LAST CALIBRATION	04 DEC 2021	CALIBRATION INTERVAL	10 days	> CALIBRATION DUE	04 DEC 2022	<p>Select CALIBRATION DUE from the Instrument Calibration Date & Interval screen.</p>
LAST CALIBRATION	04 DEC 2021							
CALIBRATION INTERVAL	10 days							
> CALIBRATION DUE	04 DEC 2022							
Step 2	 <p>Instrument Calibration Due Date</p> <p>DATE > DD 01 02 03</p> <p>MMM MAY</p> <p>YYYY 2023</p> <p>04 MAY 2022 14:28</p>	<p>Select the required day, month and year, as required (see Chapter 1.19.3 on page 25). To change the value, select the row of the variable. Press the value on the left of the current value to decrease the value and the value on the right to increase the value. Repeat pressing of either left or right value decreases or increases the selected current value.</p> <p>Select ✓ to confirm the changes.</p>						

13.5 BACKUP CALIBRATION

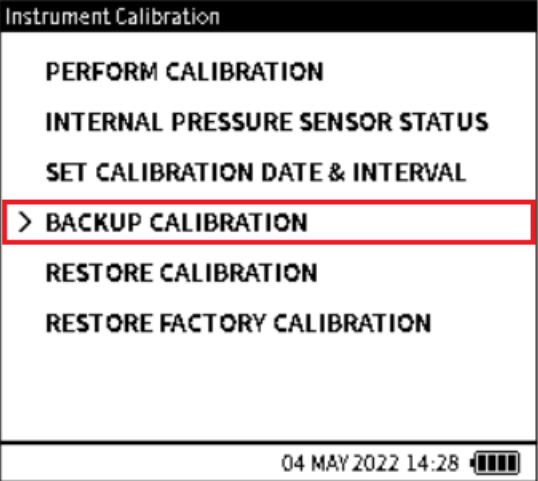
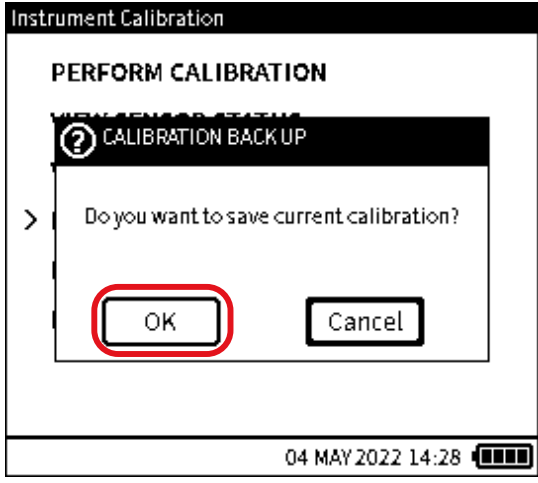
The current calibration configuration can be saved in the form as a Backup file. This Backup file can be used to restore the instrument’s calibration if necessary.

<p>Step 1</p>	 <p>The screenshot shows the 'Instrument Calibration' menu with the following options: PERFORM CALIBRATION, INTERNAL PRESSURE SENSOR STATUS, SET CALIBRATION DATE & INTERVAL, > BACKUP CALIBRATION (highlighted with a red box), RESTORE CALIBRATION, and RESTORE FACTORY CALIBRATION. The status bar at the bottom shows '04 MAY 2022 14:28' and a battery icon. A curved arrow points to the right.</p>	<p>Select BACKUP CALIBRATION from the Instrument Calibration Date & Interval screen. Note: Only one user calibration configuration can be backed up at any one time.</p>
<p>Step 2</p>	 <p>The screenshot shows a dialog box titled 'CALIBRATION BACKUP' with a question mark icon. The text inside asks 'Do you want to save current calibration?'. There are two buttons: 'OK' (circled in red) and 'Cancel'. The status bar at the bottom shows '04 MAY 2022 14:28' and a battery icon. A curved arrow points to the right.</p>	<p>Select OK to confirm backup.</p>
<p>Step 3</p>	 <p>The screenshot shows a notification dialog box titled 'BACKUP CALIBRATION' with an information icon. The text inside says 'Calibration backup successful' and '04_DEC_2021_current'. There is an 'OK' button. The status bar at the bottom shows '04 MAY 2022 14:28' and a battery icon. A curved arrow points to the right.</p>	<p>Check that the CALIBRATION BACKUP notification appears. If the notification does not appear, repeat steps 1 and 2.</p>

13.6 RESTORE CALIBRATION

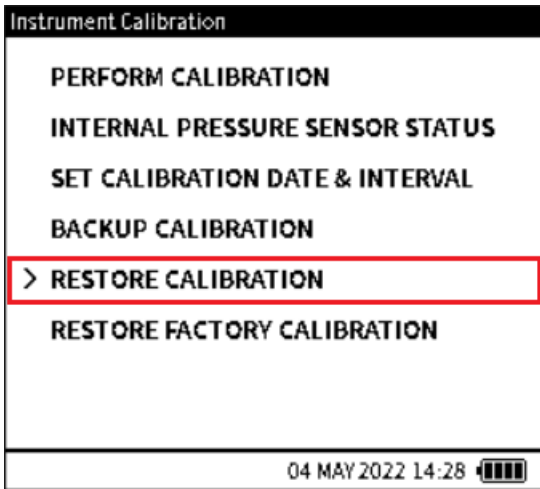
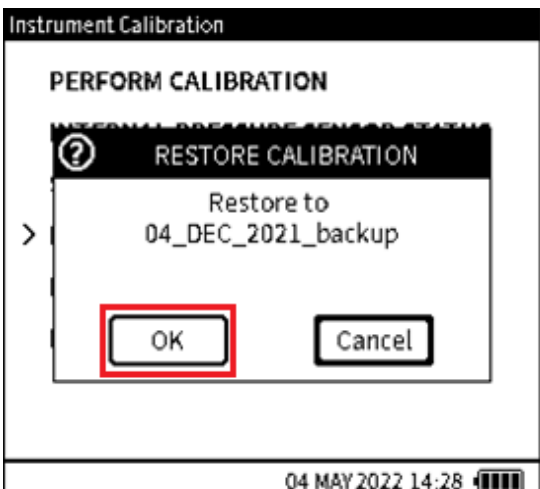
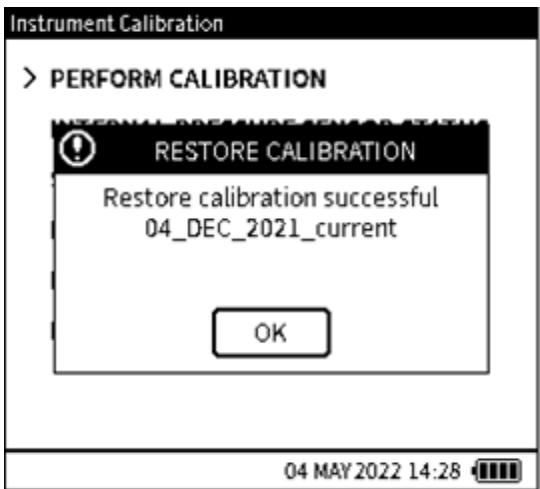

This function allows the user to restore a previous calibration configuration.

Note: A valid calibration backup file must exist, to enable this calibration restore feature to be used. See Section 13.5 on page 247 for how to create this file.

Step 1	 <p>The screenshot shows the 'Instrument Calibration' menu with the following options: PERFORM CALIBRATION, INTERNAL PRESSURE SENSOR STATUS, SET CALIBRATION DATE & INTERVAL, BACKUP CALIBRATION, > RESTORE CALIBRATION (highlighted with a red box), and RESTORE FACTORY CALIBRATION. The status bar at the bottom shows '04 MAY 2022 14:28' and a battery icon. A curved arrow points from the bottom right of the screenshot to the right-hand text box.</p>	Select RESTORE CALIBRATION from the Instrument Calibration menu.
Step 2	 <p>The screenshot shows a dialog box titled 'RESTORE CALIBRATION' with a question mark icon. The text inside says 'Restore to 04_DEC_2021_backup'. At the bottom are 'OK' and 'Cancel' buttons. The 'OK' button is highlighted with a red box. The status bar at the bottom shows '04 MAY 2022 14:28' and a battery icon. A curved arrow points from the bottom right of the screenshot to the right-hand text box.</p>	Select OK to confirm restore.
Step 3	 <p>The screenshot shows a dialog box titled 'RESTORE CALIBRATION' with an information icon. The text inside says 'Restore calibration successful 04_DEC_2021_current'. At the bottom is an 'OK' button. The status bar at the bottom shows '04 MAY 2022 14:28' and a battery icon. A curved arrow points from the bottom right of the screenshot to the right-hand text box.</p>	Check that the CALIBRATION RESTORE notification appears. If the notification does not appear, repeat steps 1 and 2.

13.7 RESTORE FACTORY CALIBRATION

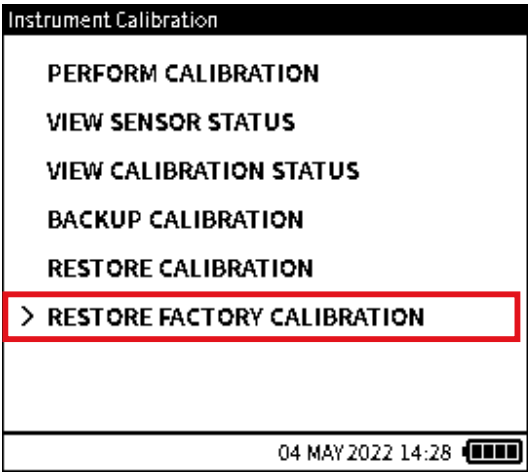
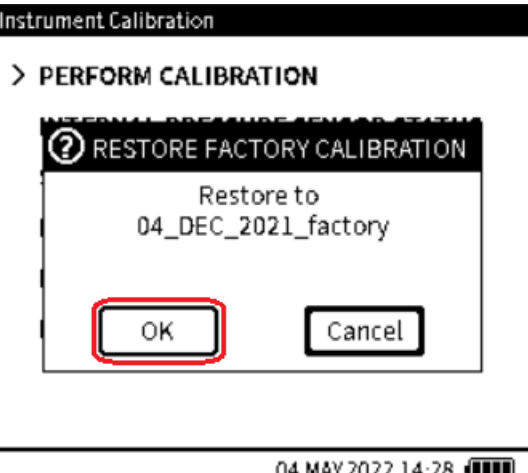
The instrument has its factory calibration saved internally before it is shipped from our factory. If for any reason (for example, if an incorrect calibration adjustment has been made), the instrument needs its calibration resetting to the point at which it was shipped, the **Restore Factory Calibration** feature can be used

<p>Step 1</p>	 <p>The screenshot shows the 'Instrument Calibration' menu with the following options: PERFORM CALIBRATION, VIEW SENSOR STATUS, VIEW CALIBRATION STATUS, BACKUP CALIBRATION, RESTORE CALIBRATION, and > RESTORE FACTORY CALIBRATION. The last option is highlighted with a red box. The status bar at the bottom shows the date and time '04 MAY 2022 14:28' and a battery icon.</p>	<p>Select RESTORE FACTORY CALIBRATION from the Instrument Calibration screen.</p>
<p>Step 2</p>	 <p>The screenshot shows the 'Instrument Calibration' menu with '> PERFORM CALIBRATION' selected. A dialog box titled 'RESTORE FACTORY CALIBRATION' is displayed, asking to 'Restore to 04_DEC_2021_factory'. The dialog has 'OK' and 'Cancel' buttons. The 'OK' button is highlighted with a red box. The status bar at the bottom shows the date and time '04 MAY 2022 14:28' and a battery icon.</p>	<p>A valid factory calibration file will be automatically retrieved and displayed in the popup message. Select OK to confirm restore.</p>
<p>Step 3</p>	 <p>The screenshot shows the 'Instrument Calibration' menu with '> PERFORM CALIBRATION' selected. A dialog box titled 'RESTORE FACTORY CALIBRATION' is displayed, showing the message 'Restore factory calibration successful 04_DEC_2021_current'. The dialog has an 'OK' button. The status bar at the bottom shows the date and time '04 MAY 2022 14:28' and a battery icon.</p>	<p>Check that the FACTORY CALIBRATION RESTORE notification appears.</p>

13.8 EXTERNAL PRESSURE SENSOR CALIBRATION MENU

See Section 13.1 on page 226 for how to access the **Calibration** menu from the Dashboard.

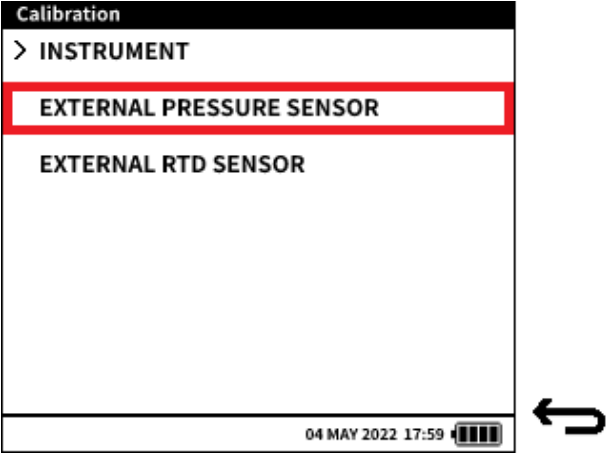
Step 1		<p>Select EXTERNAL PRESSURE SENSOR from the main Calibration screen.</p> <p>Note: To see the External Pressure Sensor option, the EXT Pressure function must be already configured in the Calibrator menu and the sensor connected successfully. See Section 8 on page 141.</p>
--------	---	---

13.8.1 PERFORM CALIBRATION

To calibrate the external pressure sensor PM700E using the DPI 610E, MAKE sure the correct pressure connection is made from the sensor and the external calibrated pressure source. Also, ensure the sensor is connected to the **EXT SENSOR** port on the DPI 610E using the sensor cable supplied. This sensor calibration should only be done by approved service centres and personnel.

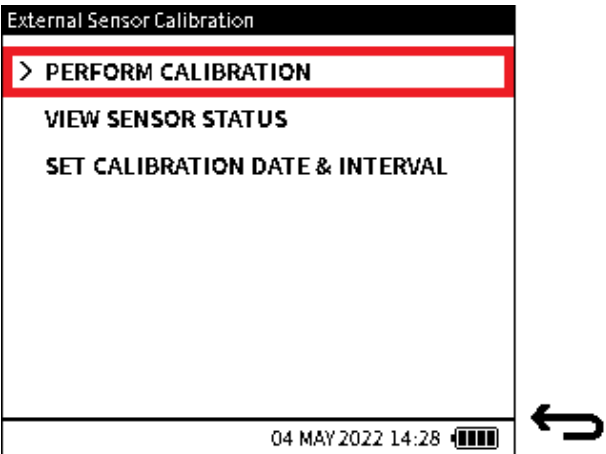
Step 1		<p>Select PERFORM CALIBRATION from the External Sensor Calibration menu screen.</p>
--------	---	---

EXTERNAL PRESSURE SENSOR CALIBRATION MENU

Step 2		<p>The calibration procedure of the external PM700E sensor is like that of the DPI 610E internal pressure sensor. See Section 13.2.2 on page 234.</p>
--------	--	---

13.8.2 VIEW EXTERNAL PRESSURE SENSOR STATUS

The **External Pressure Sensor Status** screen (Figure 13-4) provides information about the instrument's internal pressure sensor.

Figure 13-4: External Pressure Sensor Status

To access the **External Pressure Sensor Status** screen:

Step 1		<p>Select VIEW SENSOR STATUS from the EXTERNAL PRESSURE SENSOR Calibration screen.</p>
--------	--	--

Chapter 13. Instrument Calibration

13.8.3 SET CALIBRATION DATE & INTERVAL

The **External Pressure Sensor Calibration Date & Interval** screen provides the following options:

Option	Description
LAST CALIBRATION	Set the date the instrument was last calibrated
CALIBRATION INTERVAL	Enable user notification by setting the number of days between the last calibration and the next scheduled calibration (default is 365 days)
CALIBRATION DUE	Enable user notification by setting a specific date to schedule next calibration (default is based on the date of the last calibration and the specified calibration interval)

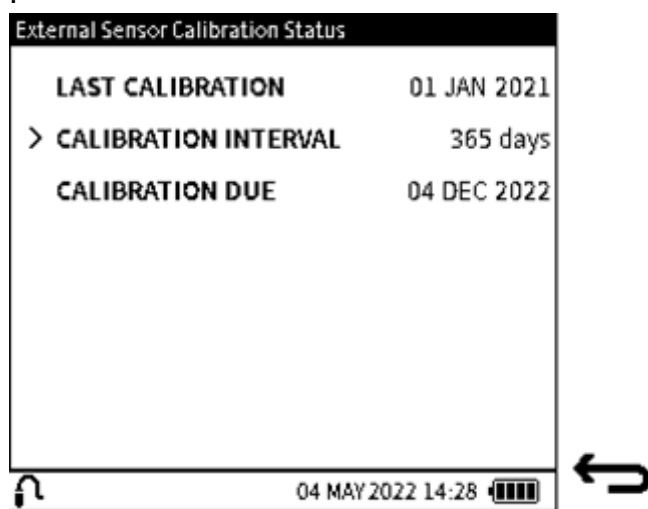

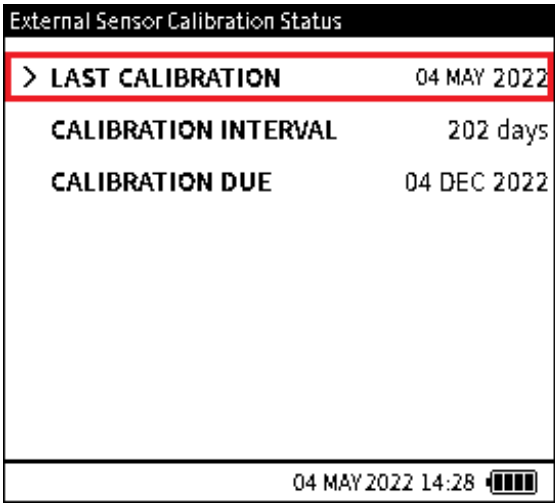

Figure 13-5: External Sensor Calibration Date & Interval Screen

To access the **SET CALIBRATION DATE & INTERVAL** screen:

Step 1	<p>The screenshot shows the 'External Sensor Calibration' menu with three options: 'PERFORM CALIBRATION', 'VIEW SENSOR STATUS', and '> SET CALIBRATION DATE & INTERVAL'. The third option is highlighted with a red border. The bottom of the screen shows a status bar with the date and time '04 MAY 2022 14:28' and a battery icon. A curved arrow points from the bottom right of the screen towards the caption.</p>	Select SET CALIBRATION DATE & INTERVAL screen from the External Sensor Calibration screen.
--------	--	--

EXTERNAL PRESSURE SENSOR CALIBRATION MENU

13.8.3.1 Change LAST CALIBRATION Date

Step 1	 <p>The screenshot shows the 'External Sensor Calibration Status' menu. The 'LAST CALIBRATION' option is highlighted with a red box. Below it are 'CALIBRATION INTERVAL' (202 days) and 'CALIBRATION DUE' (04 DEC 2022). The status bar at the bottom shows '04 MAY 2022 14:28' and a battery icon. A red arrow points to the 'LAST CALIBRATION' option.</p>	Select LAST CALIBRATION from the External Sensor Calibration Status screen.
Step 2	 <p>The screenshot shows the 'Date of Calibration' screen. The date is set to 31 01 2021 (DD, MM, YYYY). A red box highlights the checkmark icon at the bottom right. The status bar at the bottom shows '04 MAY 2022 14:28' and a battery icon. A red arrow points to the checkmark icon.</p>	Select the required day, month, and year, as required (see Chapter 1.19.3 on page 25). To change the value, select the row of the variable. Press the value on the left of the current value to decrease the value and the value on the right to increase the value. Repeat pressing of either left or right value decreases or increases the selected value. Select ✓ to confirm the changes.

Chapter 13. Instrument Calibration

13.8.3.2 Change CALIBRATION INTERVAL

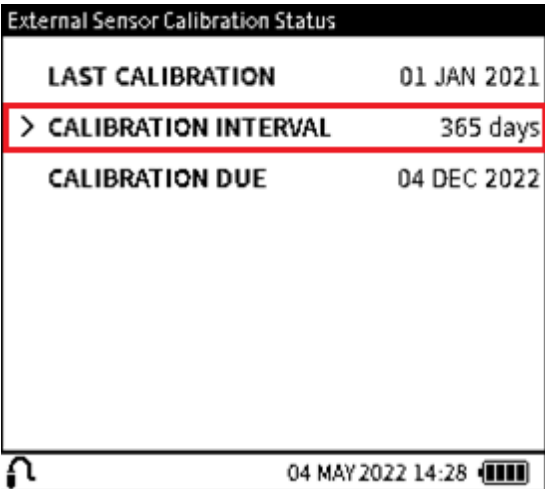
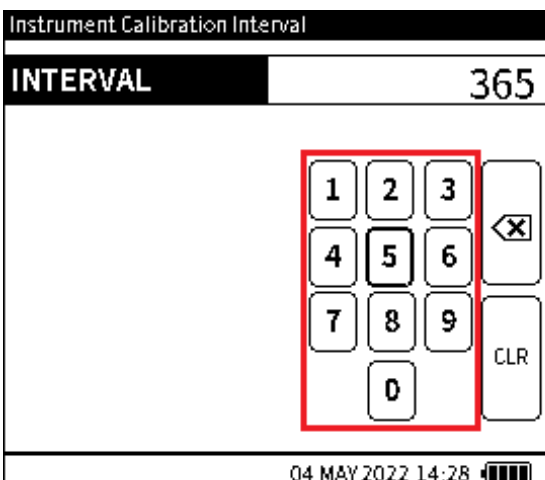
Step 1		Select CALIBRATION INTERVAL from the External Pressure Sensor Status screen.
Step 2		Enter a calibration interval between 7 and 548 (days). Select ✓ to confirm.

EXTERNAL PRESSURE SENSOR CALIBRATION MENU

13.8.3.3 Change CALIBRATION DUE Date

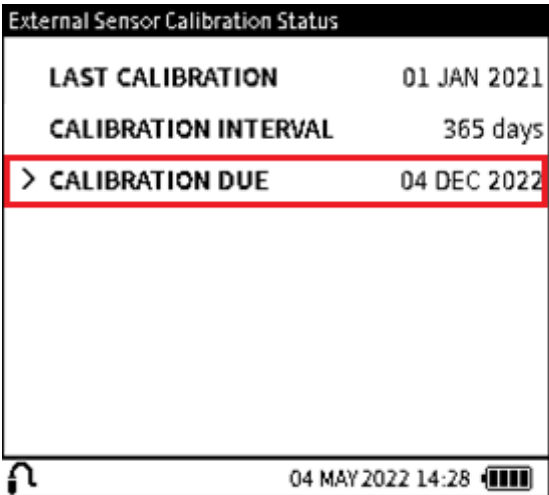
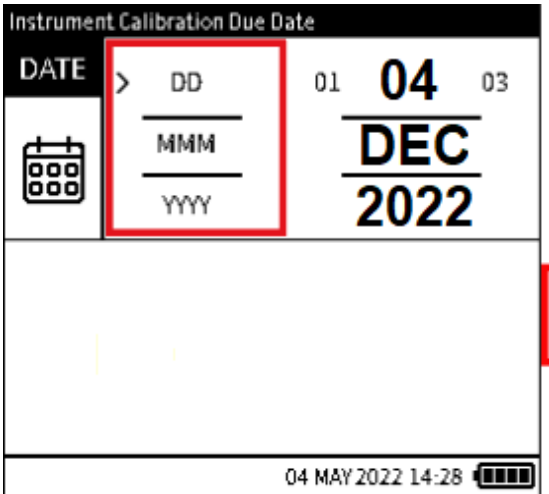
Step 1	 <p>The screenshot shows the 'External Sensor Calibration Status' menu. It lists 'LAST CALIBRATION' as 01 JAN 2021, 'CALIBRATION INTERVAL' as 365 days, and 'CALIBRATION DUE' as 04 DEC 2022. The 'CALIBRATION DUE' option is highlighted with a red box. A red arrow points to the right from the bottom right of the screen.</p>	<p>Select CALIBRATION DUE from the Instrument Calibration Date & Interval screen.</p>
Step 2	 <p>The screenshot shows the 'Instrument Calibration Due Date' selection screen. It displays 'DATE' with a calendar icon, and three rows for selection: 'DD' (01 04 03), 'MMM' (DEC), and 'YYYY' (2022). The 'DD' row is highlighted with a red box. A red checkmark is shown to the right of the screen, and a red arrow points to the right from the bottom right.</p>	<p>Select the required day, month and year, as required (see Chapter 1.19.3 on page 25). To change the value, select the row of the variable. Press the value on the left of the current value to decrease the value and the value on the right to increase the value. Repeat pressing of either left or right value decreases or increases the selected current value.</p> <p>Select ✓ to confirm the changes.</p>

13.9 EXTERNAL RTD SENSOR CALIBRATION MENU

Refer to Section 8 on page 141 for how to configure the DPI 610E to recognize and use an external RTD sensor. This is necessary to enable the DPI 610E user interface to show the RTD sensor calibration options.

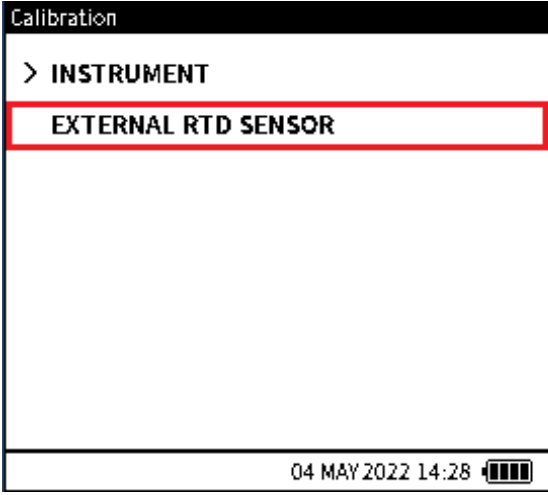
Step 1		<p>Select EXTERNAL RTD SENSOR from the main Calibration menu.</p> <p>Note: To see the External RTD Sensor option, the RTD function must be already configured in the Calibrator menu and the sensor connected successfully. Use the cross-reference given at the top of this page.</p>
--------	---	--

13.9.1 PERFORM CALIBRATION

To calibrate the external RTD sensor using the DPI 610E, make sure the correct connection is made between the RTD & RTD-Interface and the external calibrated resistance/temperature source. Also, make sure the RTD-Interface is connected to the **EXT SENSOR** port on the DPI 610E using the sensor cable supplied. This sensor calibration should only be done by approved service centres and personnel in accordance with the instructions in Section 8 on page 141. To access the **External Pressure Sensor Status** screen. Follow the steps below:

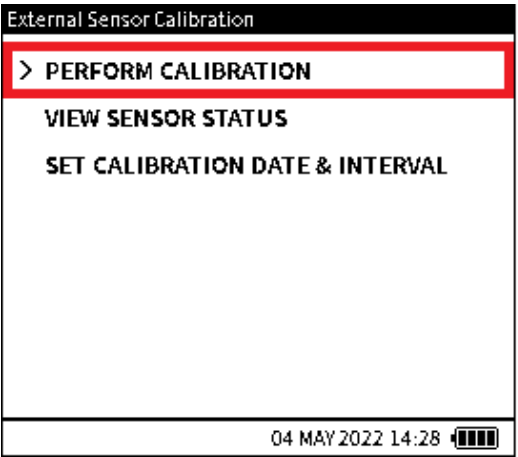
Step 1		<p>Select PERFORM CALIBRATION from the External Sensor Calibration screen.</p>
--------	---	--



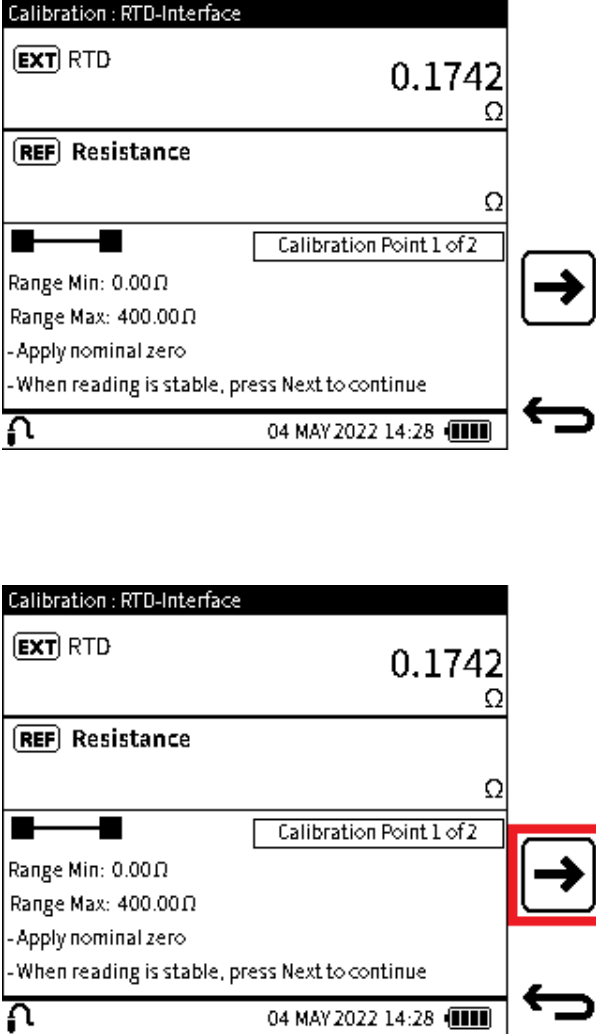
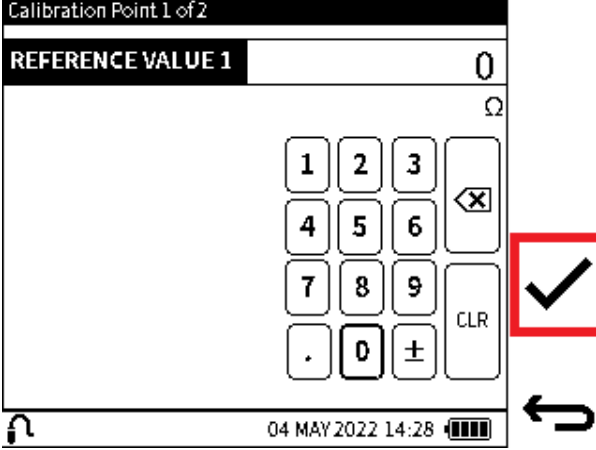



EXTERNAL RTD SENSOR CALIBRATION MENU

<p>Step 2</p>		<p>This screen has three sections. The top two sections cover:</p> <ul style="list-style-type: none"> The reference reading from external calibrated equipment. The measured (or sourced) reading from the DPI 610E. <p>The bottom section provides the following information:</p> <ol style="list-style-type: none"> Function minimum range (or negative full-scale) value. Function maximum range (or positive full-scale) value Calibration procedure step status (visual status boxes and text status) User instructions for each step of the procedure. <p>To start the calibration, apply nominal negative full-scale or zero value as per the displayed instruction. This is Calibration point 1. When the measured temperature or resistance reading is stable, select the Next icon to continue. Note: RTD sensor calibration requires two valid calibration points.</p>
<p>Step 3</p>		<p>Enter REFERENCE VALUE 1 as displayed on the external calibrated equipment. Press the Tick ✓ softkey to confirm and return to the Calibration screen.</p>

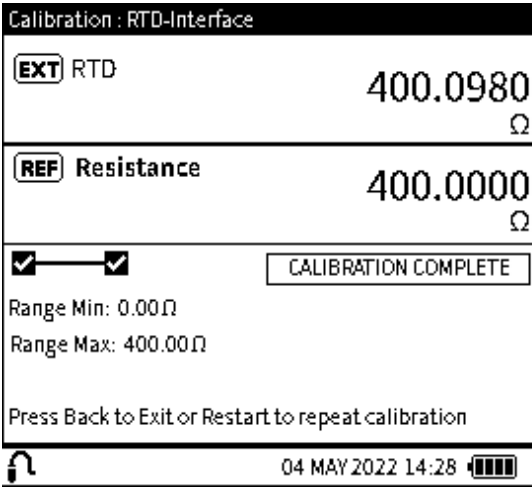
Chapter 13. Instrument Calibration

<p>Step 4</p>		<p>Press the Next softkey to complete Calibration Point 1 and proceed to Calibration Point 2.</p>
<p>Step 5</p>		<p>Repeat Steps 2 to 4, but this time begin by applying the nominal positive full-scale resistance or temperature value to the DPI 610E. This completes Calibration Point 2.</p>
<p>Step 6</p>		<p>After pressing Next from the previous step, a message window will appear, requesting confirmation to perform the calibration adjustment based on the calibration points used in the procedure. Select OK to apply the calibration adjustment. Otherwise, select the Cancel button to return to the Calibration screen</p>

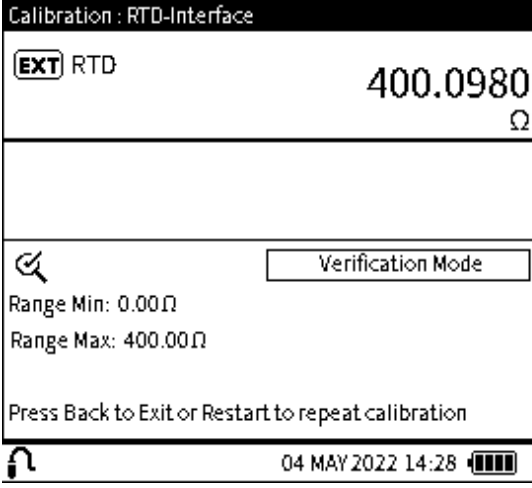
EXTERNAL RTD SENSOR CALIBRATION MENU

<p>Step 7</p>	 <p>The screenshot shows the 'Calibration : RTD-Interface' screen. It displays 'EXT RTD' with a value of 400.0980 Ω and 'REF Resistance' with a value of 400.0000 Ω. A 'CALIBRATION COMPLETE' message is shown in a box. Below this, the range is set from 0.00 Ω to 400.00 Ω. At the bottom, there is a 'Back' icon, the date '04 MAY 2022 14:28', and a battery level indicator.</p>	<p>If OK is selected, the CALIBRATION COMPLETE message appears in the status box, to confirm the adjustment has been made.</p> <p>At this stage, there are three icons for three ways to proceed. These are:</p> <ul style="list-style-type: none">  VERIFICATION softkey navigates to the Verification screen (see Step 8).  RESTART softkey allows the calibration procedure to be restarted if a repeat calibration is required.  BACK softkey exits the calibration procedure and returns the user to the Perform Calibration menu screen.
<p>Step 8</p>	 <p>The screenshot shows the 'Calibration : RTD-Interface' screen in verification mode. It displays 'EXT RTD' with a value of 400.0980 Ω. A 'Verification Mode' message is shown in a box. Below this, the range is set from 0.00 Ω to 400.00 Ω. At the bottom, there is a 'Back' icon, the date '04 MAY 2022 14:28', and a battery level indicator. A red box highlights the 'Back' icon.</p>	<p>The verification mode shows live reference and measured (or sourced) values.</p> <p>Here, different values or points within the measured (or sourced) range can be checked to verify the adjustment is satisfactory.</p> <p>Once verification is complete, select the Back  icon to exit the calibration procedure or select the Restart  softkey to repeat the calibration.</p>

Chapter 13. Instrument Calibration

13.9.2 SET CALIBRATION DATE & INTERVAL

The **External Pressure Sensor Calibration Date & Interval** screen provides the following options:

Option	Description
LAST CALIBRATION	Set the date the instrument was last calibrated
CALIBRATION INTERVAL	Enable user notification by setting the number of days between the last calibration and the next scheduled calibration (default is 365 days)
CALIBRATION DUE	Enable user notification by setting a specific date to schedule next calibration (default is based on the date of the last calibration and the specified calibration interval). This is View Only - this variable cannot be changed on this screen.

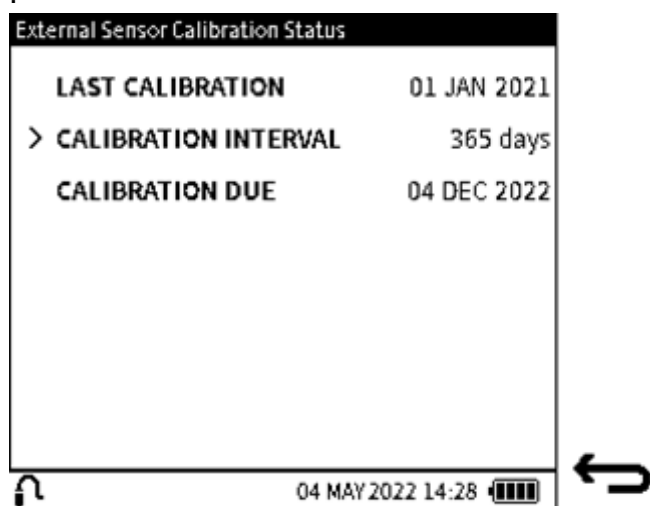

Figure 13-6: External Sensor Calibration Date & Interval Screen

To access the **External RTD Calibration Date & Interval** screen:

Step 1	<p>External Sensor Calibration</p> <p>PERFORM CALIBRATION</p> <p>VIEW SENSOR STATUS</p> <p>> SET CALIBRATION DATE & INTERVAL</p> <p>04 MAY 2022 14:28</p>	Select SET CALIBRATION DATE & INTERVAL screen from the External Sensor Calibration screen.
--------	--	--

EXTERNAL RTD SENSOR CALIBRATION MENU

13.9.2.1 Change Last Calibration Date

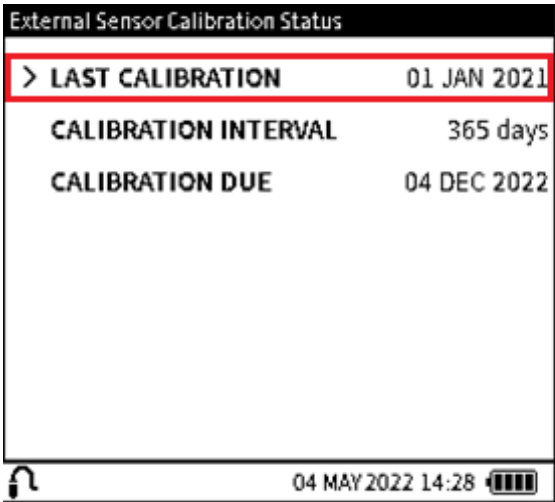
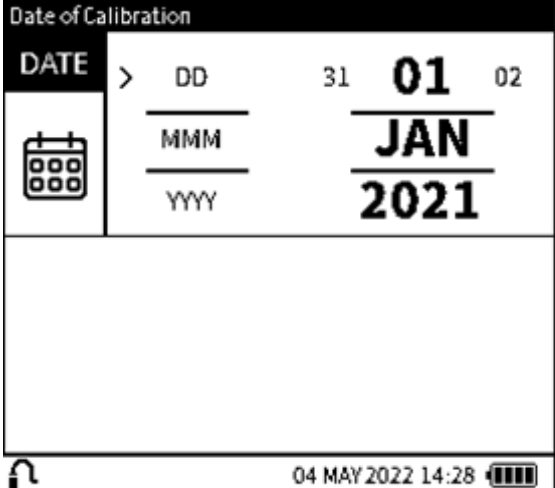
Step 1	 <p>External Sensor Calibration Status</p> <p>> LAST CALIBRATION 01 JAN 2021</p> <p>CALIBRATION INTERVAL 365 days</p> <p>CALIBRATION DUE 04 DEC 2022</p> <p>04 MAY 2022 14:28</p>	Select LAST CALIBRATION from the Instrument Calibration Date & Interval screen.
Step 2	 <p>Date of Calibration</p> <p>DATE > DD 31 01 02</p> <p>MMM JAN</p> <p>YYYY 2021</p> <p>04 MAY 2022 14:28</p>	Select the required day, month, and year, as required (see Chapter 1.19.3 on page 25). To change the value, select the row of the variable. Press the value on the left of the current value to decrease the value and the value on the right to increase the value. Repeat pressing of either left or right value decreases or increases the selected current value. Select ✓ to confirm the changes.

Chapter 13. Instrument Calibration

13.9.2.2 Change Calibration Interval

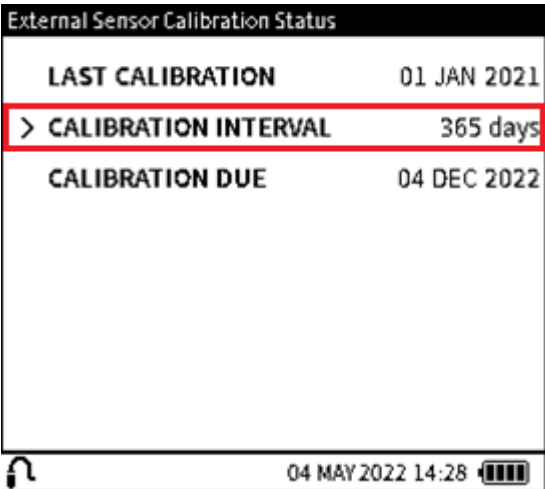
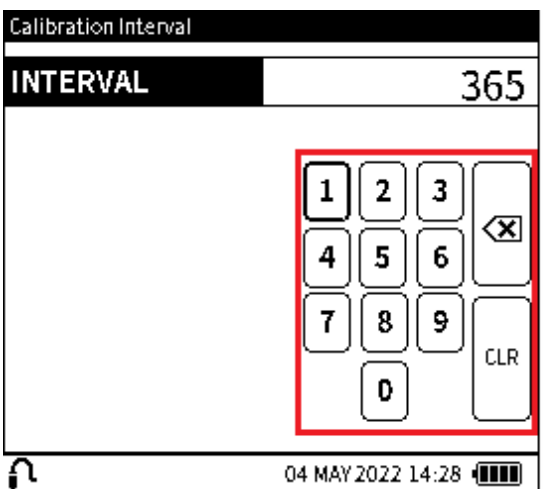
Step 1		Select CALIBRATION INTERVAL from the Instrument Calibration Date & Interval screen.
Step 2		Enter a calibration interval between 7 and 548 (days). Select ✓ to confirm.

13.9.2.3 Change Calibration Due Date

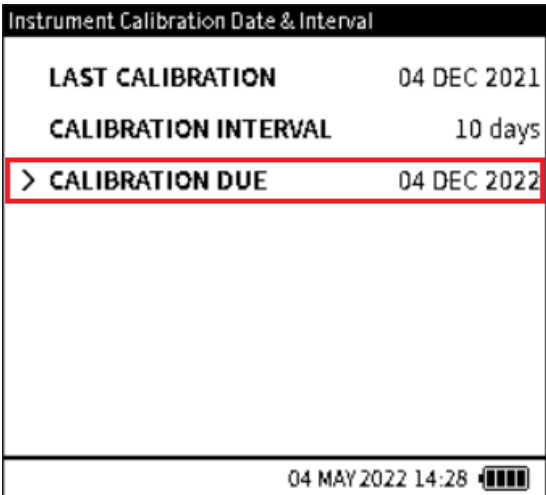
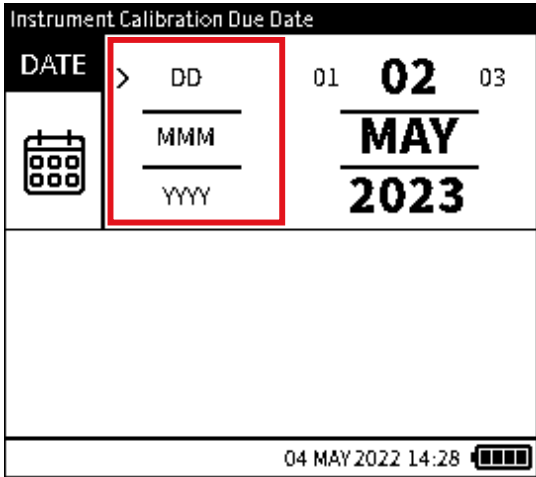
Step 1		<p>Select CALIBRATION DUE from the Instrument Calibration Date & Interval screen.</p>
Step 2		<p>Select the required day, month and year, as required (see Chapter 1.19.3 on page 25). To change the value, select the row of the variable. Press the value on the left of the current value to decrease the value and the value on the right to increase the value. Repeat pressing of either left or right value decreases or increases the selected current value.</p> <p>Select ✓ to confirm the changes.</p>

14. File System

The **Files** system menu provides access to all user files stored in the internal storage of the DPI 610E. It is accessible from the Dashboard screen and displays a structure of directories used to organize the files for easy and reliable viewing.

14.1 How to access the Files system menu

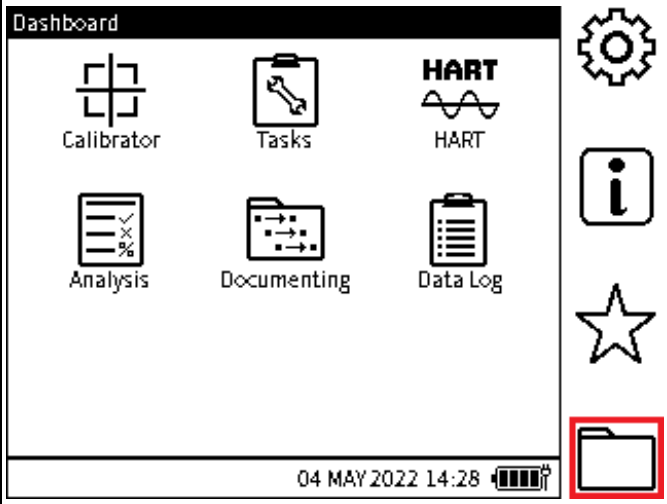
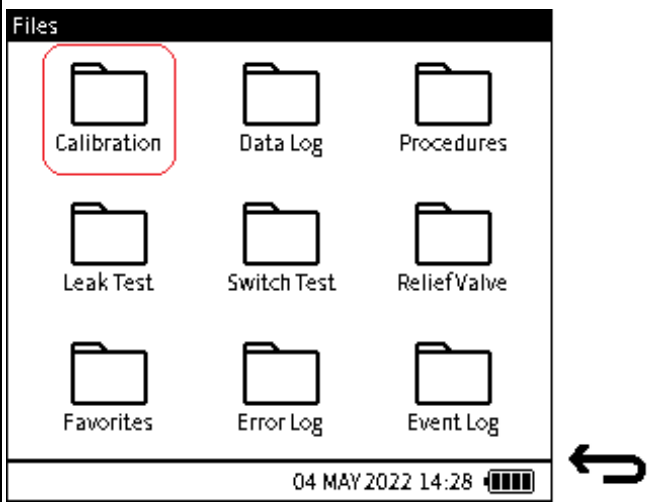
<p>Step 1</p>		<p>Select the Files softkey from the Dashboard.</p>
<p>Step 2</p>		<p>Select the required folder from the Files menu.</p>

14.1.1 The Files system screen options

Option	Description
Calibration	Export / View instrument calibration files
Data Log	View / Open / Delete data log files
Procedures	View / Delete test procedures, assets, and results files
Leak Test	View saved leak test result files
Switch Test	View saved switch test result files
Relief Valve	View saved relief valve test result files
Favorites	Proposed feature: yet to be implemented
Error Log	Export / View error log files
Event Log	Export / View event log files

14.2 Calibration

When the **Calibration** folder is selected, any previously exported calibration files will be listed. If no export has been done before, select the **Export**  softkey to generate the calibration files stored on the unit. There are three types of calibration files:

Factory Calibration – this is the default calibration carried out on the instrument in the factory prior to shipping. It is saved in persistent storage and cannot be accessed directly or deleted by the user.

Current Calibration – This is the calibration data used by the instrument at any moment in time. If the instrument is new and has not been used, the Current calibration will be the Factory calibration. Once any calibration adjustment has been done on the instrument, this new data will replace the factory calibration data as the new Current calibration. Subsequent calibrations will overwrite this user calibration data.

Backup Calibration – if the **Backup** calibration feature is used (See Section 13.5 on page 247), a copy of the Current Calibration data is saved as a Backup data file.

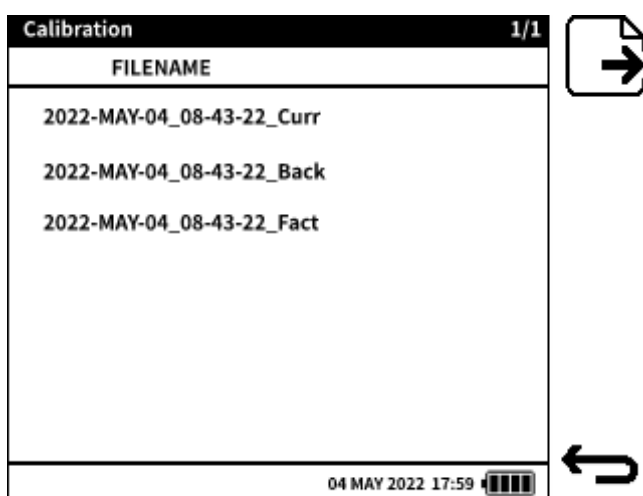



Figure 14-1: Calibration Files screen

14.3 Data Log

When the **Data Log** folder is selected, a list of log files saved on the instrument appears on its screen. The log files can be accessed, and their contents displayed from this menu.

It is also possible to delete any unwanted log files, either using the **Single Delete**  softkey which deletes single selected files, or the **Delete All**  softkey which deletes all log files present.

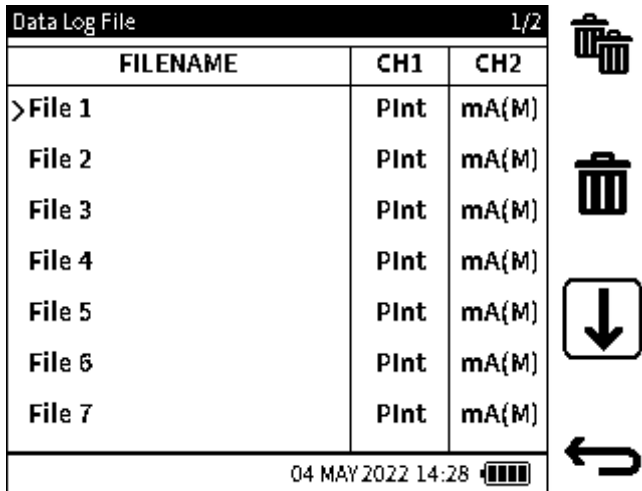



Figure 14-2: Data Log files screen

14.4 Procedures

The **Procedures** option provides a list of all test procedures created or uploaded and saved on the instrument. To view the list of available internal procedures, select the **Local Procedures** sub- folder.

Note: Only the list of files can be viewed in the **Files** application. There is the option to delete unwanted procedure files within the Local sub-folder using either the **Single Delete**  softkey to delete individual files or the **Delete All**  softkey to delete all files in the sub-folder.:

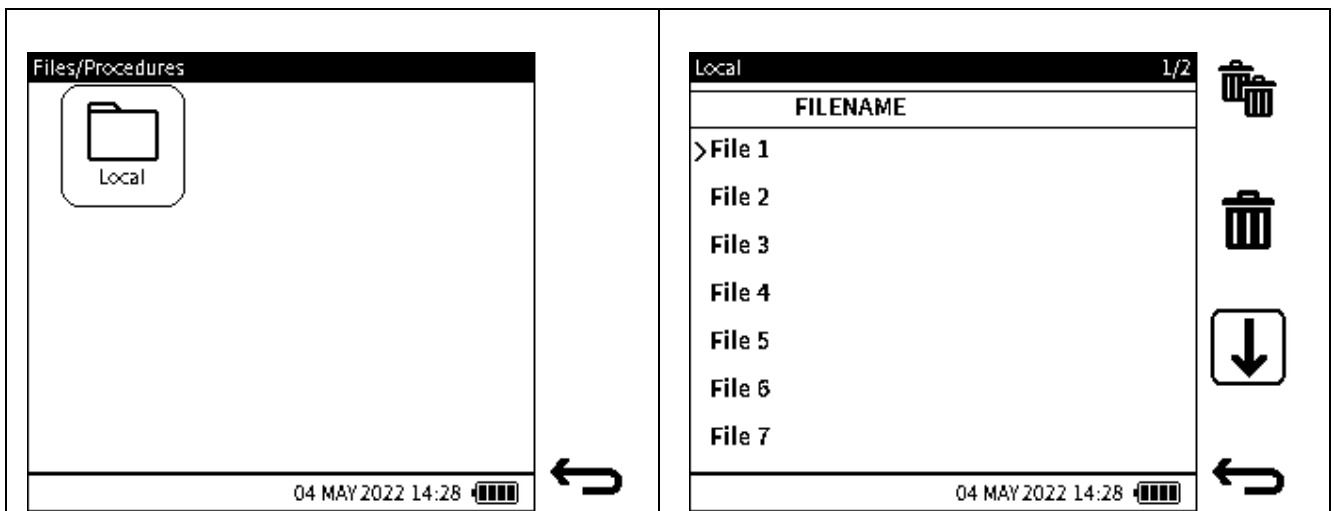

Figure 14-3: Local Procedures files

14.5 Leak Test

The **Leak Test Results** folder displays a list of saved results files from completed leak tests. This is view only, details of the test results can be viewed by opening the file on a PC.

There is the option to delete unwanted results files within the folder using either the **Single Delete**

 softkey to delete individual files or the **Delete All**  softkey to delete all files in the sub-folder.

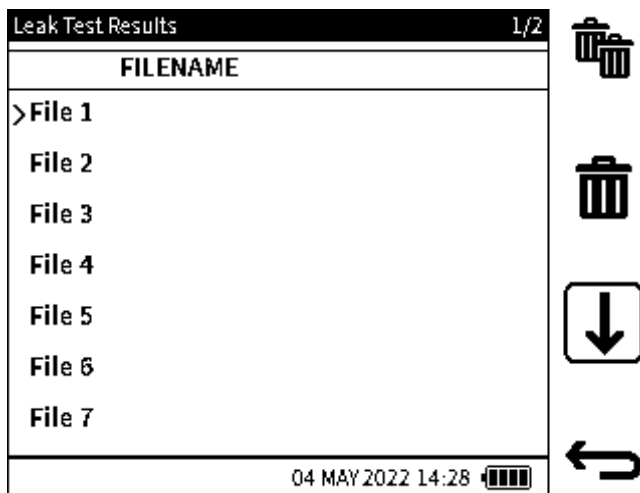

Figure 14-4: Data Log files screen

14.6 Switch Test

The **Switch Test Results** folder displays a list of saved results files from completed switch tests. This is view only, details of the test results can be viewed by opening the file on a PC.

There is the option to delete unwanted results files within the folder using either the **Single Delete**

 softkey to delete individual files or the **Delete All**  softkey to delete all files in the sub-folder.

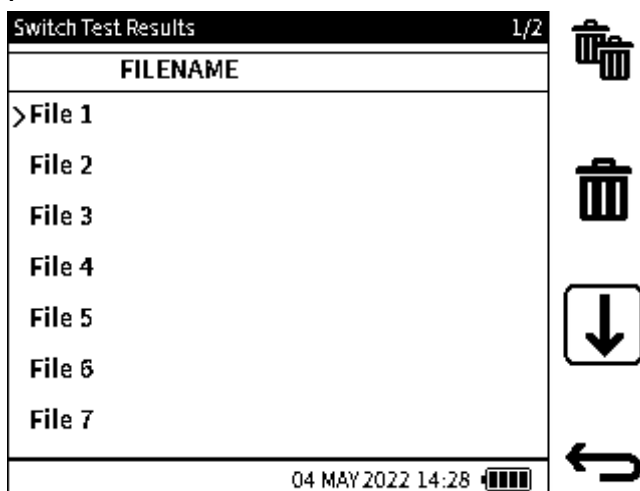



Figure 14-5: Switch Test files screen

14.7 Relief Valve

The **Relief Valve Results** folder displays a list of saved results files from completed Relief Valve tests. This is view only, details of the test results can be viewed by opening the file on a PC.

There is the option to delete unwanted results files within the folder using either the **Single Delete**  softkey to delete individual files or the **Delete All**  softkey to delete all files in the sub-folder.

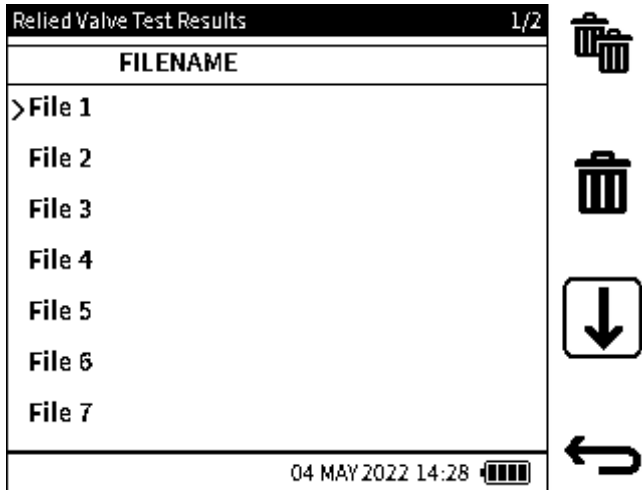

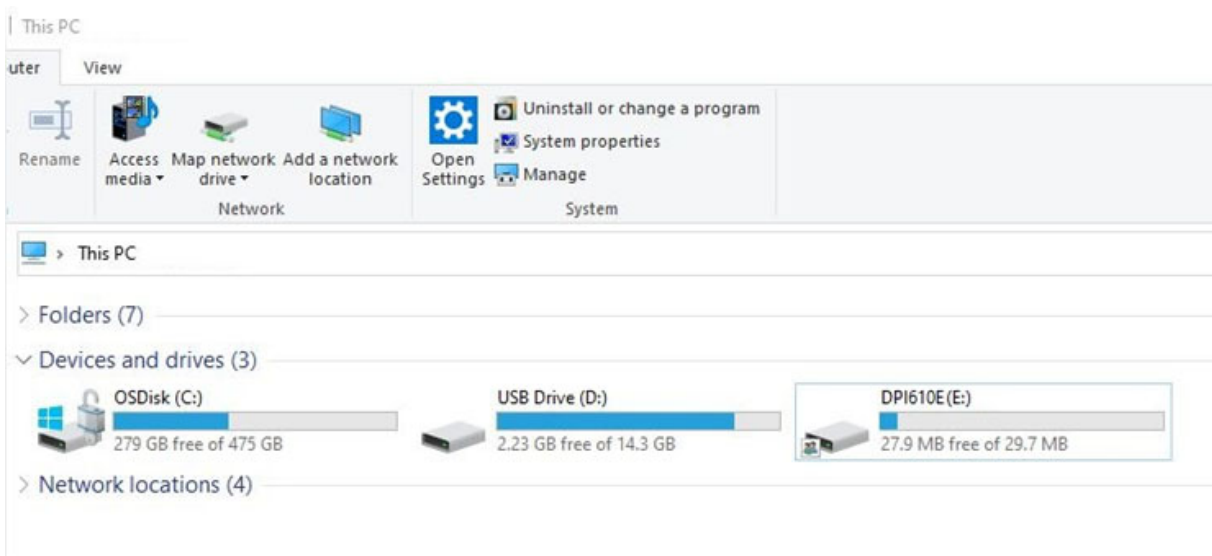

Figure 14-6: Switch Test files screen

14.8 How to view the File System on a PC

The contents of the internal storage of the DPI 610E can be accessed when connected to a PC. Connect the DPI 610E, using the micro-USB cable supplied (or any compatible mini-USB cable)

to the USB port of the PC. From the device Dashboard, select the **Settings**  softkey, then select USB. Change the USB setting to “Storage” if not already so. This allows the DPI 610E device to appear as a mass storage drive labeled “DPI610E” or “DPI610E-IS” in the Windows File Explorer on the PC.



The contents of the DPI 610E storage are similarly structured to what can be viewed on the device in terms of the folder structure.

The **HART** folder is the exception as its folder and contents can only be accessed on a PC. Files in the device storage can be copied to a different file location on the PC or can be deleted to free up space on the device.

Double-click on the DPI 610E drive and select the required **File System** folder from the root directory.

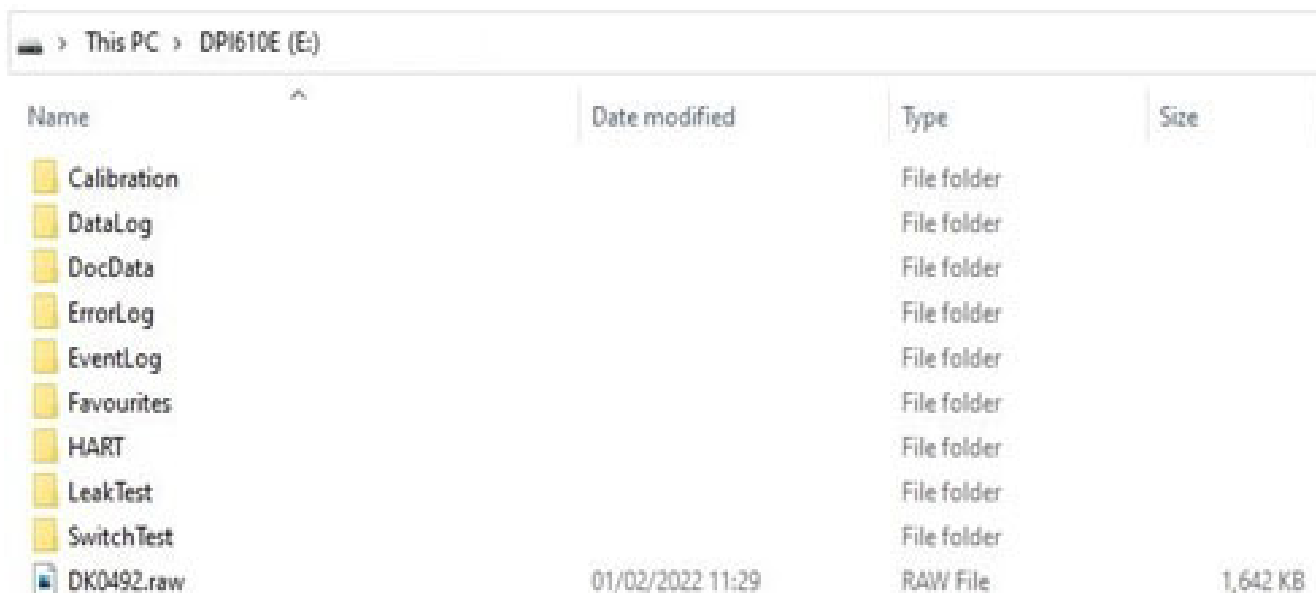

Name	Date modified	Type	Size
Calibration		File folder	
DataLog		File folder	
DocData		File folder	
ErrorLog		File folder	
EventLog		File folder	
Favourites		File folder	
HART		File folder	
LeakTest		File folder	
SwitchTest		File folder	
DK0492.raw	01/02/2022 11:29	RAW File	1,642 KB

14.9 Favorites, Error Log and Event Log

Favorites is a planned function that will be implemented in the future.

Refer to Section 15.8 on page 276 for information about how to use the **Error Log** function.

Refer to Section 15.9 on page 277 for information about how to use the **Event Log** function.

15. Status Menu

15.1 Status Menu Options

The **Status** menu is a read-only menu that provides important information about the DPI 610E instrument. It is accessible from the Dashboard and has the following view options:



Table 15-1: Status Menu Options

Option	Description
SOFTWARE BUILD	View software build installed on the instrument
CALIBRATION	View Calibration information (instrument and external sensors)
BATTERY	View battery status
MEMORY	View internal memory status
SENSOR	View Sensor information (instrument and external sensors)
ERROR LOG	Export (and view) error log files
EVENT LOG	Export (and view) event log files

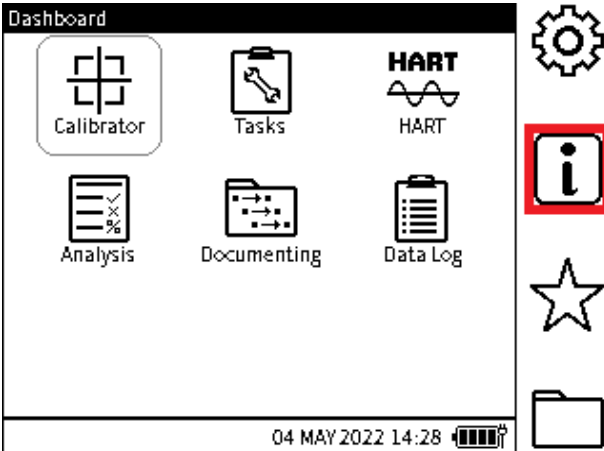
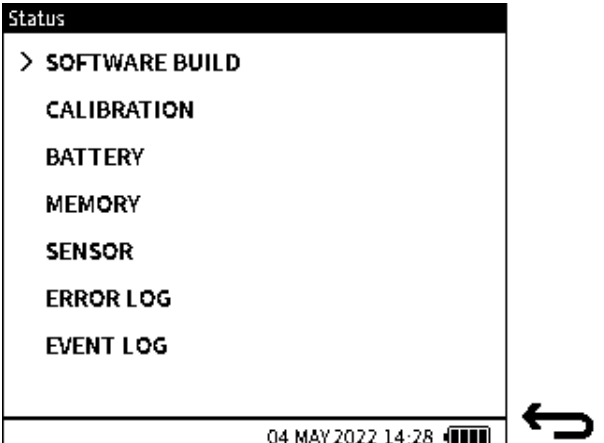

15.2 How to show the Status menu screen

<p>Step 1</p>		<p>Select the Status (Information) softkey from the Dashboard.</p>
<p>Step 2</p>		<p>A screen of Status menu options appears. To select the row that has the required option, tap on the row or use the Navigation pad.</p>

15.3 SOFTWARE BUILD

Step 1		<p>In the Status menu screen select the SOFTWARE BUILD row, to show the Status - Software Build screen.</p>
Step 2		<p>The Status - Software Build screen shows the MAIN APPLICATION (DK492) and the BOOTLOADER (DK491) build version information.</p> <p>In addition, a QR  softkey is available which when selected navigates to the programming tool information screen. This screen provides the URL and scanable QR code. This code takes the user to where the software programming tool can be downloaded with instructions on how to use it to perform software upgrades</p>

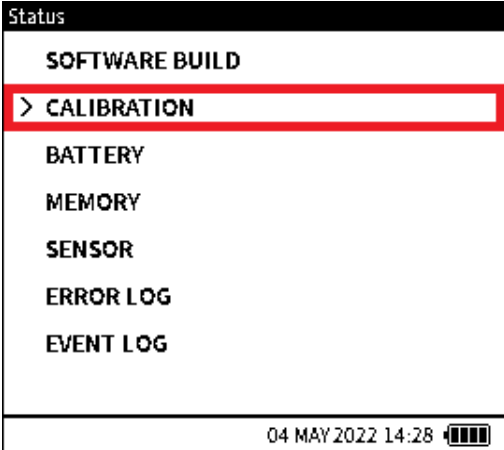
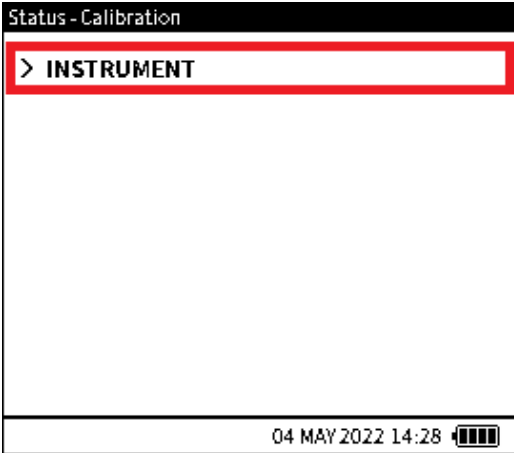
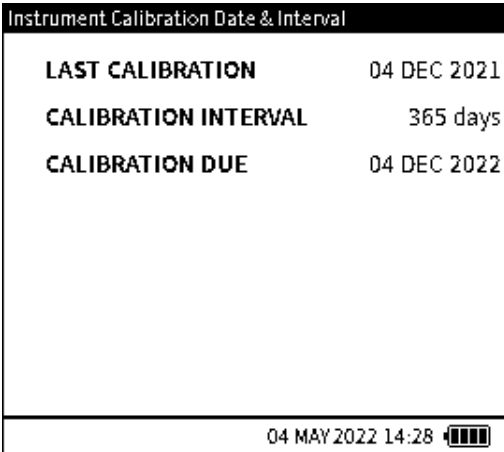
15.4 CALIBRATION

<p>Step 1</p>		<p>In the Status menu screen select the CALIBRATION row, to show the Status - Calibration screen.</p>
<p>Step 2</p>		<p>The Status - Calibration screen shows the INSTRUMENT (or sensor) option. Note: For the EXTERNAL PRESSURE SENSOR option to be available in this screen, the EXT pressure (see Section 8.1.6 on page 144) or EXTERNAL RTD function (see Section 8.2.4 on page 150) must be configured in the Calibrator menu.</p>
<p>Step 3</p>		<p>View the instrument (or sensor) details. Select the Back  softkey to return to the Status - Calibration menu</p>

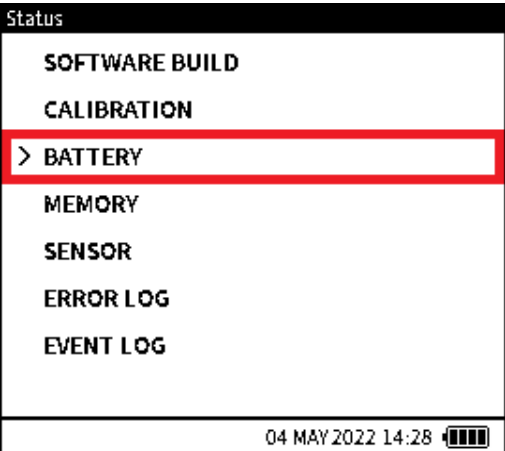
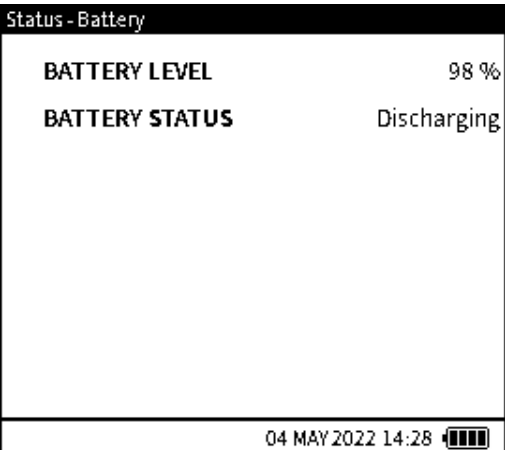

15.5 BATTERY

Step 1		In the Status menu screen select the BATTERY row, to show the Status - Battery screen.
Step 2		The Status - Battery screen shows the current instrument battery level and if the battery is either Discharging or being Charged.

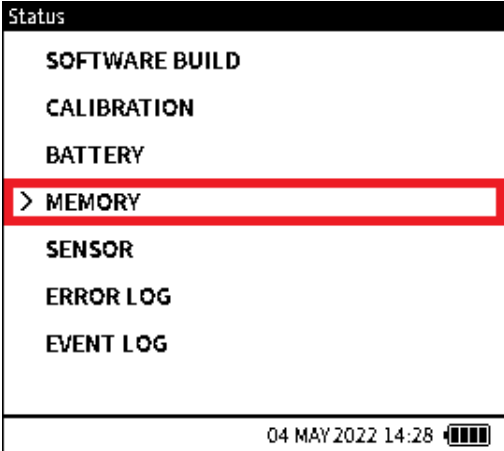
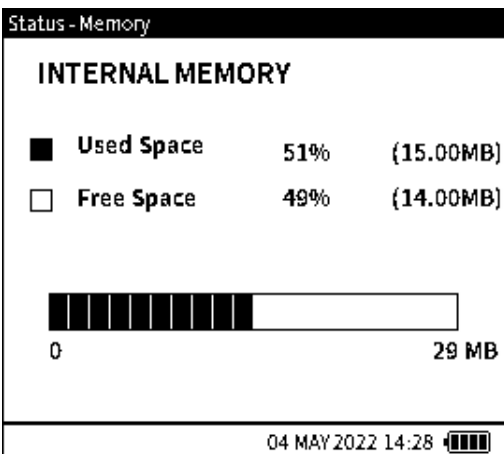
15.6 MEMORY

<p>Step 1</p>		<p>In the Status menu screen select the MEMORY row, to show the Status - Memory screen.</p>
<p>Step 2</p>		<p>The Status - Memory screen shows the current free and used space in the instrument's internal memory.</p>

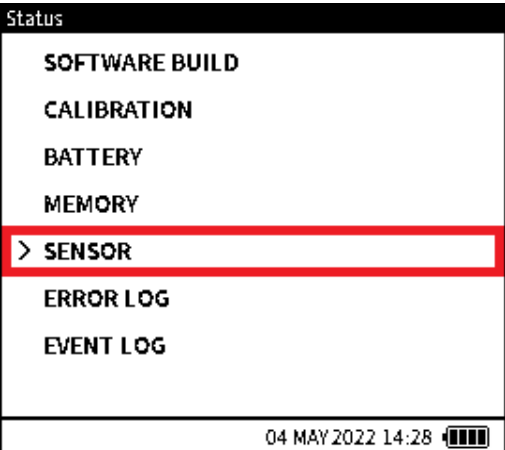
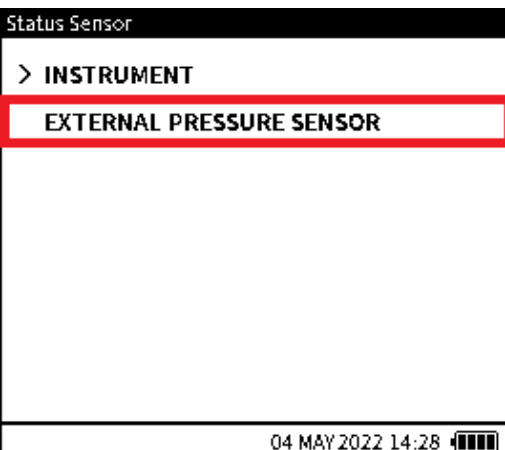
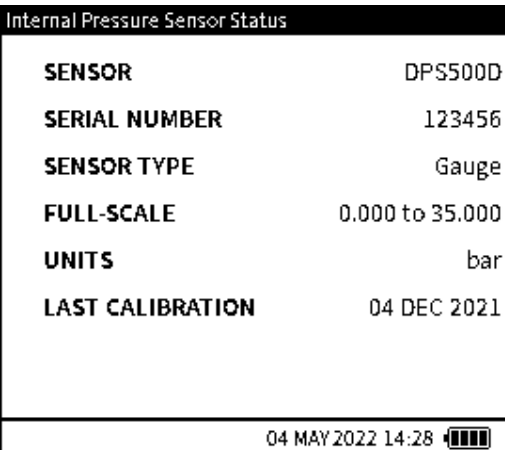
15.7 SENSOR





<p>Step 1</p>		<p>In the Status menu screen select the SENSOR row, to show the Status - Sensor screen.</p>
<p>Step 2</p>		<p>The Status - Sensor screen appears because the instrument has been configured to use an external sensor (see Section 8.1.6 on page 144.) Note: For the EXTERNAL SENSOR option to be available in this screen, the EXT pressure or RTD function must be configured in the Calibrator menu: refer to Chapter 8 on page 141 for information.</p>
<p>Step 3</p>		<p>View the sensor details. Select the Back  softkey to return to the Status - Sensor screen.</p>

15.8 ERROR LOG

The DPI 610E records detailed information whenever it encounters any operational software or firmware issues.

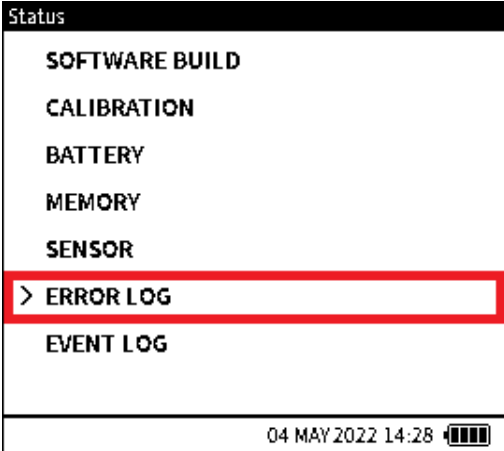
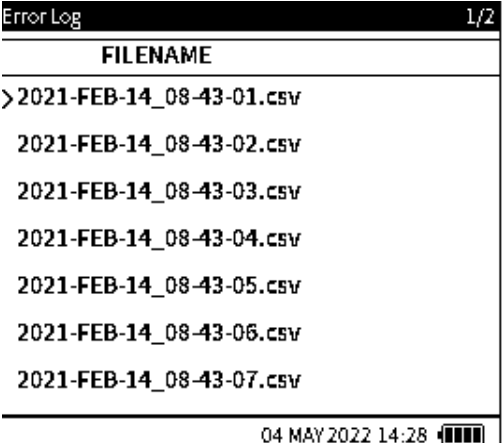
Note: Each time the **Error Log** is selected, an export of the currently logged errors is automatically created as a CSV file. This export file(s) is displayed in the **Error Log** screen but can only be opened if transferred and accessed from a PC: (refer to Section 9.6.1 on page 167 for how to find and read these files).

15.8.1 How to export and view Exported Error Log files





<p>Step 1</p>		<p>Select the ERROR LOG from the Status menu screen.</p> <p>Note: A “Please Wait” popup message will appear while the log file is being created. It may take up to 1 minute to complete.</p>
<p>Step 2</p>		<p>View the list of ERROR LOG files. To delete all files in the list, tap (or press the associated softkey) the Multiple trashcan (delete all)  icon. A message window appears asking “Delete all files?”. Select OK or Cancel.</p> <p>Press the down  icon to show one more page of available files.</p> <p>Press the Back  icon to go back to the Status screen.</p>

15.9 EVENT LOG

The DPI 610E records detailed information about significant events that occur on the instrument during operation. These events can include errors, warnings, etc.

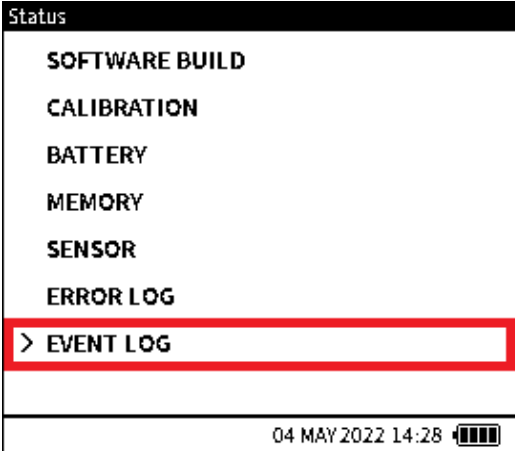
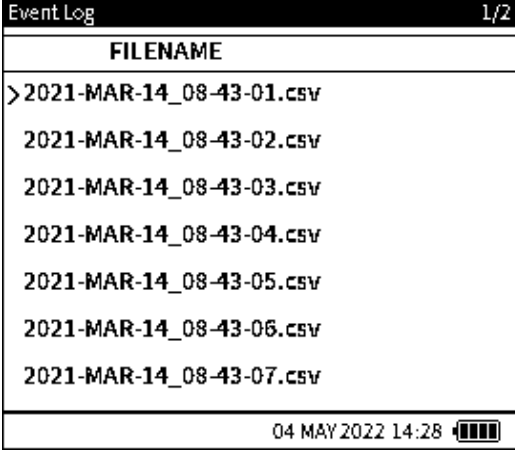
Note: Each time the Event log is selected, an export of the currently logged system events is automatically created as a CSV file. This export file(s) is displayed in the **EVENT LOG** screen but can only be opened if transferred and accessed from a PC: (refer to Section 9.6.1 on page 167 for how to find and read these files).

15.9.1 How to export and view Exported Event Log files

<p>Step 1</p>		<p>Select the EVENT LOG from the Status menu screen.</p> <p>Note: A “Please Wait” popup message will appear while the log file is being created. It may take up to 1 minute to complete.</p>
<p>Step 2</p>		<p>View the list of EVENT LOG files. To delete all files in the list, tap (or press the associated softkey) the Multiple trashcan (Delete all)  icon. A message window appears asking “Delete all files?”. Select OK or Cancel.</p> <p>Press the down  icon to show one more page of available files.</p> <p>Press the Back  icon to go back to the Status screen.</p>

16. General Specification

Refer to www.druck.com/dpi610e for the Datasheet that gives the technical specifications for the DPI 610E.

16.1 Open Source Software Licenses

Two files are available with the software installation:

1568-notices-report-08_08_2022_17_04.txt covers DK0491 DPI610E Bootloader.

1563-notices-report-08_08_2022_16_01.txt covers DK0492 DPI610E Main Application.

17. Manufacturer

17.1 Contact details

Druck Limited
2 Fir Tree Lane
Groby
Leicester
LE6 0FH
United Kingdom

Tel: +44 (0)116 231 7100
www.Druck.com

Office Locations

Headquarters

Leicester, UK
☎ +44 (0) 116 2317233
✉ gb.sensing.sales@bakerhughes.com

China

Guangzhou
☎ +86 173 1081 7703
✉ dehou.zhang@bakerhughes.com

Germany

Frankfurt
☎ +49 (0) 69-22222-973
✉ sensing.de.cc@bakerhughes.com

Japan

Tokyo
☎ +81 3 6890 4538
✉ gesitj@bakerhughes.com

UAE

Abu Dhabi
☎ +971 528007351
✉ suhel.aboobacker@bakerhughes.com

Australia

North Sydney
☎ 1300 171 502
✉ custcare.au@bakerhughes.com

China

Shanghai
☎ +86 135 6492 6586
✉ hensen.zhang@bakerhughes.com

India

Bangalore
☎ +91 9986024426
✉ aneesh.madhav@bakerhughes.com

Netherlands

Hoevelaken
☎ +31 334678950
✉ nl.sensing.sales@bakerhughes.com

USA

Boston
☎ 1-800-833-9438
✉ custcareboston@bakerhughes.com

China

Beijing
☎ +86 180 1929 3751
✉ fan.kai@bakerhughes.com

France

Toulouse
☎ +33 562 888 250
✉ sensing.FR.cc@bakerhughes.com

Italy

Milan
☎ +39 02 36 04 28 42
✉ csd.italia@bakerhughes.com

South Korea

Seongnam-si
☎ +82 31 620 6671
✉ Hyunmin.Kim@bakerhughes.com

Services and Support Locations

Tech Support

Global
✉ drucktechsupport@bakerhughes.com

France

Toulouse
☎ +33 562 888 250
✉ sensing.FR.cc@bakerhughes.com

UAE

Abu Dhabi
☎ +971 2 4079381
✉ gulfservices@bakerhughes.com

Brazil

Campinas
☎ +55 19 2104 6924, +55 19 97169 1190
✉ cc.sensing.brasil@bakerhughes.com

India

Pune
☎ +91-2135-620421~425
✉ mcindia.inhouseservice@bakerhughes.com

UK

Leicester
☎ +44 (0) 116 2317107
✉ sensing.grobycc@bakerhughes.com

China

Changzhou
☎ +86 400 818 1099
✉ service.mcchina@bakerhughes.com

Japan

Tokyo
☎ +81 3 6894 1838
✉ service.druck.jp@bakerhughes.com

USA

Billerica
☎ +1 (281) 542-3650
✉ namservice@bakerhughes.com



Copyright 2022 Baker Hughes Company. This material contains one or more registered trademarks of Baker Hughes Company and its subsidiaries in one or more countries. All third-party product and company names are trademarks of their respective holders.

156M2720 Revision - | English



bakerhughes.com