



Kaye Validator[®]

Guide to thermal validation
and temperature calibration



The Kaye Validator is a stand-alone thermal validation system that simplifies the entire validation process by reducing set-up time, minimizing sensor handling, and presenting critical study data in easily customized report formats. The Validator software now incorporates the latest technology for faster data collection, improved data management and more flexible reporting and analysis to save you significant time.

This advanced system is specifically designed to conform with 21 CFR Part 11 and meet international and European norms for validation of pharmaceutical, biotechnology and medical device manufacturing plants.

The Validator also provides precise temperature and pressure measurement capabilities for saturated steam environments.

Kaye Validator Benchmark thermal validation system



Displays online data and calculations, set-up parameters and sensor offsets.

IDs and passwords are required to start and stop a process, check configuration or calibrate sensors.

View data, calculations and messages with scroll keys.

Soft keys and menus provide versatile operation.

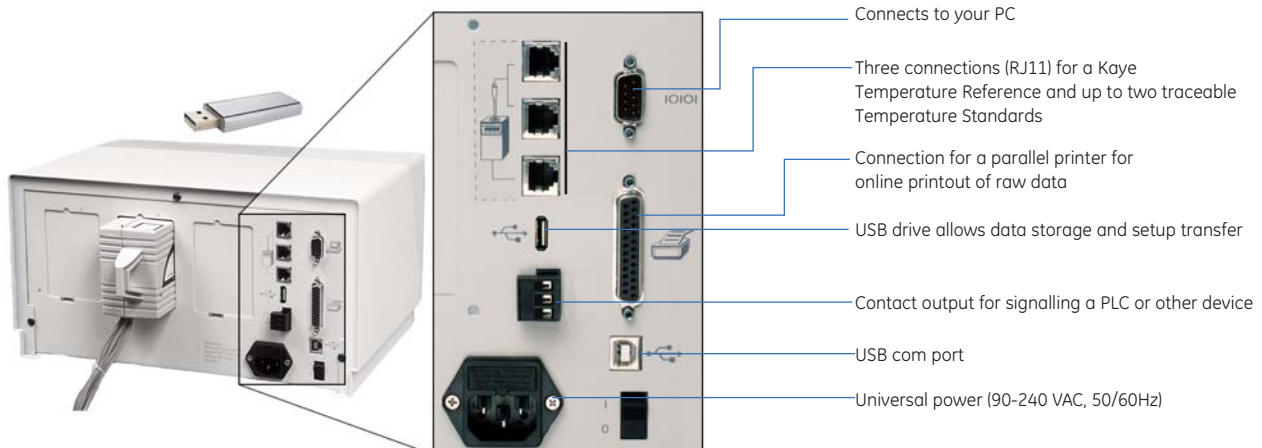

Connects to your PC

Three connections (RJ11) for a Kaye Temperature Reference and up to two traceable Temperature Standards

Connection for a parallel printer for online printout of raw data

USB drive allows data storage and setup transfer

Contact output for signalling a PLC or other device

USB com port

Universal power (90-240 VAC, 50/60Hz)



Regulatory Compliance

Electronic Records, Secure Audit Trail, and Electronic Signature

The Kaye Validator is specifically designed to enable compliance with FDA 21 CFR Part 11. All recorded data, including calibration offsets, set-up parameters, and administrative tasks are saved in secure, encrypted, tamper-proof electronic records in a format accessible only through the system software.

In addition to passwords now being centrally managed in a network-installed version, users can explicitly set permissions for each user.

With the network capability, audit trails have been improved to allow centralized management, searching and printing of department-wide audit trails from any connected PC. The sort and find utilities allow system administrators to perform thorough audits of their validator users; for example, a list of all failed login attempts within a specified time period across all networked computers.

There is notification to the user and logged entries in the audit trail if files are tampered with or deleted from within Windows Explorer™.

Validator Audit Trail 993136892 01-Oct-2004 to 15-Oct-2004
Printed on 15-Oct-2004 at 12:17:53

Time	Computer	Event	User
11:21:26		Start audit trail	Automatic Event
11:21:26		C:\PROGRAM FILES\YQ\MARKETING\VAL2\	Automatic Event
11:22:27		Program launch	Mark Ernd
11:22:27		Permission violation	Administrator accessing non-administrative function
11:22:27		Administrator accessing non-administrative function	Automatic Event
11:22:33		Program termination	Automatic Event
11:22:39		Program launch	Kaye
11:23:22		Create user	Kaye
11:23:22		May Jacobs	Kaye
11:23:38		Create user	Kaye
11:23:38		May Jacobs	Kaye
11:24:43		Audit trail access	Kaye
11:24:43		Site options modified	Kaye
11:24:43		Enforce password length (6 characters): Enabled	Kaye
11:24:43		Password length changed from 6 to 10 characters	Kaye
11:24:43		Create user	Kaye
11:24:43		Harry Smith	Kaye
11:24:48		Delete user	Kaye
11:24:48		May Jacobs	Kaye
11:24:59		Passwords backed up	Automatic Event
11:24:59		Program termination	Automatic Event
11:25:06		Program launch	Kaye
11:25:09		Program launch	Kaye
11:25:09		Preferences modified	Harry Smith
11:26:21		Temperature Units to Fahrenheit	Harry Smith
11:28:59		New setup created	Automatic Event
11:28:59		Autoclave 4 validation	Automatic Event
11:28:59		Harry Smith	Automatic Event
11:29:58		15-Oct-2001 11:29:58	Automatic Event
11:40:33		Program launch	Kaye
11:40:39		Audit trail access	Automatic Event
11:40:39		Program launch	Kaye
11:55:10		Software version change	Automatic Event
11:55:17		2.10 to 2.20	Automatic Event
11:55:17		Program launch	Harry Smith
11:56:03		Setup modified	Automatic Event
11:56:03		Autoclave 4 validation	Automatic Event
11:56:03		Harry Smith	Automatic Event
11:56:02		15-Oct-2001 11:56:02	Automatic Event
11:56:04		Program termination	Automatic Event
11:56:08		Program launch	Kaye
11:56:15		Audit trail access	Automatic Event
11:56:15		Program launch	Harry Smith
11:58:04		Program launch	Automatic Event
11:58:25		Setup downloaded to Validator	Automatic Event
11:58:25		Autoclave 4 validation	Automatic Event
11:58:25		Harry Smith	Automatic Event
11:58:02		15-Oct-2001 11:58:02	Automatic Event
12:58:50		Start qualification study	9903150
12:58:50		Autoclave 4 validation	9903150
12:58:50		Harry Smith	9903150
11:56:02		15-Oct-2001 11:56:02	Automatic Event
13:03:50		Start exposure cycle	Harry Smith
13:21:14		End exposure cycle	Harry Smith
13:22:40		End qualification study	Harry Smith
13:22:40		Login failure	Unknown user
13:26:49		Login failure	Unknown user
13:26:49		4444444444	Unknown user

User Account Creation

Three levels of authorization protect access to the system— assigning users, making changes to tests, or running tests.

Login Window

Each person has a unique signature, as defined by a user ID and password. This signature is required for any action that can affect data—at the Validator or PC—whether you are in Set-up, calibration or qualification mode.

Real-Time Process Monitoring

Monitor and Control Qualification Studies with the Instrument or the PC

The Kaye Validator can show you the entire qualification process in real time—whether you run a study using only the Validator or in conjunction with a PC.

As a stand-alone instrument, the Validator provides operator flexibility with a menu-driven display and soft keys. Scrolling through data, calculations, and messages, you can view real time or historical data. File settings such as sensor information, calculation definitions, instrument and SIM status, and summary header information are available as well.

Define Conditions for Automatic Start and Stop

Now you have more control over starting and stopping your test. You can start qualification and exposure automatically based on any calculation, input, or time of day. You can stop the process using the same criteria plus elapsed time. Start and stop can also be controlled manually.

Faster Data Storage Rate and More Choices

You can collect data as fast as one input per second, or at intervals of 2, 3, 5, 10, 20, 30, and 60 seconds or minutes, or 1, 3, 6, or 12 hours. You can also set the rate for online printing with a printer connected to the Kaye Validator.

Plug-In Modules Protect Thermocouples and Simplify Study Set-Up

A Better Way to Handle Sensors

Three Sensor Input Modules (SIMs), accommodating up to 12 sensors each, including 4/20 mA inputs, can plug into the Kaye Validator. Each SIM accepts any combination of thermocouple, voltage or current inputs such as humidity and pressure transducers. There are no fixed sensor locations—wire any sensor to any terminal. SIMs have built-in memory that store calibration offsets. This means you can store calibrated sensors that are ready to use when you need them.

The SIM contains connections for wiring sensors and a precision reference RTD to measure thermocouple junctions. During sensor calibration, a memory circuit stores the correction value for each sensor. This feature can save you time preparing for the next study. It also ensures that instrument accuracy is maintained.



A secure path for wiring sensors is provided for strain relief and organization of your probes. The wired SIM shows 10 thermocouples and one pressure sensor (a shunt resistor is used by the Kaye Validator for converting current to voltage). You can order SIMs pre-wired with thermocouple probes, labeled numerically.



The wired SIM is ready to use for either a new calibration or, if calibrated, for use in a qualification run. Plug-in SIMs let you handle up to 12 sensors at one time. A shock-resistant enclosure provides a uniform environment for your thermocouple junctions. Labels on top and sides let you write information such as calibration date or serial number of the Kaye Validator. Built-in memory retains calibration offsets. A 4/20 mA specific SIM is available for use with current loop transducers such as pressure, moisture, humidity, or CO₂.

Network Support

The software provides features to satisfy the needs of growing Validation departments in managing their Kaye validation systems.

All critical data to a validation, including passwords, audit trails, qualification, and calibration records can be automatically stored at a network location defined at software installation time by a system administrator.

At software installation, the system administrators can choose to enable network install and can predefine settings for all their users, such as password database location, data file locations, and other site options. The user will then install the software from the network and it will be automatically configured as per the system administrator's selections.

Synchronization is also supported. The user can run the validation system disconnected from the network and at the next opportunity the software will automatically update the network files and database with any changes from the disconnected session.

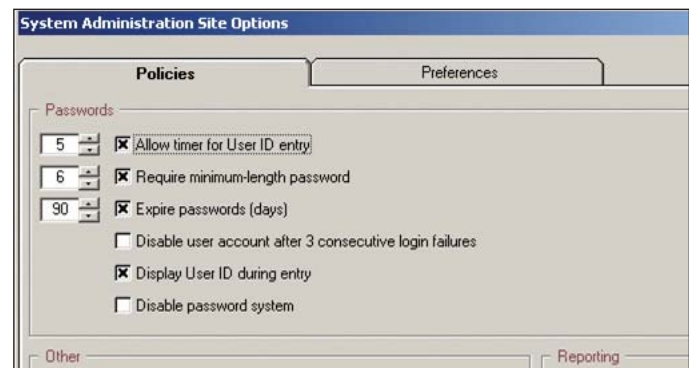

System Administration Site Options

Security policies and site options can now be selected and forced on global network basis.

Test Set-Up

Study Set-Up is Intuitive and Versatile

The Kaye Validator was designed to help you get the data you want from a validation study quickly and easily. It starts with the Validator software that allows you to set up and customize sensor calibration, qualification, and report generation.

The software lets you separate inputs by group with unique calculations and reports. The use of groups lets you organize how information is displayed and reported. For example, you can generate separate reports for distribution and penetration sensors or qualify multiple chambers at the same time.

Another view lets you easily define group test parameters including sensor assignments, calculations, comments, and the event to be monitored.

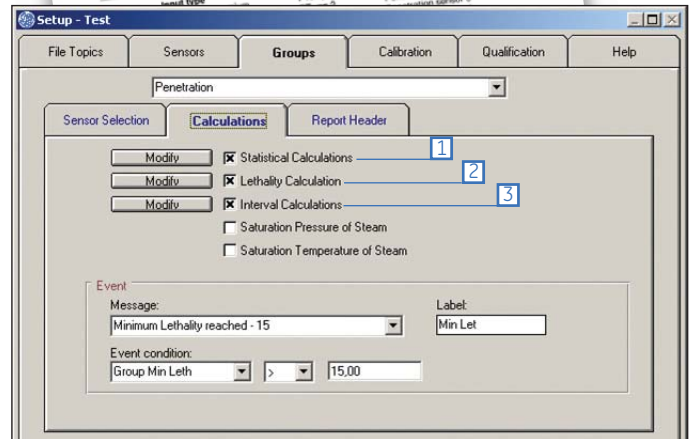
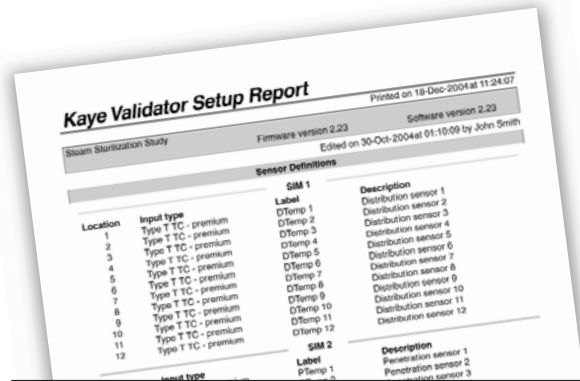

1

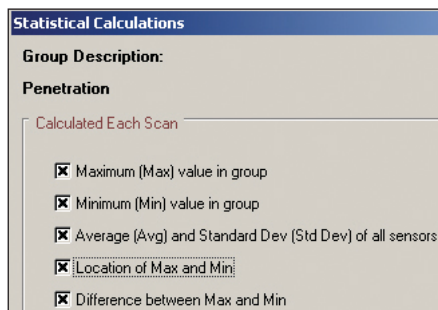

Statistical Calculations screen

Clicking on Statistical Calculations allows you to select only those you want to view during the study. Add more calculations when you're ready to generate the final report.

2

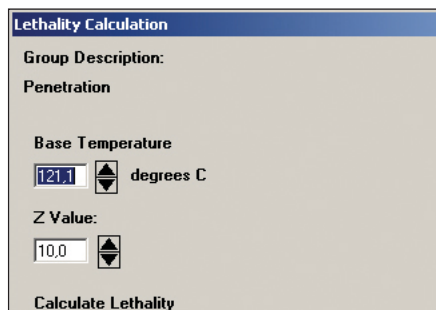

Lethality Calculations screen

Set up or modify lethality calculations by defining base temperature, Z, and D values. Select conditions when you want to calculate lethality.

3

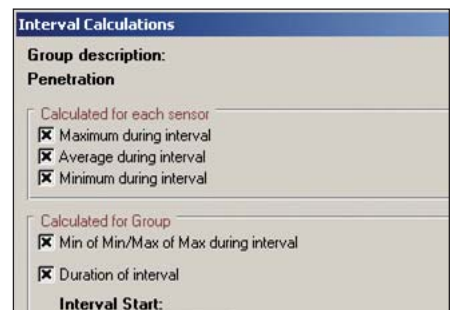

Interval Calculation screen

Within each group, the Kaye Validator can report intervals for each sensor and the group. You establish the conditions upon which the group intervals start and end.

You can customize reports right down to header information and user comments for each group. In addition, you can enter summary comments that relate to the entire study.

The Kaye Validator software provides flexibility in other ways. You can define sensors individually—creating your own labels and detailed descriptions, or applying an individual sensor definition to a range of sensors.

Featuring interval calculations and monitored events, the Kaye Validator provides more information about your study. You can calculate maximum, minimum and average for each sensor during the interval.

Users can add unlimited cycles, separating qualification data into separate process phases, and up to 25 groups, with their own calculations and graphs during reporting, often eliminating the need for post-processing in Excel®.

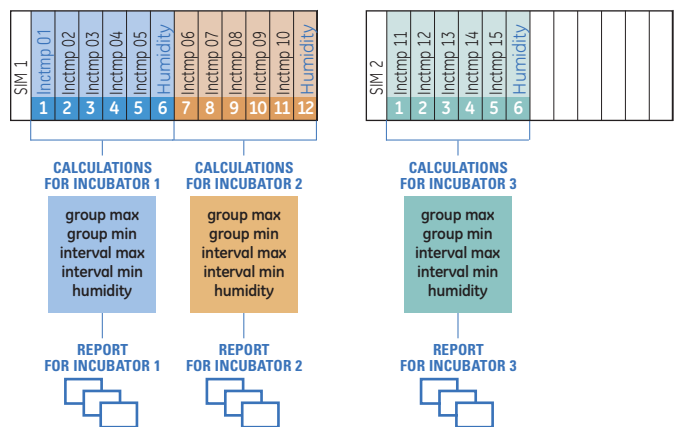

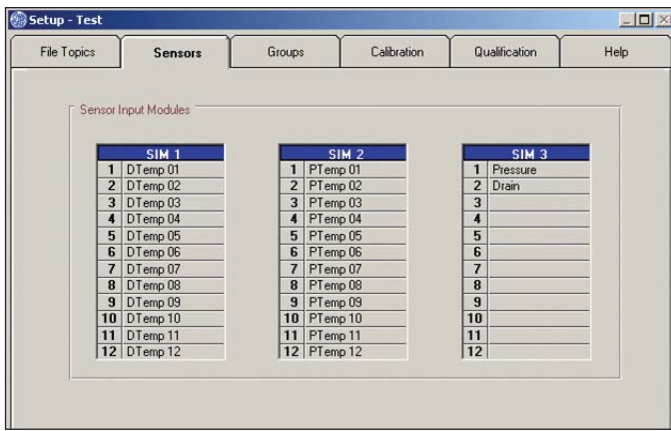

The set-up screen shows all defined sensors in the set-up. Clicking the Groups tab lets you select the sensors you want to include in a particular group.

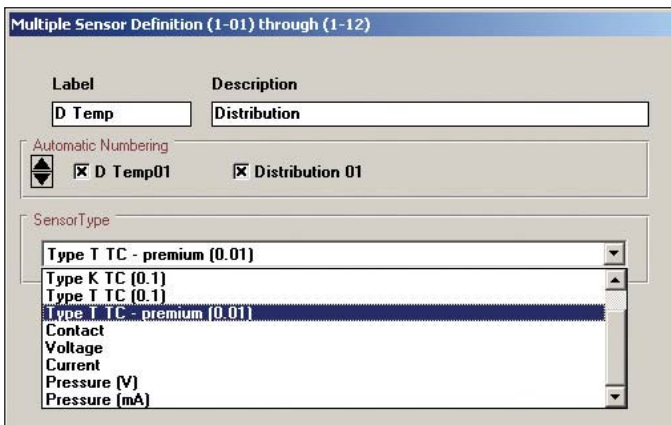

You can define each sensor individually, including a detailed description, or a range of sensors at the same time.

Reports

The Kaye reporting Software includes an intuitive, yet powerful reporting utility for generating Set-Up, Calibration, Qualification and Calibration Verification reports to document validation study results. Reports are generated from secure data files that can only be read by the system software. Upon study completion, process cycles to be analyzed are defined using the intuitive system graphic feature.

Features:

- Load set-ups, store study data and upgrade firmware via USB or Floppy
- Common reporting software for Validator®, ValProbe® and RF ValProbe® gives added flexibility and convenience in merging data files from multiple Kaye devices.
- Powerful graphing tool during reporting with report wizard shows all sensors and samples through a complete study.
- Report wizard allows to select lethality calculation also during reporting. Lethality parameters can be changed.

Post Qualification Reporting

Validator users can for the first time gain access to the flexible and user-friendly Kaye ValProbe reporting system. In addition to preserving the existing Validator group and event structure, users can now add unlimited cycles and up to 25 groups during the reporting phase.

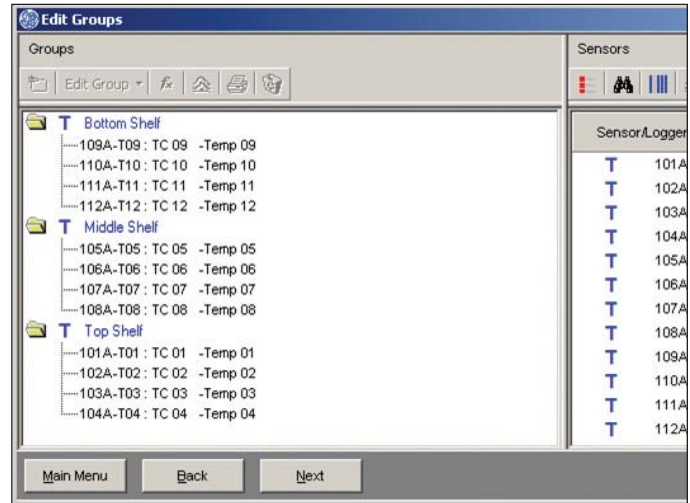

Cycles are like events—the qualification data is separated into distinct phases and summary reports can be generated for each cycle.

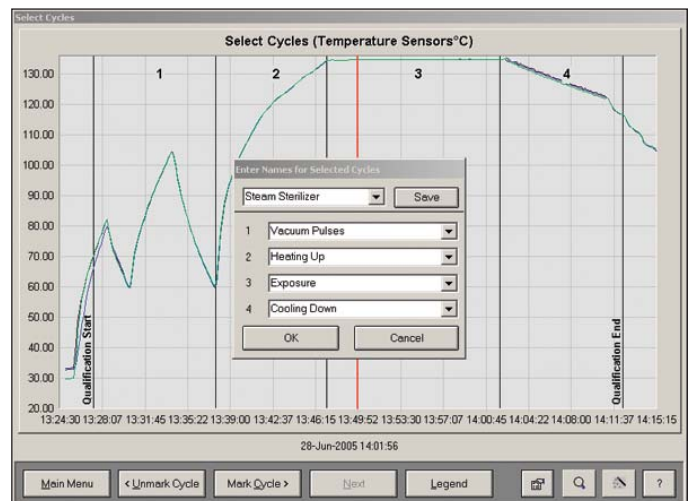

Cycle Headers

The user can generate regulatory-accepted reports including detailed and summary reports by group and cycle (interval data). Graph reports have been improved, allowing more inputs and better access to graph properties such as colors and data limit lines.

Report templates are automatically created, allowing the user to reprint an exact copy of the report at a later date, or save to a template for use in subsequent validation studies—a significant time savings for system operators.

Merged Reporting

Users have the ability to combine or merge reports from several Validators or ValProbes, providing the validations were run concurrently. A typical example would be during a freeze dryer validation where two Validators are needed, or if a ValProbe pressure logger is used alongside Validator temperatures.

For qualification reporting, the software provides more capability to analyze your study. Using various selections—calculations, intervals, events, conditions, elapsed time, specific groups—you can answer questions about your study that could only be done previously in an exported spreadsheet application.

If you need to perform additional analysis, simply open your validation file in another application. The original data is not modified.

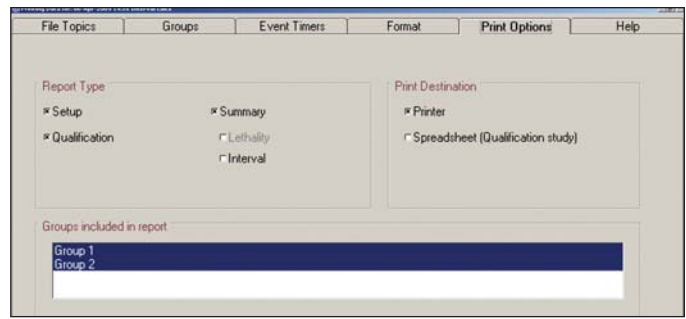

Print Options

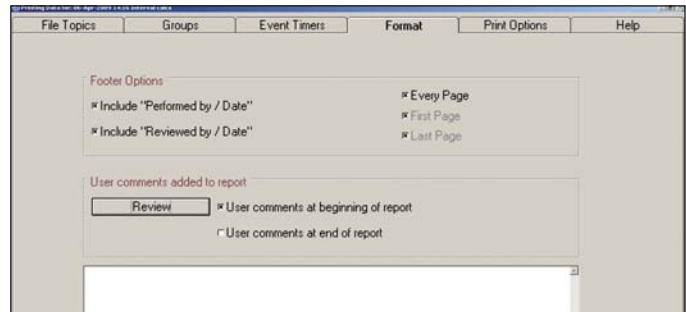

Footer Options and User Comments

SOPs require a sign off on validation reports. But SOPs vary on the number of signatures and the pages. The Kaye Validator lets you make these selections, as well as where you want user-entered notes. With the report generator you can print the information and data from an entire study, or a smaller report from one of your defined groups.

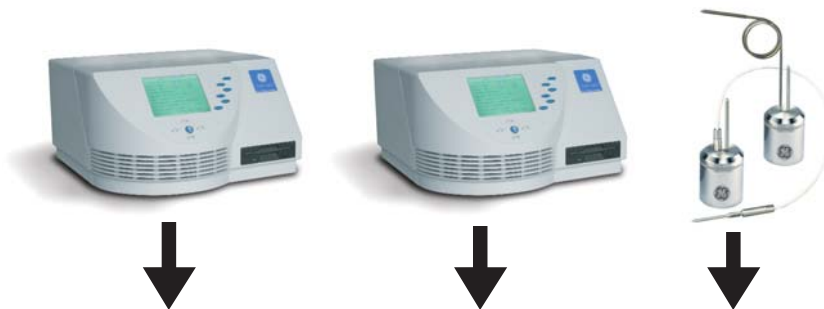

Validator - Qualification Summary Report												Printed on 11-Jul-2008 14:51:56 by GE Supervisor	
Study Name: Let calcs Min>120°C 2sec storage						SOP/Protocol #:							
												Letalit tA	
Temperature Data(C)												Totals	
Logger S/N	Heating Up				Exposure				Cooling Down				Total ALeth
	Min	Max	Avg	Cycle ALeth	Min	Max	Avg	Cycle ALeth	Min	Max	Avg	Cycle ALeth	
101A-T01 (C)	51.13	119.95	91.66	0.03	120.11	123.44	122.91	8.91	68.27	120.83	96.92	0.06	9.00
102A-T02 (C)	51.06	120.03	91.78	0.05	120.18	123.41	122.89	8.86	67.79	120.75	96.56	0.06	8.97
103A-T03 (C)	51.70	120.35	92.43	0.11	120.50	123.47	122.97	9.00	66.85	120.38	95.70	0.03	9.14
104A-T04 (C)	51.28	120.01	91.91	0.05	120.16	123.29	122.78	8.63	67.60	120.49	96.27	0.03	8.71
105A-T05 (C)	50.95	119.99	91.54	0.03	120.15	123.50	122.98	9.04	68.52	120.98	97.13	0.09	9.16
106A-T06 (C)	51.46	120.40	92.40	0.11	120.55	123.53	123.03	9.14	66.97	120.51	95.78	0.03	9.28
107A-T07 (C)	51.26	120.10	91.94	0.05	120.25	123.42	122.91	8.90	67.72	120.63	96.41	0.06	9.01
108A-T08 (C)	51.71	120.55	92.64	0.14	120.63	123.58	123.08	9.25	66.77	120.34	95.52	0.02	9.41
109A-T09 (C)	51.10	120.09	91.76	0.05	120.25	123.52	123.00	9.10	68.15	120.87	96.82	0.08	9.23
110A-T10 (C)	51.76	120.53	92.63	0.14	120.65	123.58	123.08	9.23	66.65	120.35	95.51	0.03	9.40
111A-T11 (C)	51.66	120.37	92.35	0.11	120.51	123.49	122.98	9.03	67.25	120.33	95.88	0.03	9.17
112A-T12 (C)	52.04	120.70	92.96	0.17	120.26	123.54	123.03	9.11	66.06	119.95	94.85	0.00	9.28
201A-T13 (C)	51.18	119.95	91.72	0.03	120.10	123.31	122.80	8.67	67.99	120.55	96.53	0.03	8.73
202A-T14 (C)	51.87	120.62	93.05	0.17	120.46	123.48	122.97	9.00	65.60	120.15	94.72	0.00	9.17
203A-T15 (C)	51.94	120.41	92.71	0.11	120.32	123.38	122.88	8.83	66.34	120.01	95.09	0.00	8.94
204A-T16 (C)	51.33	120.13	92.09	0.05	120.28	123.34	122.84	8.75	67.29	120.49	96.03	0.03	8.83
Temperature Summary Data(C)												Totals	
	Heating Up				Exposure				Cooling Down				
Cycle Start	10-Jul-2008 15:36:22				10-Jul-2008 15:43:48				10-Jul-2008 15:49:36				Study Start
Cycle Duration	0:07:26				0:05:48				0:03:24				10-Jul-2008 15:36:22
Min of Min	50.95 S/N 105A-T05				120.10 S/N 201A-T13				65.60 S/N 202A-T14				Study End
Time	10-Jul-2008 15:36:22				10-Jul-2008 15:43:48				10-Jul-2008 15:53:00				Duration
Max of Max	120.70 S/N 112A-T12				123.58 S/N 108A-T08				120.98 S/N 105A-T05				Min ALeth
Time	10-Jul-2008 15:43:46				10-Jul-2008 15:45:26				10-Jul-2008 15:49:36				S/N 104A-T04
Max Range	69.75				3.48				55.38				Max ALeth
Max Spread/Time	2.40 Time 15:37:38				0.98 Time 15:49:34				3.11 Time 15:52:06				S/N 108A-T08
Min ALeth	0.03 S/N 101A-T01				8.63 S/N 104A-T04				0.00 S/N 112A-T12				Study Min
Max ALeth	0.17 S/N 112A-T12				9.25 S/N 108A-T08				0.09 S/N 105A-T05				S/N 105A-T05
Avg of Avg	92.22				122.95				95.98				Study Max
Performed by:													S/N 108A-T08
Reviewed by:													

Summary report

Graphing

A powerful graphing utility within the system software greatly simplifies process analysis and reporting. Sliding vertical axes enable the operator to flag and define process transition points, eliminating unnecessary reporting and streamlining the review process. The graph utility features increased flexibility for graph customization, including specifying X and Y axis ranges, background colors, line styles and labeled limit lines.

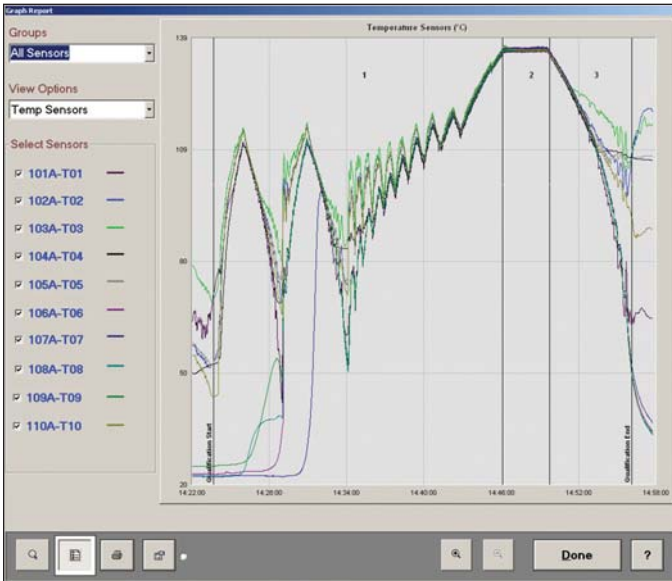

Kaye Validator powerful graphing utility

Sensor Calibration

You save time and eliminate manual methods, of sensor calibration, which results in better accuracy. By automating sensor calibration, the system reduces training requirements for your department, and makes the operation available to the non-metrologist.

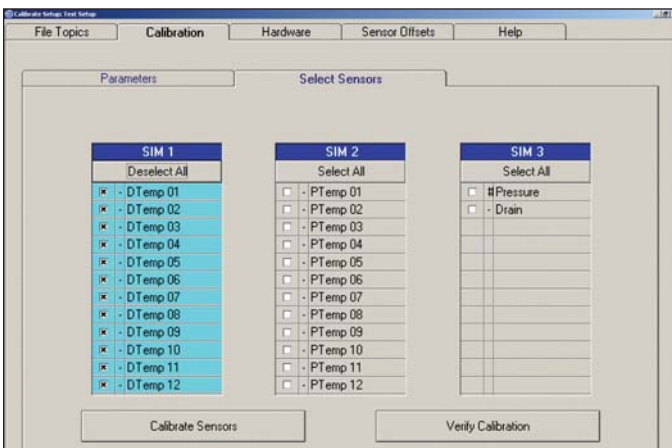

Select only the sensors you want to calibrate. Defining a calibration set lets you calibrate any number of sensors among all those wired to the system.

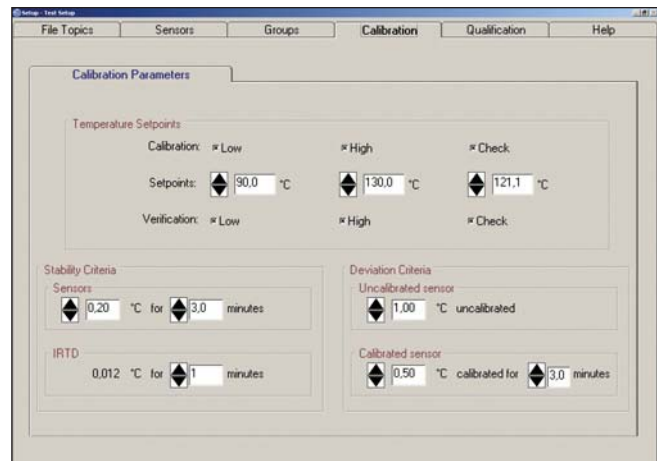

Set the criteria for a sensor calibration—low, high and check point for the actual calibration and the points to verify calibration after a study.

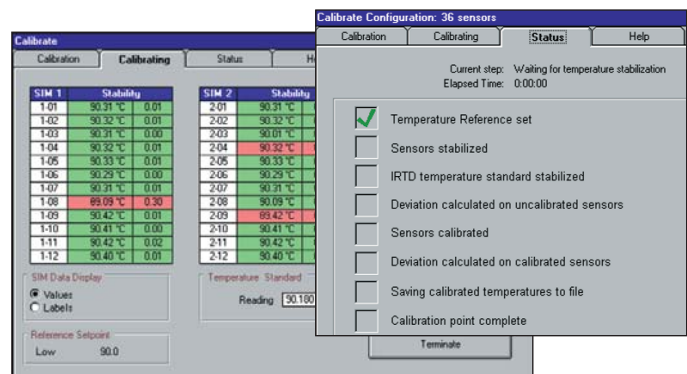

The PC shows the entire calibration process on one screen. Data fields change color to show the progress of stability and deviation for each sensor. A status screen (above, right) lists each step and indicates where the system is in the process.

Fully Automated Sensor Calibration

Sensor calibration is one of the most difficult and time consuming tasks associated with validation. The SOPs in most companies require sensor calibration before the validation study and a check afterwards to ensure the integrity and accuracy of collected data.

One Set-Up Screen to Automate Sensor Calibration

You define the set-point criteria of each sensor for calibration. Calibration can be a three-point procedure, including a two-point sensor correction and a third checkpoint.

One screen lets you specify the required calibration points (low, high, and checkpoint); select the stability criteria that thermocouples need to meet before they are calibrated; and specify the deviation criteria to ensure that out-of-range sensors are not used.

You can control and monitor a calibration from the Validator or the PC. For example, if an uncalibrated thermocouple fails if the difference between the traceable standard and the thermocouple is greater than 1.0°C. A tighter criteria of 0.5°C is used for calculating the deviation of calibrated sensors.

Checkpoint Calibration

Verifying sensor calibration, typically at the point of use, ensures all temperature measurements are within the deviation criteria.

Post Calibration Verification

After any number of qualification runs, the Kaye Validator can verify that sensor readings have not changed from their original calibration. You can define verification to be any combination of the three points used in calibration. A software check that all sensors are reading within the calibration criteria ensures that sensors have not been damaged during qualification and data is consistent.

IRTD 127.93 17834
Setpoint 130.00 Elapsed time 00:11:52

Location	Temp	Stability
1-01	128.00	0.95
1-02	128.31	0.88
1-03	128.39	0.90
1-04	128.03	0.79
1-05	128.60	0.47
1-06	127.90	1.13
1-07	128.58	0.92
1-08	127.55	1.06

View real time readings, their location and stability during stand-alone calibration. The display then changes the stability column to deviation and shows the user when each sensor meets criteria.

11:08:30 Distribution S/N 518299
G1 Inputs

Temp 01	TC-T	89.78	90.03
1-01	C	129.86	130.05
Temp 02	TC-T	89.92	90.03
1-02	C	129.64	130.05
Temp 03	TC-T	90.27	90.03
1-03	C	130.19	130.05
Temp 04	TC-T	89.97	90.03
1-04	C	130.19	130.05

Use the display to view the results of a sensor calibration including offsets stored in SIMs and read by the Kaye Validator.

Calibration verification using additional points can be automatically triggered from the PC software without changing or downloading a new setup. The calibration verification report will then combine the multiple verifications into a single report.

High Accuracy Referencing

GE's temperature calibration equipment is designed specifically to maximize overall system accuracy.

Calibration equipment includes temperature references with superior uniformity for sensors, traceable intelligent RTD standards, and validation software to communicate with the hardware.

Intelligent RTD Standard

The IRTD Temperature Standard (IRTD-400) is a NIST-traceable instrument that is calibrated over the range of -195 to 420°C. It is accurate to $\pm 0.025^\circ\text{C}$ over the entire operating range.

The IRTD-400 is a completely self-contained measurement system, containing the electronics for calibration and temperature conversion.

Communicating directly with the Validator software, the IRTD-400 eliminates the potential for human error, assuring accurate and traceable measurements.

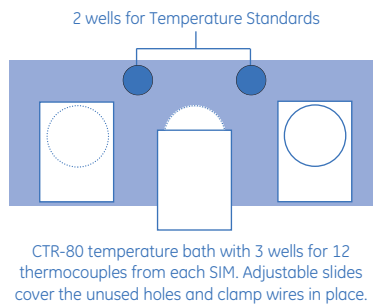
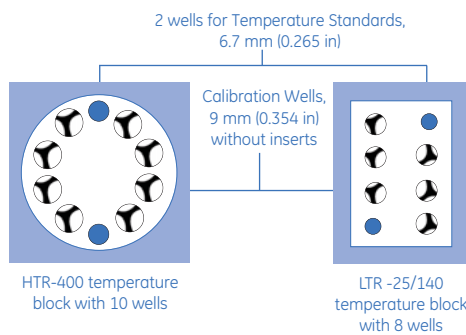

Fast/Accurate References

One temperature reference covers the temperature range for the high and low calibration point used for a typical validation study. Choose the model that best fits your need from the chart below.

Temperature dry wells employ unique inserts that minimize cooling of the thermocouple tips due to stem conduction. Without proper inserts, transfer uncertainty in excess of 0.5°C can occur with 22 gage, type T thermocouples. GE units provide an uncertainty of 0.1°C .

Calibrating over a more limited range will also increase accuracy. Since regulations require calibration for the temperature range of a process, an autoclave, for example, can be calibrated from 90 to 125°C . This method reduces the error from thermocouple characteristics to less than 0.05°C —a two-fold improvement over a calibration at 0°C and 125°C .

The temperature bath, CTR-80, provides very fast response (90 minutes from ambient to -80°C) and quiet operation. Rugged casters allow this unit to be moved with little effort. A specially designed cover supports two IRTD standards and all thermocouples from the Kaye Validator.

Temperature Reference Selection

	HTR 400 Dry Well	LTR-140 Dry Well	CTR-80 Bath
Range	50 to 400°C	-40 to 140°C and -25 to 140°C	-80 to 100°C and -40 to 150°C
Uniformity	$\pm 0.05^\circ\text{C}$	$\pm 0.05^\circ\text{C}$	$\pm 0.03^\circ\text{C}$
Application	Autoclaves, dry heat ovens, sterilization tunnels	Freezers, cold rooms, incubators, autoclaves	Freezers, cold rooms, incubators, autoclave

Kaye Validator[®]

Pressure Transducer

In order to meet the stringent requirements of EN554 and ISO-17665, it is a requirement that saturated conditions are also validated along with temperature.

An easy to use, accurate and reliable pressure transducer is available for the Kaye Validator[®] System.

Features

- Designed for the harsh environment applications such as steam sterilizers and SIP systems
- High performance pressure transducer, specified at full temperature range of autoclave
- Can be directly connected to 1.5 in triclover flange
- Full ISO-17025 traceable calibration over pressure and temperature range
- Easy to Use – wires directly to Kaye Validator[®] with no additional wiring or power supplies required.

Specifications

Type

Absolute Pressure Transducer

Range

0 bar to 4 bar (59 psia) Absolute

Sensitivity

1V to 5V

Non-linearity & hysteresis

±0.2% combined

Temp. compensated range

110°C – 140°C

Accuracy

10mbar (0.147 psi) at 110°C – 140°C

Calibration

Pressure calibration performed at 23°C and 121°C

Software Support

The Kaye Validator[®] Report Wizard provides EN554, HTM2010 and IS-17665 complaint reports.

The user can create:

- Saturated Pressure and Temperature Graph Reports utilizing temperature and pressure actual data along side calculate saturated readings
- Automatic equilibration pass/fail determination
- Automatic Tb, Tb+3 limit determination based on temperature versus saturate temperature, or pressure versus saturated pressure

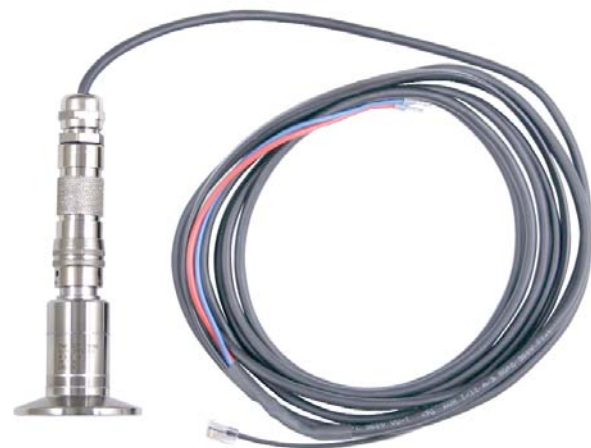

Stainless Steel Feedthru Fitting

Feedthru Fitting allows up to 18 thermocouples of any diameter to be introduced into pressure vessels such as steam or gas sterilizers, dry heat ovens and lyophilizers. Made of stainless steel with silicon rubber sealing gaskets, these TÜV –certified Feedthru is designed with no wire-damaging threads or sharp edges and is easily installed using standard 1.5 in (38.1mm) tri-clamp and gasket fittings

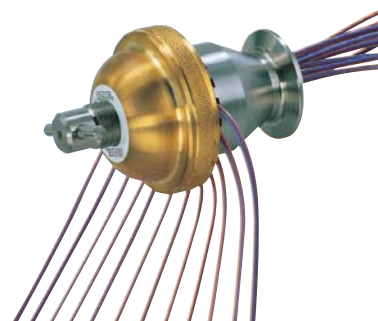

System Documentation

Quality Control Documents

GE's quality policy, the ISO 9001 implementation and certificate, and document control standard operating procedures (SOPs)

Development Procedures

Design control and project management SOPs, and functional specifications

Quality Assurance Procedures

Test plan and test case procedures

Release Documents

Quality assurance certification and product release notices

Quality Assurance Test Documentation

Quality assurance test plan and test cases

IQ/OQ Protocol

The Installation Qualification/Operational Qualification Protocol defines a set of procedures to ensure that the Kaye Validator system is properly installed and operated according to GE recommendations, and is adequately documented and controlled according to cGMP requirements. The documents are provided in hard copy and on CD, allowing users to modify the documentation to suit specific organizational requirements.

The IQ/OQ Protocol includes the following:

- Installation Qualification document
- Operational Qualification document
- Standard Operating Procedures document
- Set-up programs

Validation Reference

The Kaye Validator system is supported with documentation that verifies a fully validated system, including software, hardware and firmware. The Validation Reference Binder provides a comprehensive overview of the GE Quality Policy, description of ISO 9001 implementation and support procedures, and standards for the development, testing, and maintenance of hardware and software. Quality Control documents, Development procedures, Quality Assurance procedures, Release documents, and Quality Assurance test documentation are all included.

The Validation Reference is a serialized document, ensuring that registered users automatically receive notification and updates to keep documentation current. The result is a summary of information you would obtain by conducting an audit at GE's facility—complete, well organized, neatly packaged, and immediately accessible.



System Specifications

Total System Specifications

When you use specifications to compare equipment, be sure to establish an error budget that accounts for all possible measurement uncertainty. Sensor calibration is an integral part of validation, and total system accuracy should include potential error from the recorder, as well as the temperature reference and traceable standard.

Since all component errors are additive to the total system, every potential error is significant. A summary of the error budget for a GE validation system after sensor calibration with type T thermocouples, used at steam and dry heat, is listed below. These specifications are guaranteed under worst case conditions. Under typical operating conditions, you can expect significantly better accuracy.

Kaye Validator (resolution and short term stability)	0.017°C	k=1
IRTD Temperature Standard	0.01°C	k=1
Temperature Reference	0.051°C	k=1
Total System Uncertainty	0.078°C	k=1



Kaye Validator Specifications

Analog Input	Up to 36
Thermocouples	Type T, J, K: 0.1°C or F resolution; T limited range 0.01°C resolution
Scanning Speed	8 or 12 inputs/sec at 50/60 Hz
Internal Memory	2 Mb for data collection
Internal Battery	NiCad; 30 minutes of battery backup
Input Impedance	10KΩ. Source greater than 10KΩ produces open circuit indication
Common Mode Rejection	160 db (8 inputs/sec) @ line frequency 145 db (12 inputs/sec) @ line frequency 140 db @ DC
Max. Common Mode Voltage	100V pk ch-to-ch 350V pk ch-to-ch to frame ground
Normal Mode Rejection	82 db @ 60 Hz (8 inputs/sec) 69 db @ 60 Hz (12 inputs/sec)
Voltage Input	0 to 10 VDC
Resolution	1:72,000

Voltage Input Accuracy	30 days: $\pm(0.003\%$ of reading + 2 counts + 4 microvolts) 1 year: $\pm(0.006\%$ of reading + 2 counts + 4 microvolts)
Sensitivity	0.5 microvolts/count on most sensitive range
Voltage Temp. Coef.	$\pm(0.1$ microvolts + 0.001% reading)/°C
Compensator Temp. Coef.	$\pm 0.01^\circ\text{C}$ per °C
Input Terminal Temperature Non-uniformity	0.1°C
Input Ranges	-6 to 30mV, -60 to 300mV, -2 to 10V
Environmental	Temperature: 0 to 50°C (32 to 122°F) Relative humidity: 95% non-condensing
Power	90 to 250 VAC, 50/60 Hz
Fuse Rating	2A Slo Blo
Size	191 H x 343 W x 343 mm D (404 mm with SIM) 7.5 in H x 13.5 in W x 13.5 in D (15.9 in with SIM)
Weight	9 kg (20 lbs)

Temperature Measurement Standard (IRTD) Specifications

IRTD-400	
Temperature Range	-195 to 420°C
Accuracy Over Range ¹	0.025°C
Resolution	0.001°C
Sensor Element	100 Ω platinum sensor
Sheath Material	Inconel 600
Immersion Depth	102 mm (4 in)
Calibration ²	Traceable to NIST; recommended calibration period is one year.
Power to Probe	Unregulated DC, 10 to 25V; first probe: 850 mW at 15V; each additional probe: 550 mW
Power Supply ³	Adapter: 110 VAC US-style, or 220 VAC VDE-approved
Measurement Rate	30 readings per second
Software	IRTDWin™ software for offline use to compare IRTD probes
Environmental	Ambient temperature range: 0 to 60°C (32 to 140°F); humidity 0 to 95% non-condensing
Dimensions	Overall length: 603 mm (23.75 in); grip: 89 mm x 32 mm (3.5 in x 1.25 in) sensor sheath: 457 mm x 6.35 mm (18 in x 0.25 in)

- Notes:
1. Accurate for one year, from 0 to 60°C ambient. Includes calibration certificate with traceability to NIST.
 2. GE provides a recertification service for calibrating the Temperature Standard.
 3. Power supply is not required for use with the Kaye Validator system.



Cryo Temperature Bath Specifications

	CTR -40
Temperature Range	-40 to 150°C
Temperature Stability	±0.005°C to -40°C (ethanol) ±0.005°C to 25°C (eau) ±0.007°C to 150°C (huile 5012)
Temperature Uniformity	±0.01°C
Bath Volume	9 liters
Immersion Depth	234 mm (9.25 in)
Access Area	94 mm x 172 mm (3.7 in x 6.8 in)
Depth	234 mm (9.25 in)
Heater Power	700 watts
Cooling Rate 25 to -40°C	110 minutes, typical with ethanol
Resolution	0.01°C
Setting Repeatability	±0.01°C
Temperature Controller	24-bit digital
Display	LED w/0.01 (C° or F°) display resolution
Communications	RS-232
Safety	Over temperature limits, user settable; low voltage cutout; automatic refrigeration turn-off at 55°C
Refrigeration	R-507 single stage
Drain	Yes
Controls	Power switch; setpoint and function buttons
Power	115VAC 60Hz, 16A or 230VAC 50Hz, 8A 1700 watts
Dimensions	Off Cart: 584 mm H x 305 mm W x 622 mm D (23 in x 12 in x 24.5 in) On Cart: 819 mm H x 305 mm W x 622 mm D (32.25 in x 12 in x 24.5 in)
Weight	32 kg (78 lbs)
Certificate	Conformance certificate provided with unit.

	CTR -80
Temperature Range	-80 to 100°C
Temperature Stability	±0.03°C
Temperature Uniformity	±0.03°C
Bath Volume	1 US gallon ethanol or Halocarbon 0.8 oil (-90 to 70°C) (order ethanol locally, order oil from GE)
Immersion Depth	203 mm (8 in) max.
Access Area	108 mm ² (18 sq in), cover removed
Depth	457 mm (18 in)
Heater Power	500 watts
Cooling Rate 25 to -80°C	90 minutes, typical with ethanol
Resolution	0.01°C
Setting Repeatability	±0.01°C
Temperature Controller	24-bit digital
Display	LED w/0.01 (C° or F°) display resolution
Ramp Rate Control	0.1°C per minute to capacity of bath
Communications	RS-232 (for use with thermal validation)
Safety	Over temperature limits, user settable; low voltage cutout; automatic refrigeration turn-off at 30°C
Refrigeration	Cascade using two-1/4 HP compressors; refrigerant first stage: R507; second stage: R508B
Drain	Yes
Controls	Power switch; setpoint and function buttons
Power	115 VAC 60Hz, 16 A; or 230 VAC 50Hz, 8 A
Dimensions	762 mm H x 305 mm W x 610 mm D (30 in x 12 in x 24 in)
Weight	57 kg (125 lbs) on casters
Certificate	Conformance certificate provided with unit



	HTR 400	LTR -25/140	LTR -40/140
Temperature Range	25°C above ambient to 400°C	-25°C to 140°C	-40°C to 140°C
Ambient Operating Range	5°C to 50°C	5°C to 50°C	5°C to 50°C
Set-Point Accuracy	0.2°C to 300°C 0.3°C to 400°C	0.2°C	0.2°C
Temperature Stability	0.02°C to 300°C 0.05°C to 400°C	0.02°C	0.02°C
Transfer Calibration Accuracy*	50°C to 150°C: ±0.1°C	-25°C to 80°C: ±0.1°C	-40°C to -25°C: ±0.15°C
IRTD Standard to Thermocouples	50°C to 250°C: ±0.2°C 250°C to 350°C: ±0.3°C 350°C to 400°C: ±0.4°C	80°C to 130°C: ±0.15°C 130°C to 140°C: ±0.18°C	-25°C to 80°C: ±0.1°C 80°C to 130°C: ±0.15°C 130°C to 140°C: ±0.18°C
Typical Heat-Up Time	Ambient to 90°C: 5 minutes 90°C to 125°C: 3 minutes 350°C: 25 minutes	Ambient to 80°C: 6 minutes Ambient to 140°C: 14 minutes	Ambient to 80°C: 6 minutes Ambient to 140°C: 14 minutes
Well Configuration	Reference wells (2): 6.7 mm diameter x x 127 mm deep Calibration wells (8): 9 mm diameter x 155 mm) deep	Reference wells (2): 6.7 mm diameter x 155 mm deep Calibration wells (6): 9 mm diameter x 155 mm) deep	Reference wells (2): 6.7 mm diameter x 155 mm deep Calibration wells (6): 9 mm diameter x 155 mm) deep
Display	LED w/0.01°C resolution	LED w/0.01°C resolution	LED w/0.01°C resolution
Computer Interface	RS232	RS232	RS232
Dimensions	343 mm x 198 mm x 317.5 mm	343 mm x 198 mm x 317.5 mm	343 mm x 198 mm x 317.5 mm
Weight	8.2 kg	13.6 kg	13.6 kg
Power	115 VAC 60 Hz, 6 A or 230 VAC 50 Hz, 3 A 700 watts	115 VAC 60 Hz, 3 A or 230 VAC 50 Hz, 1.5 A 350 watts	115 VAC 60 Hz, 3 A or 230 VAC 50 Hz, 1.5 A 350 watts
Fault Protection	Sensor burnout protection, over temperature thermal cutout, electrical fuse	Sensor burnout protection, over temperature thermal cutout electrical fuse	Sensor burnout protection, over temperature thermal cutout electrical fuse

* Transfer calibration accuracy is the difference between the thermocouple tip and the sensor of the IRTD temperature standard. This accuracy includes well to well uniformity.





www.gesensing.com/kayeproducts/



imagination at work

2009 GE. All rights reserved.
BR-146A